

DIGITAL PROPORTIONAL R/C SYSTEM

T6PV



FULL MANUAL

1M23Z10802

Futaba®

INTRODUCTION

Thank you for purchasing a Futaba F-4G 2.4GHz 6PV digital proportional R/C system. This system is extremely versatile and may be used by beginners and pros alike. In order for you to make the best use of your system and to drive safely, please read this manual carefully. If you have any difficulties while using your system, please consult the manual, our online Frequently Asked Questions (on the web pages referenced below), your hobby dealer.

Due to unforeseen changes in production procedures, the information contained in this manual is subject to change without notice.

Please note that the illustrations and screen images in this manual may differ from the actual product.

<https://futabausa.com>
(<https://www.rc.futaba.co.jp>)

Application, Export, and Modification

1. This product is only designed for use with radio control models. Use of the product described in this instruction manual is limited to radio control models.
2. Exportation precautions:
 - (a) When this product is exported, it cannot be used where prohibited by the laws governing radio waves of the destination country.
 - (b) Use of this product with other than models may be restricted by Export and Trade Control Regulations.
3. Modification, adjustment, and replacement of parts: Futaba is not responsible for unauthorized modification, adjustment, or replacement of parts on this product.

OUTSIDE NORTH AMERICA

Please contact the Futaba importer in your region of the world to assist you with any questions, problems or service needs. Please recognize that all information in this manual, and all support availability, is based upon the systems sold in North America only. Products purchased elsewhere may vary. Always contact your region's support center for assistance.

Compliance Information Statement (for U.S.A.)

This device complies with part 15 of the FCC Rules. Operation is subject to the following three conditions:

- (1) This device may not cause harmful interference, and (2) This device must accept any interference received, including interference that may cause undesired operation.
- (3) RF Radiation Exposure Statement (For T6PV)

This equipment complies with FCC radiation exposure limits set forth for an uncontrolled environment. This transmitter must not be co-located or operating in conjunction with any other antenna or transmitter.

RF Radiation Exposure Statement (For R404SBS / R404SBS-E)

This equipment complies with FCC radiation exposure limits set forth for an uncontrolled environment. This equipment should be installed and operated with minimum distance 20cm between the radio and your body.

The responsible party for the compliance of this device is:

Futaba Service Center

2681 Wall Triana Hwy Huntsville, AL 35824, U.S.A.

TEL 1-256-461-9399 or E-mail: contactus@futaba.com

CAUTION:

To assure continued FCC compliance:

Any changes or modifications not expressly approved by the grantee of this device could void the user's authority to operate the equipment.

Compliance Information Statement (for Canada)

This device complies with Industry Canada license-exempt RSS standard(s). Operation is subject to the following two conditions: (1) this device may not cause interference, and (2) this device must accept any interference, including interference that may cause undesired operation of the device. This equipment complies with IC radiation exposure limits set forth for an uncontrolled environment. This transmitter must not be co-located or operating in conjunction with any other antenna or transmitter.

French: Cet appareil radio est conforme au CNR-247 d'Industrie Canada. L'utilisation de ce dispositif est autorisée seulement aux deux conditions suivantes : (1) il ne doit pas produire de brouillage, et (2) l'utilisateur du dispositif doit être prêt à accepter tout brouillage radioélectrique reçu, même sice brouillage est susceptible de compromettre le fonctionnement du dispositif. Cet équipement est conforme aux limites d'exposition aux rayonnements IC établies pour un environnement non contrôlé.

Cet équipement est conforme aux limites d'exposition aux rayonnements IC établies pour un environnement non contrôlé. Cet émetteur ne doit pas être co-situé ou fonctionner conjointement avec une autre antenne ou émetteur.

Declaration of Conformity (for EU)

Hereby, Futaba Corporation declares that the radio equipment type is in compliance with Directive 2014/53/EU.

The full text of the EU declaration of conformity is available at the following internet address:

<https://www.rc.futaba.co.jp/english/dl/declarations.html>

Table Of Contents



- Safety Precautions 6
- Explanation Of Symbols 6
- 2.4GHz System Precautions 6
- Receiver Mode Precautions 6
- Operation Precautions 7
- Option Battery Handling Precautions 7
- Storage And Disposal Precautions ... 8
- Other Precautions 8
- Features 9
- Set Contents 10
- Specifications 10
- Transmitter T6PV Nomenclature 11
- Power & Display Switch 12
- Display When Power Switch Is Turned On 12
- Power Off Forgotten Alarm & Auto Power Off 13
- Low Battery Alarm 13
- Steering Wheel And Throttle Trigger Operation 13
- Digital Trim Operation 14
- Trim/Dial Lock 15
- Mechanical ATL Adjustment 15
- Wheel & Trigger Tension Adjustment 16
- Trigger Slide Adjustment 16
- SW: Push switch DL: Dial 17

- Optional Grip Rubber 17
- Optional Carbon Handle 17
- Battery Replacement Method 18
- Low Battery Alarm 18
- When Using The Optional Battery 19
- Optional NiMH LiFe Battery Replacement Method..... 19
- Optional LiPo Battery LT2F2000B Replacement Method..... 20
- When Charging For The Optional LiPo Battery 20
- Steering Wheel Arrangement 21
- Exchange procedure to wheel adaptor 32 deg and large diameter wheel 22
- Installing the accessory APA steering wheel offset adapter 23
- Angle Spacer 25
- Trigger Brake Lever Replacement 26
- Handling The Antenna 26
- Receiver Terminology 27
- Receiver Installation 27
- Receiver and Servo Connections 28
- Installation Safety Precautions ... 29
- Menu Selection 31
- Display Menu Screen 31
- Calling the endpoint screen / Returning from the endpoint screen to the home screen 31
- Jog key/DIR/END Button 32

Table Of Contents



● Value Of Each Function And Changing The Set Value 33	● Kyosho MINI-Z EVO2 82044 (RA-51), 82046(RA-53) Link 64
● Linking Method For F-4G System 34	● Kyosho MINI-Z FS-RM005 module Link 67
● Function Map 37	● Servo view 69
SYSTEM MENU 39	● Throttle mode (Trigger) 70
● Display 39	● Channel reverse 72
● Information 40	● Sub trim 73
● Buzzer 42	● End point 74
● Battery 43	● Fail-safe/Battery fail-safe 77
● Total time 44	● Acceleration 79
● LED setting 45	● Trim/Dial select 81
● Calibration 46	● Switch select 84
● Receiver update 48	● Idle-up 87
MODEL MENU 50	● D/R, ATL 89
● Model select 50	● Channel setting 91
● Model copy 51	RACING MENU 92
● Model name 53	● Curve (EXP) 92
● Model delete (Model saved on microSD card) 54	● Speed 97
● Data reset 55	● Traction control 101
● Model type 56	● A.B.S. 105
LINKAGE MENU 57	● Start 110
● Receiver 57	● Engine cut 112
● Linking Method For F-4G System 57	● Response 114
● T-FHSS Link 60	● Drag racing 115
● S-FHSS Link 62	MIXING MENU 116
● Kyosho MINI-Z EVO 82042 (RA-42) Link 63	● Steering mixing 116

Table Of Contents

T6PV

● Brake mixing	120
● Gyro mixing	124
● 4WS mixing	127
● Dual ESC	130
● CPS mixing (1, 2, 3)	132
● Tank mixing	134
● Program mixing (1, 2, 3, 4, 5)	136
● Winch mixing	140

TELEMETRY MENU	142
● Telemetry system	142
● Telemetry	143
● Telemetry: Receiver battery voltage	144
● Telemetry: The drive battery voltage	145
● Telemetry: RPM	146
● Telemetry: Temperature	147
● Telemetry: The drive battery electric Current	148
● Telemetry: MC/AcuVance	150
● Sensor list	152
● Sensor	154
● Sensor Reload	155
● Sensor Register	156
● Change Slot	157
● Logging interval	158



ACCESSORY MENU	159
● Timer	159
● Using the Up timer	162
● Using the fuel down timer	163
● Using the lap timer	164
● Using the lap navigate timer	165
● Lap list	166
● S.BUS servo	167
● UR servo setting change procedure	173
● S.BUS function setup	175
● MC (ESC) link	177
● Gyro link	188
● Gyro data switching function	192
● Roll out chart	193
● Gear ratio chart	194
● END/DIR button setting	195
● Home screen setting	196
● User menu setting	198
● REAL TIME ICS MiniZ	199
● Warning displays	201
● WARRANTY & REPAIR service (in U.S.A.)	202



Use this product in a safe manner. Please observe the following safety precautions at all times.

Explanation Of Symbols

For safety's sake, pay special attention whenever you see the marks shown here.



For safe use

 Danger	Procedures which may lead to dangerous conditions and cause death/serious injury if not carried out properly.
 Warning	Procedures which may lead to a dangerous condition or cause death or serious injury to the user if not carried out properly, or procedures where the probability of superficial injury or physical damage is high.
 Caution	Procedures where the possibility of serious injury to the user is small, but there is a danger of injury, or physical damage, if not carried out properly

Symbols:  : Prohibited  : Mandatory

2.4GHz System Precautions

Warning

-  Special attention should be paid before turning on the system while other cars are running or other airplanes are flying because the 2.4GHz RC system could potentially affect them.
-  Be sure to set the Fail-safe function.

Receiver Servo Mode Precautions

Caution

-  **Be sure to match the operation mode for both the servos and transmitter.**

Please adjust the receiver settings on the transmitter according to the servo you are using and its operating mode (UR/SR/digital/analog). (For each channel) If the settings are not correct, it may damage the servo, battery, etc.. Please use Futaba genuine products as Futaba won't cover the damage caused by using other brand servos or peripherals such as extension cable, etc..

- For servos for which the operation mode can be set, change the servo operation mode according to the system to be used. If the operating modes of the system and servo are different, it will fail.
- Use UR servo (Set to UR mode) for UR mode. Use SR servo (Set to SR mode) for SR mode.
- When the UR(SR) mode is ON, it is exclusively for our UR(SR) compatible servo. Using a servo other than the UR(SR) compatible servo may cause the servo or receiver to malfunction.
- If a normal servo is connected to a CH with UR/SR mode ON, there is a risk of damage.
- Do not connect UR/SR servo (set to UR/SR mode) and analog servo in digital servo mode.
- Do not connect UR/SR servo (set to UR/SR mode) in analog servo mode.
- UR/SR servo can be used with digital or analog mode of the transmitter when the servo set to "normal" mode.
- Connecting an UR/SR mode compatible servo set to UR/SR mode to the S (S.BUS2 port) may cause malfunction of the servo or receiver.
- Receiver battery: Matched to the ratings of the receiver and connected servo (dry cell battery cannot be used).
- Fail-safe Unit cannot be used because the system is different. Use the fail-safe function of the transmitter.

Operation Precautions

Warning

Do not operate outdoors on rainy days, run through puddles of water or use when visibility is limited.

Should any type of moisture (water or snow) enter any component of the system, erratic operation and loss of control may occur.

Do not operate in the following places.

- Near other sites where other radio control activity may occur.
- Near people or roads.
- On any pond when passenger boats are present.
- Near high tension power lines or communication broadcasting antennas.

Interference could cause loss of control. Improper installation of your Radio Control System in your model could result in serious injury.

Do not operate this R/C system when you are tired, not feeling well or under the influence of alcohol or drugs.

Your judgment is impaired and could result in a dangerous situation that may cause serious injury to yourself as well as others.

Do not touch the engine, motor, speed control or any part of the model that will generate heat while the model is operating or immediately after its use.

These parts may be very hot and can cause serious burns.

Always perform an operating range check prior to use.

Problems with the radio control system as well as improper installation in a model could cause loss of control.

(Simple range test method)

Have a friend hold the model, or clamp it down or place it where the wheels or prop cannot come in contact with any object. Walk away and check to see if the servos follow the movement of the controls on the transmitter. Should you notice any abnormal operation, do not operate the model. Also check to be sure the model memory matches the model in use.

Turning on the power switches.

Always check the throttle trigger on the transmitter to be sure it is at the neutral position.

1. Turn on the transmitter power switch.
2. Turn on the receiver or speed control power switch.

Turning off the power switches

Always be sure the engine is not running or the motor is stopped.

1. Turn off the receiver or speed control power switch.
2. Then turn off the transmitter power switch.

If the power switches are turned off in the opposite order, the model may unexpectedly run out of control and cause a very dangerous situation.

When making adjustments to the model, do so with the engine not running or the motor disconnected.

You may unexpectedly lose control and create a dangerous situation.

Before running (cruising), check the fail-safe function.

Check Method;

Before starting the engine, check the fail-safe function as follows:

- 1) Turn on the transmitter and receiver power switches.
- 2) Wait at least one minute, then turn off the transmitter power switch. (The transmitter automatically transfers the fail-safe data to the receiver every minute.)
- 3) Check if the fail-safe function moves the servos to the preset position when reception fails.

The fail-safe function is a safety feature that minimizes set damage by moving the servos to a preset position when reception fails. However, if set to a dangerous position, it has the opposite effect. When the reverse function was used to change the operating direction of a servo, the fail-safe function must be reset.
Setting example: Throttle idle or brake position

Option Battery and charger Handling Precautions

Warning

Never plug the charger into an outlet of other than the indicated voltage.

Plugging the charger into the wrong outlet could result in an explosion or fire.

Never insert or remove the charger while your hands are wet.

You may get an electric shock.

Do not use the T6PV transmitter's battery as the receiver's battery.

Since the transmitter's battery has an overload protection circuit, the output power will be shut down when the high current load is applied. This may result in runaway or fatal crash.

Always check to be sure your batteries have been charged prior to operating the model.

Should the battery go empty while the model is operating, loss of control will occur and create a very dangerous situation.

To recharge the transmitter battery, use the special charger made for this purpose.

Overcharging could cause the battery to overheat, leak or explode. This may lead to fire, burns, loss of sight and many other types of injuries.

Caution

Do not use commercial AA size NiCd and NiMH batteries.

May cause the battery contacts to overheat and damage the battery holder.

⊘ **Do not short circuit the battery terminals.**

A short circuit across the battery terminals may cause abnormal heating, fire and burns.

⊘ **Do not drop the battery or expose it to strong shocks or vibrations.**

The battery may short circuit and overheat; electrolyte may leak out and cause burns or chemical damage.

ⓘ **When the model is not being used, always remove or disconnect the battery.**

Leaving the battery connected could create a dangerous situation if someone accidentally turns on the receiver power switch. Loss of control could occur.

ⓘ **Always keep the charger disconnected from the outlet while it is not in use.**

Storage And Disposal Precautions

⚠ Warning

⊘ **Do not leave the radio system or models within the reach of small children.**

A small child may accidentally operate the system. This could cause a dangerous situation and injuries. Batteries can be very dangerous when mishandled and cause chemical damage.

⊘ **Do not throw batteries into a fire. Do not expose batteries to extreme heat. Also do not disassemble or modify a battery pack.**

Overheating and breakage will cause the electrolyte to leak from the cells and cause skin burns, loss of sight, and other injuries.

ⓘ **When the system will not be used for any length of time, store the system with NiMH batteries in a discharged state. Be sure to recharge the batteries prior to the next time the system is used.**

If the batteries are repeatedly recharged in a slightly discharged state, the memory effect of the NiMH battery may considerably reduce the capacity. A reduction in operating time will occur even when the batteries are charged for the recommended time. (After discharge to 1cell E.V.=1 V)

ⓘ **When a LiFe/LiPo battery pack will not be used for a long time, to prevent it from deteriorating we recommend that it be kept in about the half capacity state instead of fully charged. Also be careful that the battery does not enter the over-discharged state due to self-discharge. Periodically (about every 3 months) charge the battery.**

⚠ Warning

⊘ **Do not store your R/C system in the following places.**

- Where it is extremely hot or cold. [Storage temperature range -10°C to +40°C]
- Where the system will be exposed to direct sunlight.
- Where the humidity is high.
- Where vibration is prevalent.
- Where dust is prevalent.
- Where the system would be exposed to steam and condensation.

Storing your R/C system under adverse conditions could cause deformation and numerous problems with operation.

ⓘ **If the system will not be used for a long period of time, remove the batteries from the transmitter and model and store in a cool, dry place.**

If the batteries are left in the transmitter, electrolyte may leak and damage the transmitter. This applies to the model also. Remove the batteries from it also to prevent damage.

<NiMH Battery Electrolyte>

The electrolyte in NiMH batteries is a strong alkali. Should you get even the smallest amount of the electrolyte in your eyes, DO NOT RUB. Wash immediately with water, and seek medical attention at once. The electrolyte can cause blindness. If electrolyte comes in contact with your skin or clothes, wash with water immediately.

<Battery Recycling>

A used battery is a valuable resource. Insulate the battery terminals and dispose of the battery by taking it to a battery recycling center.

Other Precautions

⚠ Caution

⊘ **Do not expose plastic parts to fuel, motor spray, waste oil or exhaust.**

The fuel, motor spray, waste oil and exhaust will penetrate and damage the plastic.

ⓘ **Always use only genuine Futaba transmitters, receivers, servos, ESCs (electronic speed controller), Batteries and other optional accessories.**

Futaba will not be responsible for problems caused by the use of other than genuine Futaba parts. Use the parts specified in the instruction manual and catalog.

Features

-Full color screen LCD

T6PV has a 3.2 inch, full-color, backlit LCD screen.

-F-4G system & telemetry

Equipped with an F-4G system that enables telemetry with faster response than the T-FHSS SR system.

-UR(Ultra response) mode

Equipped with UR mode that provides even better response than the SR mode. UR servo is required to use UR mode.

-6 channels

Up to 6 channels can be operated by using the S.BUS2 system together.

-MINI-Z system

By setting to the MINI-Z system in the receiver setting menu, you can use Kyosho MINI-Z. Compatible MINI-Zs vary depending on the system.

-Updateable software

Software can be updated by microSD card. Model data can also be saved in a microSD card.

-Model memory for 40 models

Model names can use up to 15 letters, numbers, and symbols, so that logical names may be used. A model memory with different setups can be created by using the model copy function.

-LiFe/LiPo battery can be used

The optional LiFe/ LiPo battery can be used as the transmitter power supply. The running time is extended.

-Response adjustment

If the response is too quick, can mild it.

-Model type

Change the initial settings to suit three types: normal, 1/5 big car, and drift.

-Brake mixing for large cars

Brake mixing of the front and rear wheels of 1/5GP and other large cars can be adjusted independently.

-Steering mixing

Smooth cornering is possible by the independent left and right steering servo setting.

-4WS mixing for crawlers and other 4WS type

This function can be used with crawlers and other 4-wheel steering type vehicles.

-Dual ESCs mixing for crawlers

ESC at the front and rear are controlled independently.

-Gyro mixing

The sensitivity of Futaba car rate gyros can be adjusted from the T6PV.

-CPS mixing

LED lighting and flashing control using our CPS-1 channel power switch can be matched to steering and throttle operation by switch only.

-Tank mixing

This function is intended for vehicles such as tanks.

-Winch mixing

Winch mixing uses a winch and applies bidirectional mixing from the throttle to winch and from the winch to throttle so that the rock crawler and winch can operate simultaneously with one input.

-Drag racing

This function can be used in a drag racing situation, where the driver can use the trans-brake to assist in the staging process.

-Updating receiver

When update software is released for the receiver, can update it by inserting the microSD card with the update software copied onto it into the transmitter and connecting the receiver to the transmitter.

-S.BUS servo

This is a special function that allows setting of the parameters of our S.BUS servo whose settings are changed by using PC Link software.

-MC-Link

This is a dedicated function which allows setting of the contents of the Link software which makes possible Futaba electronic speed controller (ESC), MC971CR/ MC970CR. variable frequency and other data changes by PC at the T6PV.

-Gyro-Link

This function allows you to change the parameters of our car gyro wirelessly from the T6PV main unit. *
Compatible gyro: GYD550 (as of November 2024)

-Throttle speed

Sudden trigger operation on a slippery road surface will only cause the tires to spin and the model to not accelerate smoothly. By setting the throttle speed function, operation can be performed smoothly and easily. It also suppresses battery consumption.

-Steering speed

When you sense that the steering servo is too fast, etc., the servo operating speed (direction that suppresses the maximum speed) can be adjusted.

-Dial select function

This function assigns functions to dials. The step amount and operating direction can also be adjusted. Trim positioning at each model call is unnecessary because all the dials are digital.

-Switch select function

This function assigns functions to 3 switches. The operating direction can also be set.

-Wheel & Trigger position can be changed

The wheel position can be offset by using an accessory APA wheel position offset adapter.

The wheel angle can also be adjusted.

The position of the throttle trigger can be moved forward and backward.

-Trim/dial lock functions

Lock functions which prohibit setting and operation by transmitter trim, and dials are provided.

-Function icon display

Each function is displayed as an easy-to-see icon.

Set Contents

After opening the box, first check if the contents conform to the following. The contents depend on the set as shown below.

Transmitter / Receiver	<p>T6PV / R404SBS or R404SBS-E</p> <p>* Some sets do not include a receiver/servo. The contents of the set vary depending on the order.</p>
Miscellaneous	<p>Wheel offset adapter-M size(APA)</p> <p>APA Mounting screws *Spare screws are also included</p> <p>Wheel adapter 32 deg</p> <p>Brake lever L</p> <p>Wheel Angle spacer 5 deg</p> <p>Large diameter steering wheel</p> <p>UR/SR label</p> <p>Short manual</p> <p>Hex wrench</p>

- If any of the set contents are missing, or you have any questions, please contact your dealer.

 **The R404SBS-E receiver is for electric. Do not use for the gas powered models.**

! Always use only genuine Futaba transmitters, receivers, servos, ESCs (electronic speed controls), batteries and other optional accessories.

Futaba will not be responsible for problems caused by the use of other than Futaba genuine parts. Use the parts specified in the instruction manual and catalog.

In addition, the Fail-safe Unit cannot be used because the system is different. Use the fail-safe function of the transmitter.

Specifications

Transmitter T6PV

*Specifications and ratings are subject to change without prior notice.

- Wheel system, 6 channels (F-4G System), 6 channels (S-FHSS System), 4 channels (T-FHSS systems)
- Transmitting frequencies 2.4GHz band /- Transmitting RF power output: 100 mW EIRP
- Futaba F-4G/T-FHSS/S-FHSS/MINI-Z EVO/MINI-Z EVO2/MINI-Z FHSS systems
- Transmitting antenna 1/2λdipole
- 3.2 inch backlight color display.

Receiver R404SBS / R404SBS-E

- Receiving frequency: 2.4GHz band /- Telemetry Receiver RF power output: R404SBS: 1.02 mW EIRP R404SBS-E: 2.2 mW EIRP
- Power requirement: 3.7 V~7.4 V battery (Dry cell battery cannot be used.)
- System: F-4G system/S.BUS2 system
- Size: R404SBS---1.00x0.81x0.42" 25.5x20.7x10.6 mm
R404SBS-E---1.00x0.81x0.42"(include antenna 1.20") 25.5x20.7x10.6 mm(include antenna 30.5 mm)
- Weight : R404SBS---0.2 oz. (5.7 g) / R404SBS-E---0.25 oz. (7.2 g)

Transmitter T6PV

Transmitter overview

*The switches, dial, and trimmers in the figure are shown in the initial setting position.

*Please be careful not to push the switch too strongly.

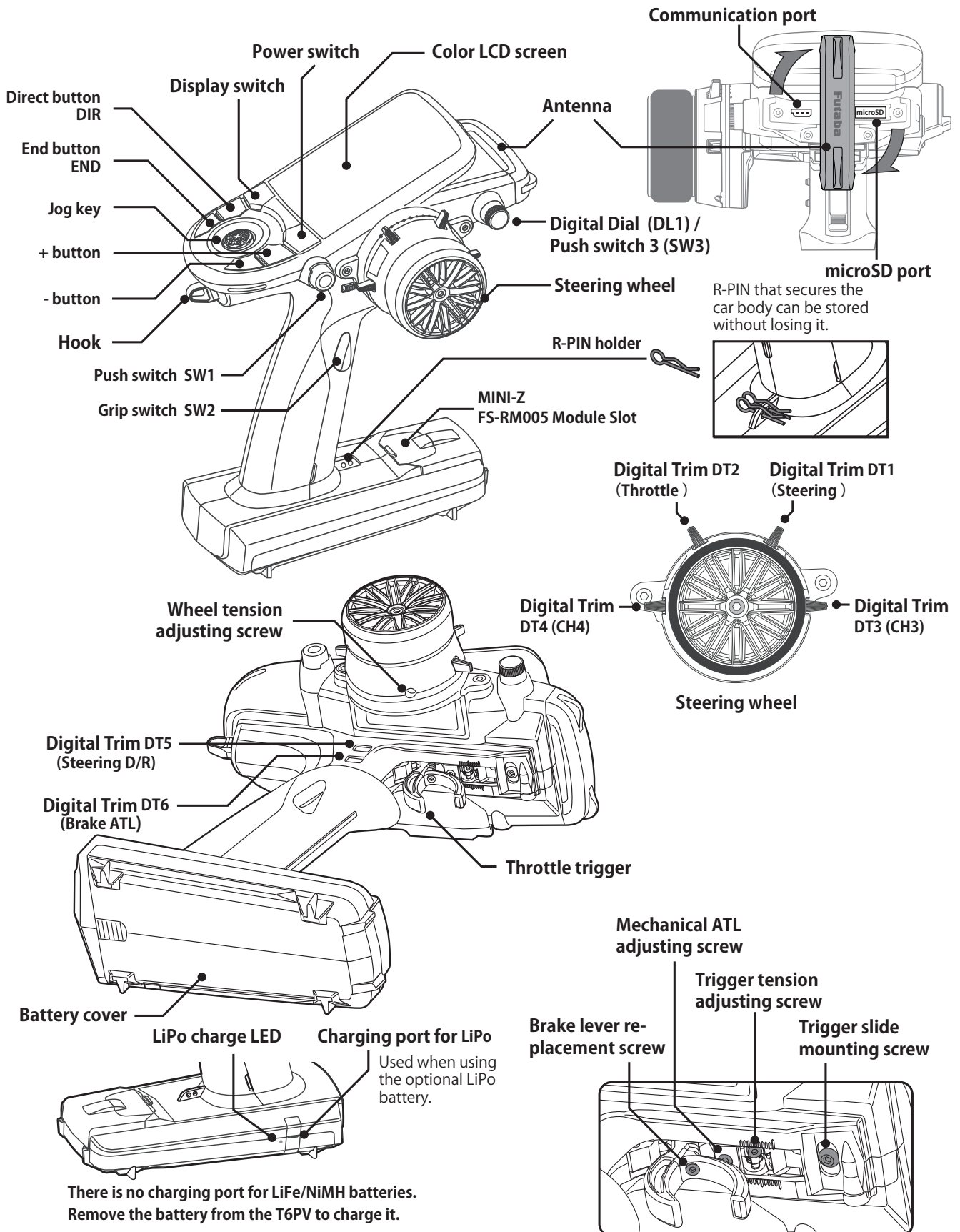

Power & Display Switch

The power switch and display switch are push switches.

When the power switch (PWR) is held down, operation starts by transmitting radio waves. When the display switch (DSP) is held down, the transmitter side data can be checked and set. When the power is turned off, if the power switch or display switch is held down, the power is turned off. If both switches are pressed simultaneously, the power is turned off quickly.

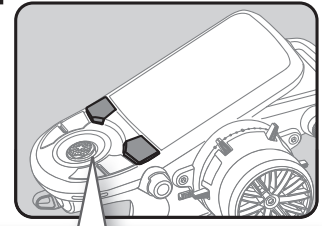

Power & Display Switch

DSP

"Display mode" is shown.

Radio waves are not being transmitted.

It cannot operate.

OFF

When the power is turned off, if the power switch or display switch is held down, the power is turned off. If both switches are pressed simultaneously, the power is turned off quickly.

Please turn off if not in use.

PWR

Radio waves are being transmitted.

It can operate.

Display When Power Switch Is Turned On

The current system is shown. When turned on by DSP switch, "Display" is indicated.

Model name (15 characters)

Trim/dial lock display mark

microSD card mark

Upper: Steering trim display

Lower: Throttle trim display

ST Trim

TH Trim

Trim / Dial

DT1 Steering trim 0

DT2 Throttle trim 0

DT3 Channel 3 control +0

DT4 Channel 4 control +0

DT5 Dual rate +100

DT6 Brake1 rate(ATL) +100

DL1 Off

Total timer

Transmitter Battery voltage display

Receiving signal strength of control signal.

Receiver battery voltage.

Functions and rate assigned to each trims/dials.

*The figure above is partly processed for explanation, so it is different from the actual screen display.

Power Off Forgotten Alarm & Auto Power Off

When leave the transmitter without any operation of steering wheel, throttle trigger, push switch, edit button, or other operation 10 minutes, the audible alarm will sound and the message "Warning: Auto power off" will appear. If any operation given within 5 minutes from the warning the alarm is reset. On the other hand, If the operation is not given in 5 minutes, the power will be automatically shut down. If you want to disable this alarm and the auto power off function, they can be set by System menu--Battery setting. (Refer to country distributor WEB for detailed explanation.)

Low Battery Alarm

If the transmitter battery voltage drops below the usable range, an audible alarm will sound and "Low battery" will appear on the display. Since the usable range of Dry cell battery/NiMH/LiFe and LiPo batteries is different, the battery type using must be set by System menu → Battery. (Refer to country distributor WEB for detailed explanation.)

⚠ Warning

❗ When a low battery alarm is generated, cease operation immediately and retrieve the model. Always replace with a new dry battery before running next.

If the battery goes empty while in operation, you will lose control of the model.

Steering Wheel And Throttle Trigger Operation

(CH1: Steering wheel, CH2: Throttle trigger)

Steering Wheel Function: Turns the model right or left.

Throttle Trigger Function: Controls the speed of the model as well as the direction of travel - forward or reverse.

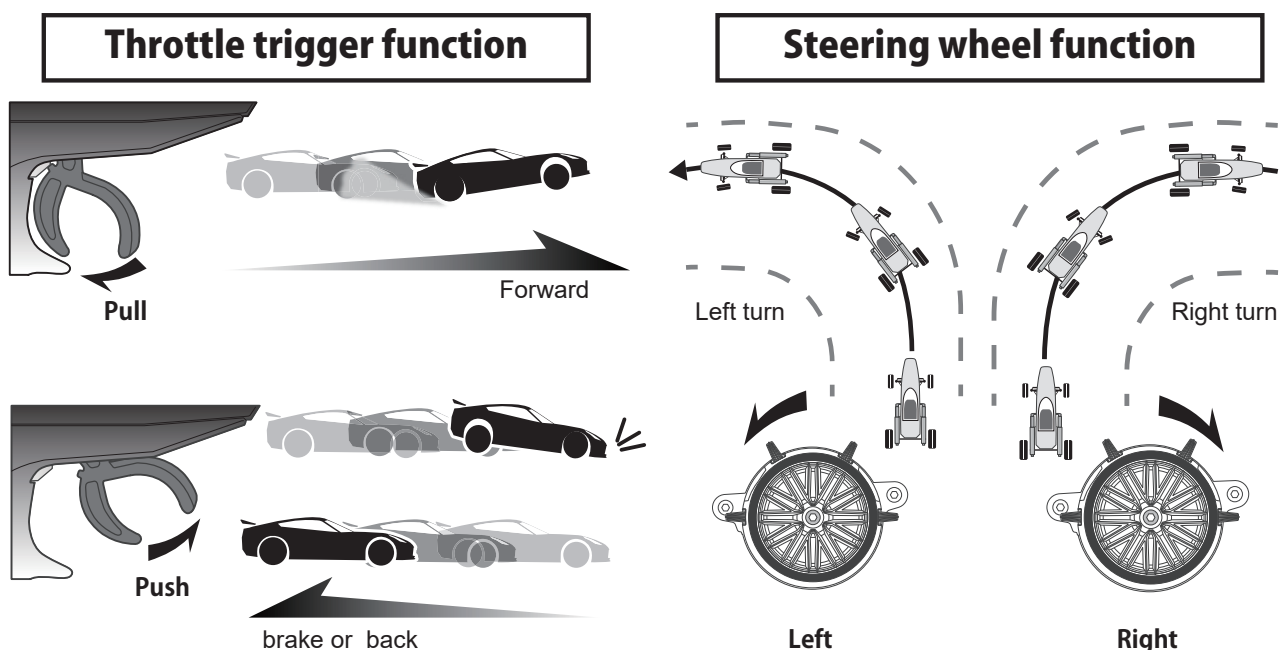

Digital Trim Operation

(Initial settings: DT1: Steering trim, DT2: Throttle trim, DT3: Channel 3, DT4: Channel 4, DT5: Steering D/R, DT6: ATL-Brake rate)

Operating by the trim: Push the trim lever to the left or right (up or down). The current position is displayed on the LCD screen.

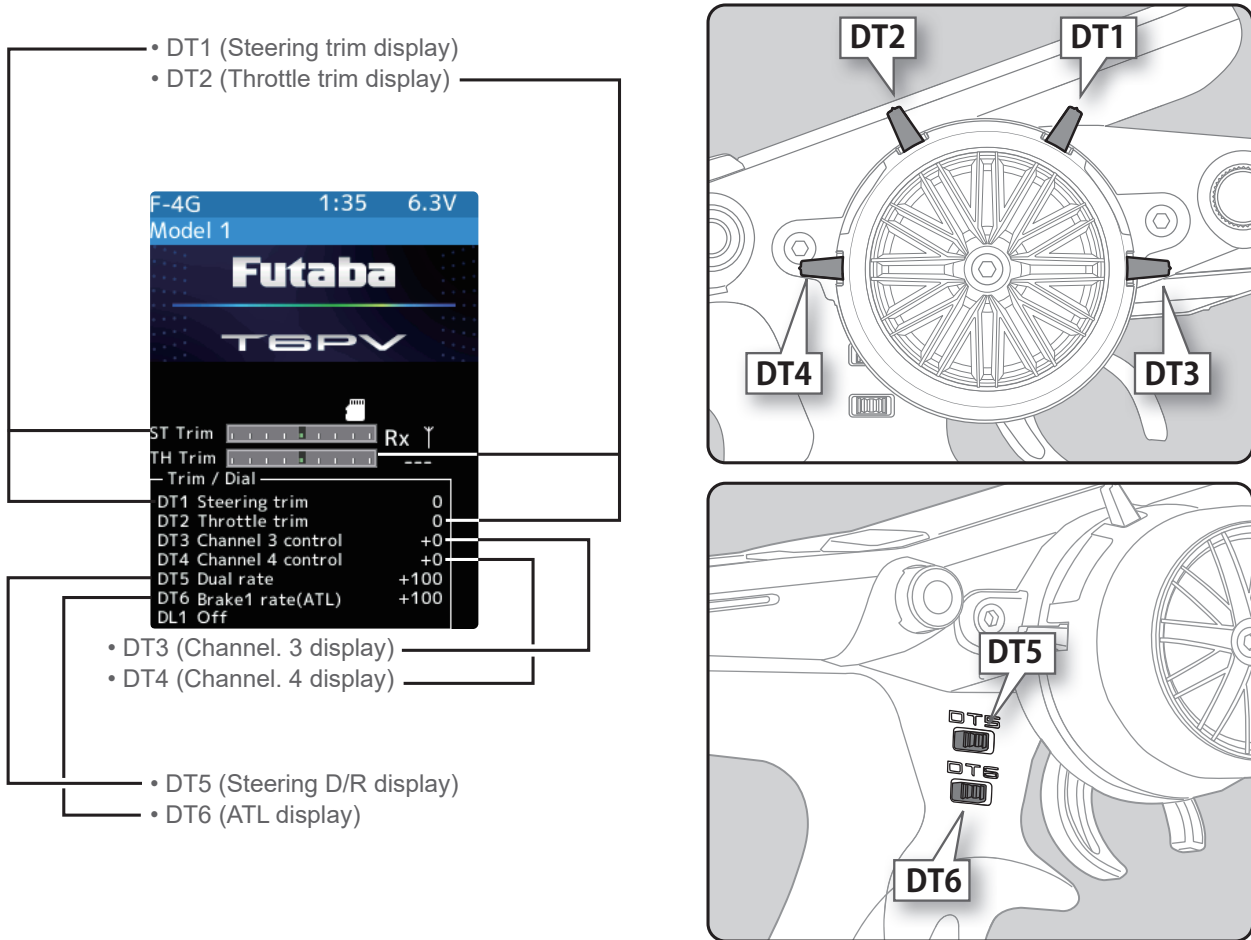

- Each step is indicated by a tone.
- When the trim exceeds the maximum trim adjustment range, the beep will change and the servo will not move any farther.
- When the steering wheel is neutral, adjust the steering trim so that the car goes straight without curving left and right.
- Adjust the throttle trim so that the car stops when the throttle trigger is in neutral so that the brake will not be applied when the throttle trigger is released during operation.
- Steering D/R :The steering left and right servo travels are adjusted simultaneously.
- ATL: Decreases the set value when the braking effect is strong and increases the set value when the braking effect is weak.

Steering And Throttle Trim Operation

With the center trim feature, trim adjustments have no effect on the maximum servo travel. This prevents the linkages from binding when adjustments are made.

Trim/Dial Lock

T6PV setup and operation by digital trim DT1, DT2, DT3, DT4, DT5 and DT6 and dials DL1 can be prohibited.

Setting

- 1 When the END button is pressed for about 1 second on the initial screen, a confirmation beep sounds and the trim/dial lock sign appears on the screen.

Clearing

- 1 Edit button lock and trim/dial lock can be cleared in the initial screen state by the same method as the setting described above. (The trim/dial lock sign disappears from the screen.)

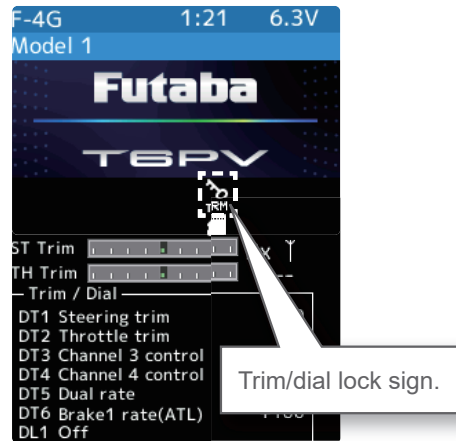

Mechanical ATL Adjustment

Make this adjustment when you want to decrease the stroke of the brake (back) side of the throttle trigger for operation feel.

Adjustment

- 1 Using a hex wrench, adjust the trigger brake (reverse) stroke. (The screw moves the throttle trigger stopper.)
 - Adjust the stroke while watching the screw.

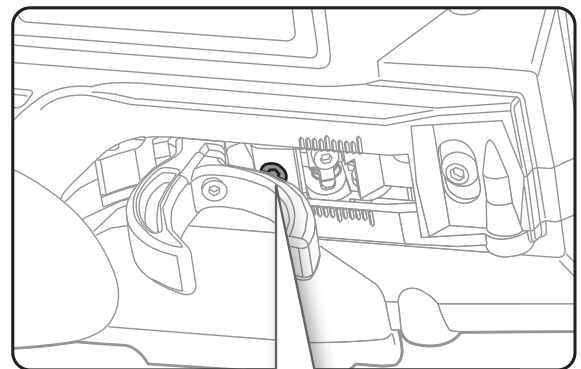

Note:

Once you have changed the mechanical stroke on the brake side, be sure to adjust the scale of the throttle channel accordingly by using the "Calibration Function (System menu)". (Refer to country distributor WEB for detailed explanation.)

Due to this change, you also need to adjust in most cases the travel of the throttle servo.

Wheel & Trigger Tension Adjustment

Make this adjustment when you want to change the wheel or trigger spring's tension.

Adjustment

- 1 Using hex wrench, adjust the wheel spring tension by turning the screw inside the adjusting hole.
 - The spring is set to the weakest tension at the factory.
 - When the adjusting screw is turned clockwise, the spring tension increases.

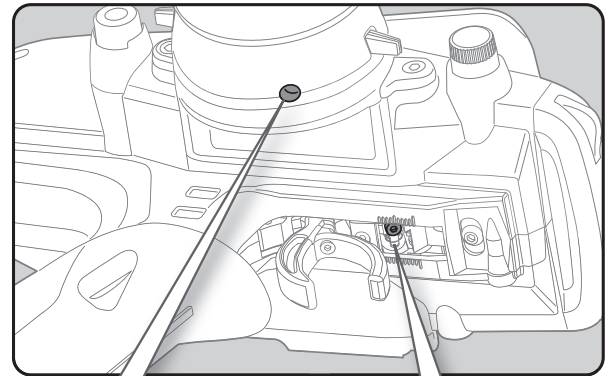

Wheel tension adjusting screw

Trigger tension adjusting screw

Note:

The adjustment range is up to 7 to 8 turns from the fully tightened (strongest) position. If turned farther than this, the adjusting screw may fall out.

Trigger Slide Adjustment

The throttle trigger position can be moved forward and backward.

Adjustment

- 1 Using a hex wrench, loosen the trigger slide mounting screw by turning it slightly counterclockwise.
- 2 Adjust the trigger slide position within the marked range.
- 3 Retighten the mounting screw loosened at step 1 and fasten the trigger slide.

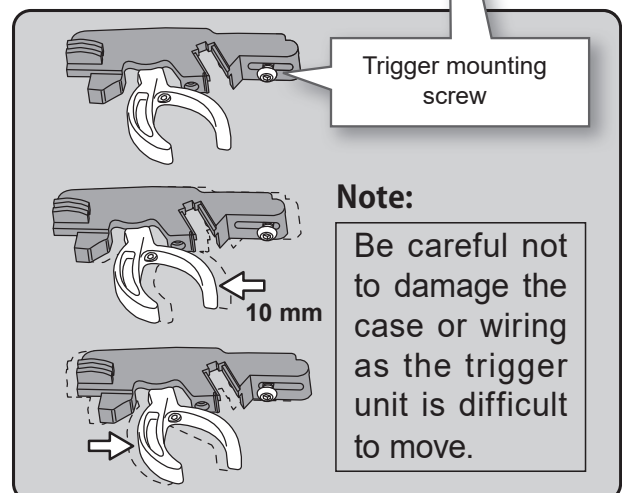
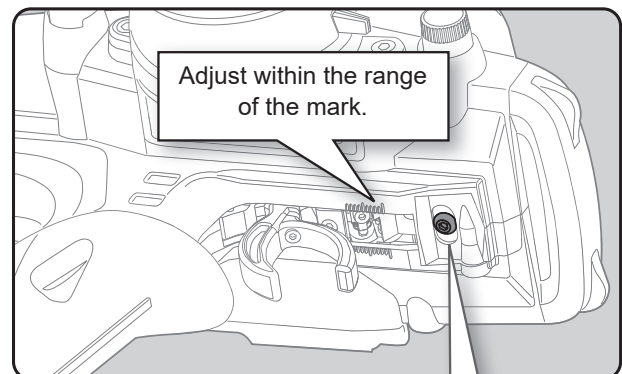

SW: Push switch DL: Dial

The position of various switches. The assignment of each function can be changed for T6PV.

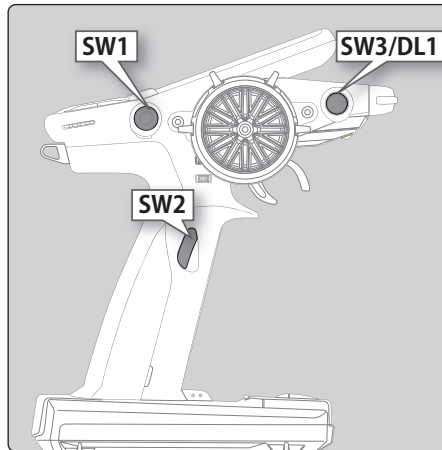

Optional Grip Rubber

Change the thickness of the grip by replacing it with the optional grip rubber for the T10PX.

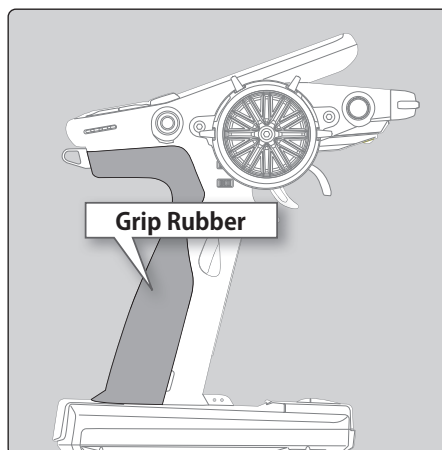

Optional carbon handle

An optional carbon handle (for T10PX) can be installed.

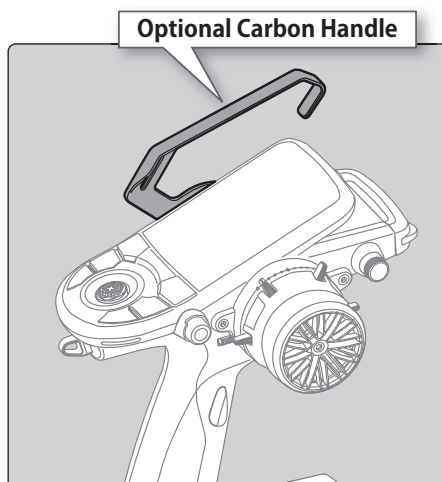

Battery Replacement Method

Load the four batteries in accordance with the polarity markings on the battery holder.

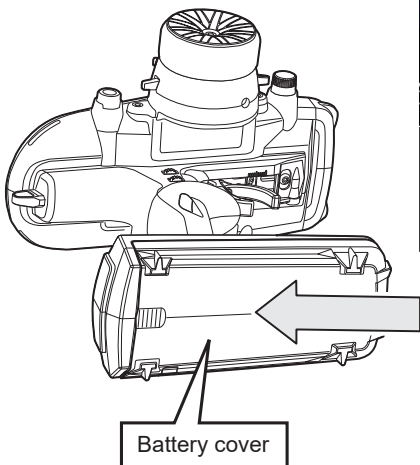
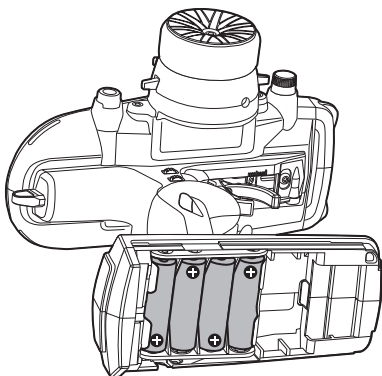
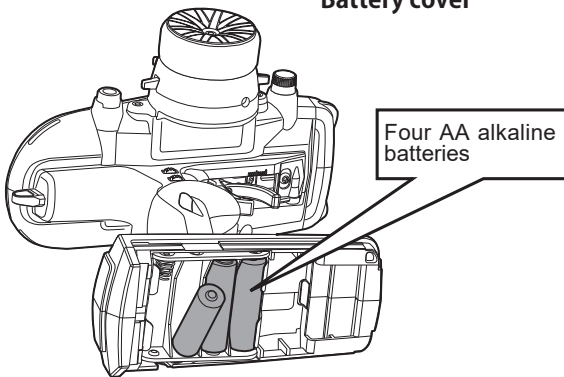
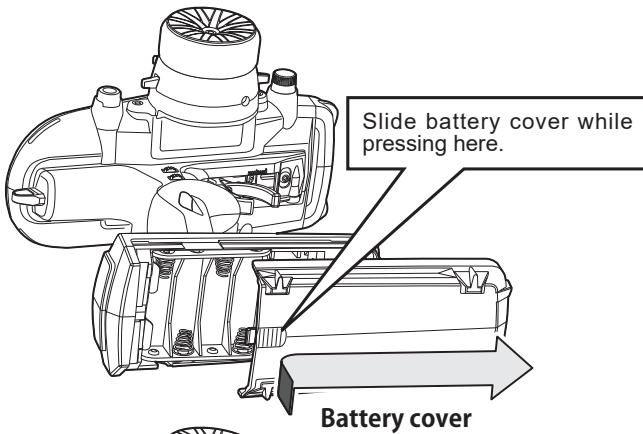

Battery Replacement Method

- 1 Remove the battery cover from the transmitter by sliding it in the direction of the arrow in the figure.
- 2 Remove the used batteries.

⚠ Caution

❗ If you remove the dry cell battery box from the transmitter, replace it carefully with the wiring on the same side as before. Reinstalling the battery box in the opposite direction could cause the wires to be disconnected.

- 3 Load the new AA size batteries. Pay very close attention to the polarity markings and reinsert accordingly.
- 4 Slide the battery cover back onto the case.

Disposal of the Dry Cell Batteries:

The method to dispose of used dry cell batteries depends on the area in which you reside. Dispose of the batteries in accordance with the regulations for your area.

Low Battery Alarm

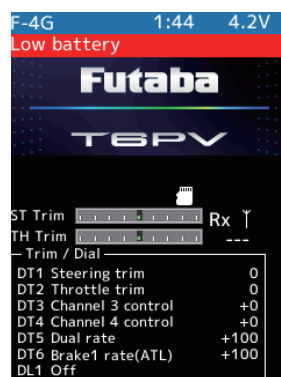

If the transmitter battery voltage drops below the usable range, the audible alarm will sound and "Low battery" will appear on the display. Since the usable range of dry battery/NiMH/LiFe batteries and LiPo batteries is different, the battery type using must be set by system setting. If the battery goes empty while running (cruising), please immediately recover the vehicle (boat) and stop running (cruising) as there is the risk of collision or no way to get the boat back.

⚠ Warning

❗ When a low battery alarm is generated, cease operation immediately and retrieve the model.

If the battery goes empty while operation, you will completely lose the control.

When Using The Optional Battery

- When using an optional rechargeable battery, replace the battery as described below.
- Always use the optional FT2F1100B(V2), FT2F1700B(V2), FT2F2100B, HT5F1800 or LT-2F2000B rechargeable battery.
 - The type of battery used must be selected through the system setting.
 - When the transmitter will not be used for a long time, remove the battery.

NiMH LiFe Battery Replacement Method

1 Remove the transmitter battery cover.

2 After removing the dry cell battery box from the transmitter, disconnect the connector.

⚠ Caution

❗ If you remove the dry cell battery box from the transmitter, replace it carefully with the wiring on the same side as before. Reinstalling the battery box in the opposite direction could cause the wires to be disconnected.

3 Insert the connector of the new battery and load the new battery into the transmitter.

⚠ **Change the battery type, be sure to change the [Battery type] setting.**

Change to a LiFe/NiMH battery, go to [System menu] → [Battery] and change it to [Battery type] → **LiFe 2cells/NiMH 5cells**

⚠ **When charging a LiFe/NiMH battery.**

Be sure to remove the battery from the transmitter, disconnect the connector, and then charge it.

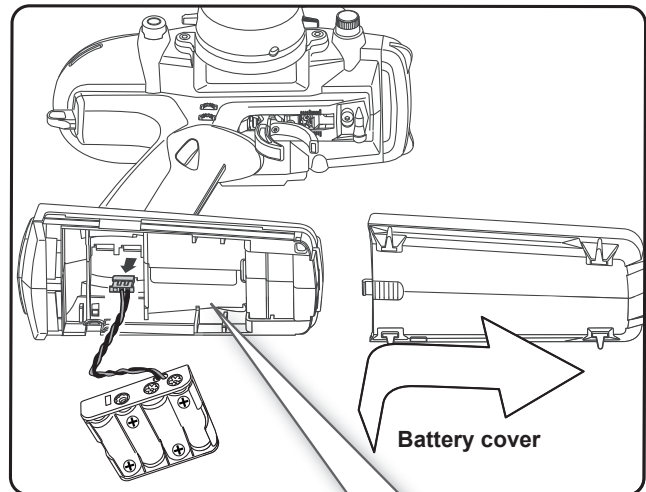

Remove the battery box and disconnect the connector.

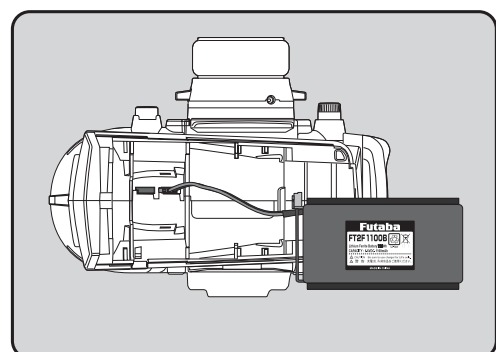
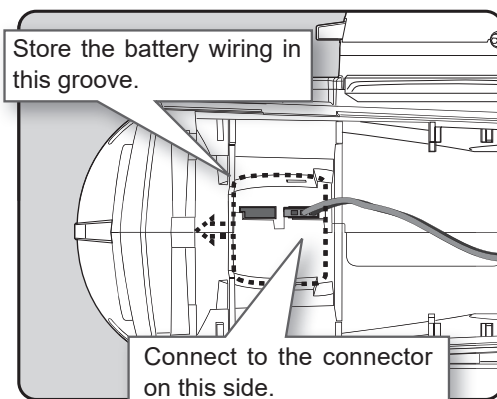
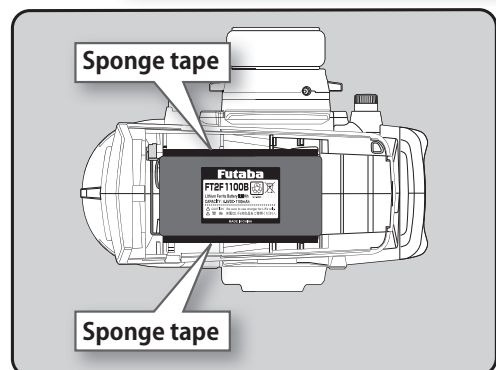

4 Finish by installing the battery cover.

⚠ Caution

❗ **When closing the battery cover, be careful that the battery cover does not pinch the battery lead wires.**
Shorting of the battery lead wires may lead to fire and abnormal heating and cause burns or fire disaster.

LiPo Battery LT2F2000B Replacement Method

When using an optional LiPo battery, replace the battery as described below.

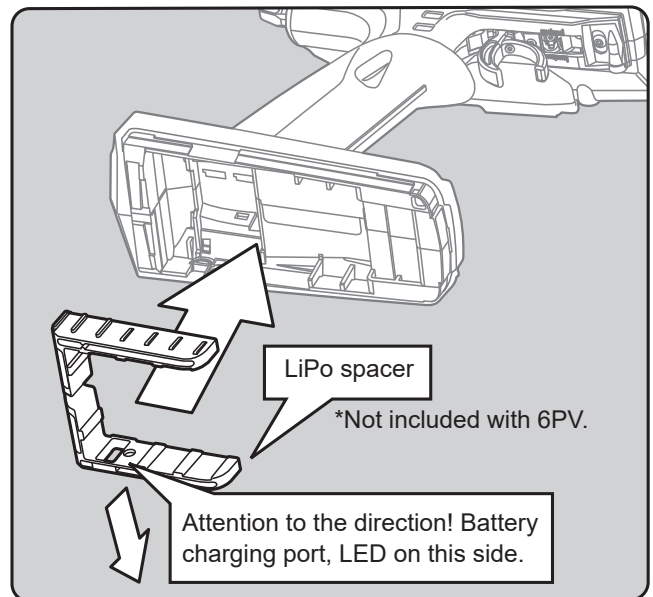
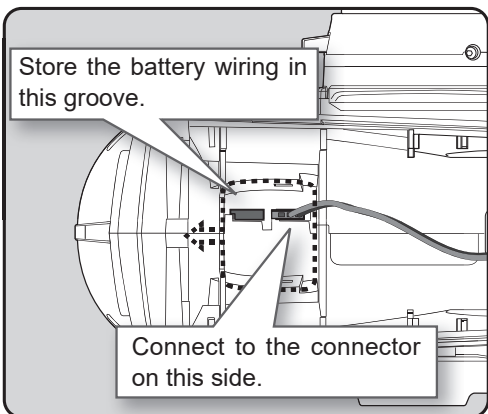
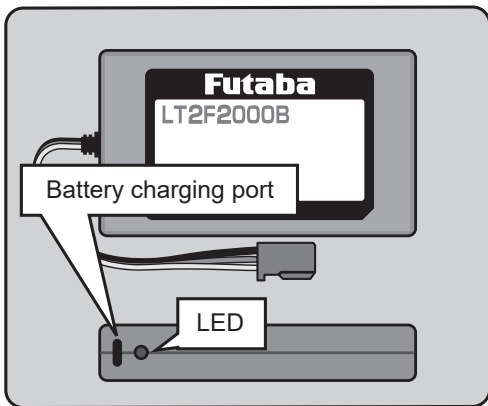

•LiPo battery installation

Install the LiPo spacer on the transmitter and then the LiPo battery.



Change the battery type, be sure to change the [Battery type] setting.

Change to a LiPo battery, go to [System menu] → [Battery] and change it to [Battery type] → **LiPo 2 cells**.

When Charging For The Optional LiPo Battery

To charge the battery, connect a type C USB cable to the Futaba optional USB AC adapter or a commercially available USB AC adapter (USB-A type 5 V-2 A) from the LiPo dedicated charging port.

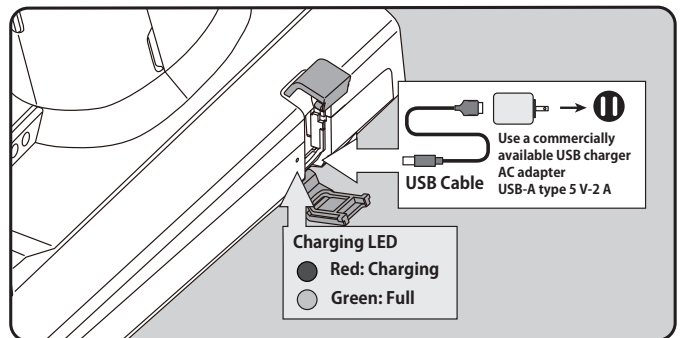
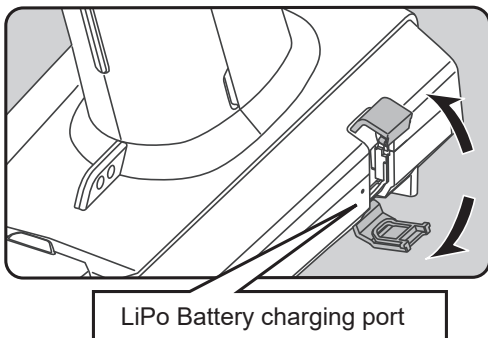

•Charging LED

Lights red while charging. When charging is complete, it lights up in green.

⚠ Warning

⊘ Do not charge the LiPo battery with ICS LF-01.

There is a risk of explosion or fire, which is very dangerous.

⚠ Always charge LiPo batteries with a LiPo battery charger.

Using a different charger, there is a risk of explosion or fire, which is very dangerous.

Steering Wheel Arrangement

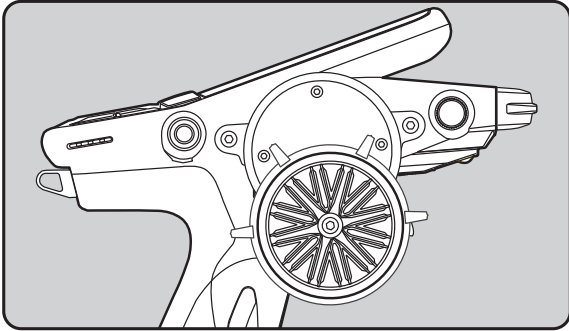

•Changing the wheel position

The wheel position can be offset by using the accessory APA(Adjustable Positioning Adaptor) wheel position offset adapter.

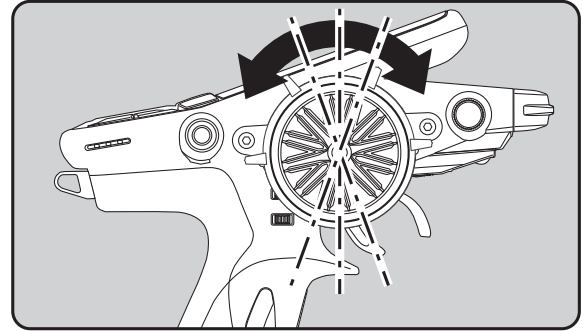

•Angle can be adjusted

The angle can be finely adjusted by adjusting the steering wheel unit installation.
[7.5 ° 48 steps]

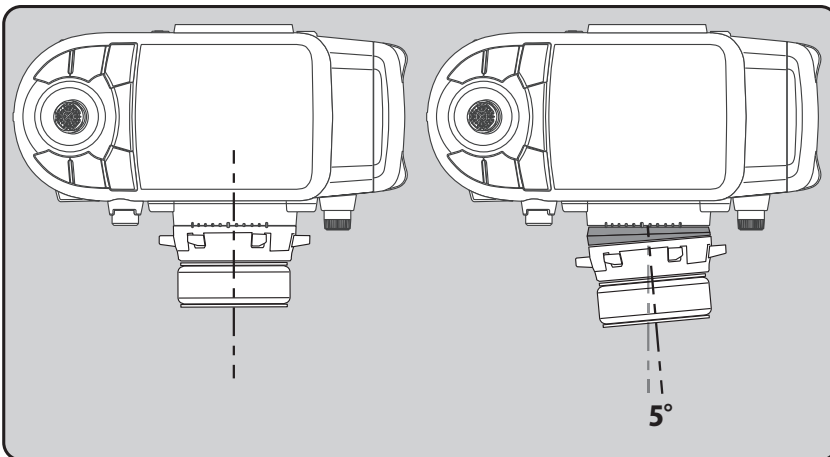

•Angle spacer

The wheel mounting angle can be changed by using the optional angle spacer 5°.

Exchange procedure to wheel adaptor 32 deg and large diameter wheel

The operating angle of the wheel can be adjusted

The operating angle of the wheel can be changed from 34 deg to 32 deg by installing the 32 deg wheel adjuster.

If you install the 32 deg wheel adapter, be sure to adjust the scale of the steering channel accordingly by using the "Calibration Function (System menu)".

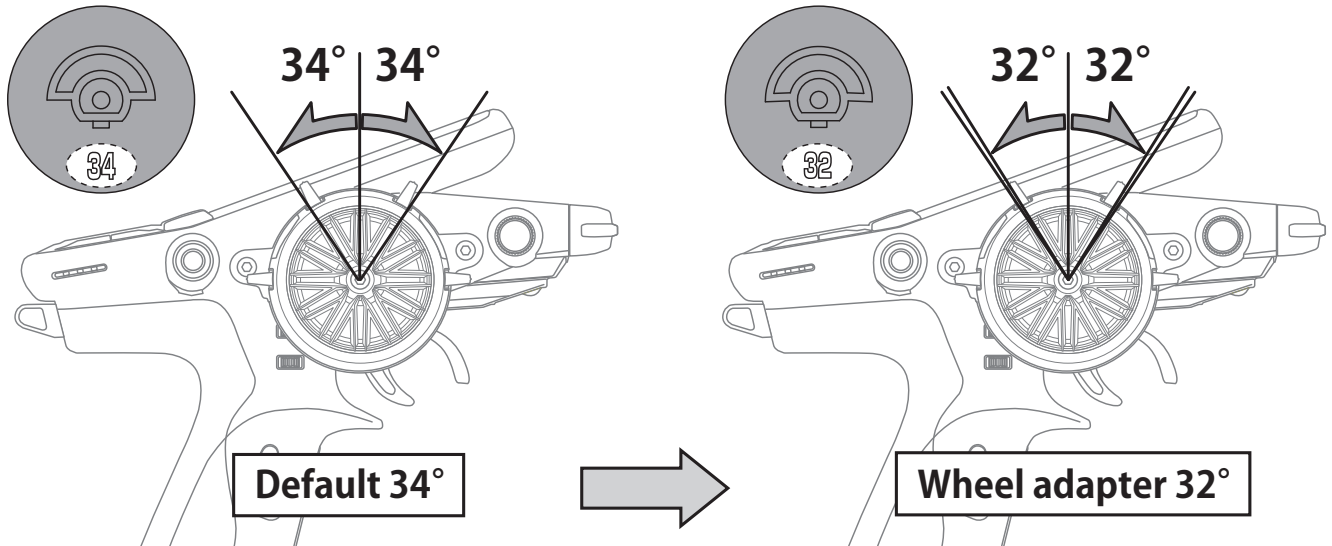

1 Hold the wheel and remove the screw.
(Using a hex wrench.)

2 Pull off the wheel and wheel adapter.

3 Install the standard or large diameter steering wheel and the 32 degree wheel adapter using the screw.
(Using a hex wrench.)

- Adjust the scale of the steering channel accordingly by using the "Calibration Function (System menu)".

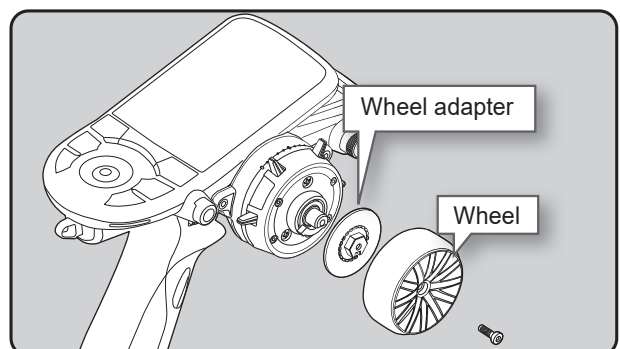
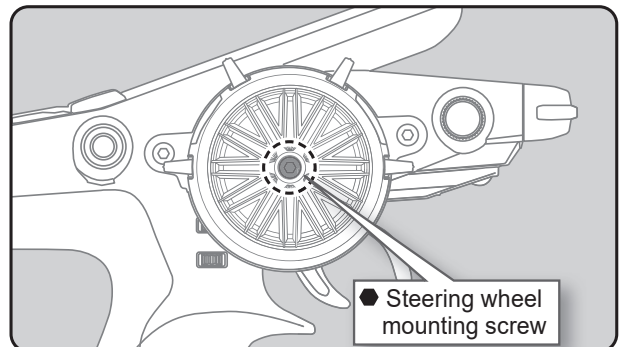

Installing the accessory APA steering wheel offset adapter

- Obtain hex wrench./ Remove the battery.

- 1** Remove the 2 steering unit mounting screws (M3x12 screw).
(Using a hex wrench.)

Remove the 2 mounting screws completely from the transmitter body.

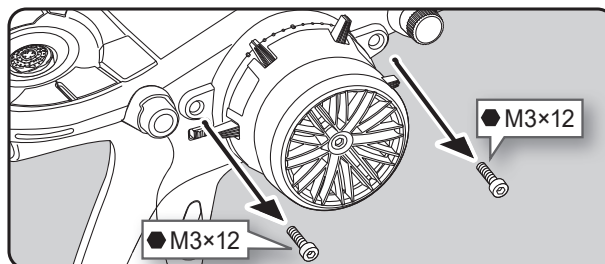

- 2** Gently remove the steering unit, without pulling excessively on the wiring.

- Remove the steering unit slowly so that the internal wiring is not pulled unreasonably.

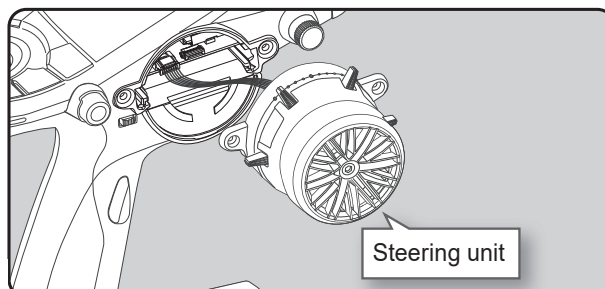

- 3** Remove a connector from the PC board.

Press the upper side of the connector to release the lock and remove it from the PC board.

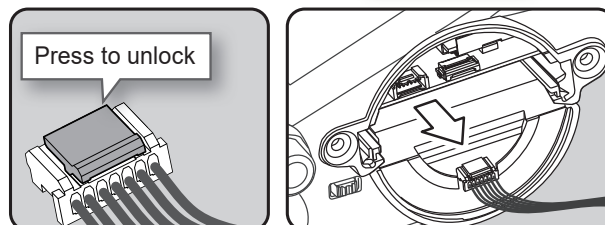

- 4** Hold the wheel and remove the screw.
(Using a hex wrench.)

- 5** Pull off the wheel and wheel adapter.

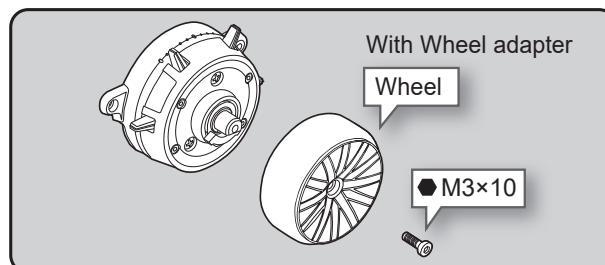

- 6** Using a hex wrench, remove the 4 screws (M2x19) mounting the wheel unit. Remove the wheel unit from the steering housing.

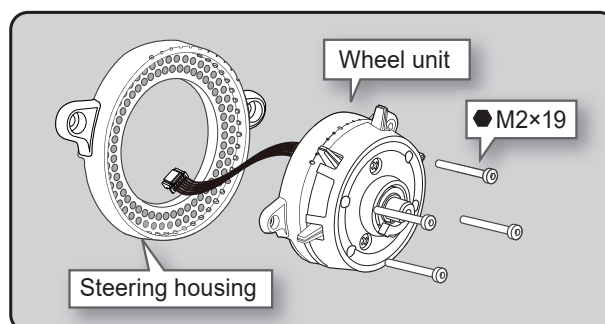

- 7** Pass the wiring from the wheel unit through the hole in the APA parts and steering housing as shown in the figure.

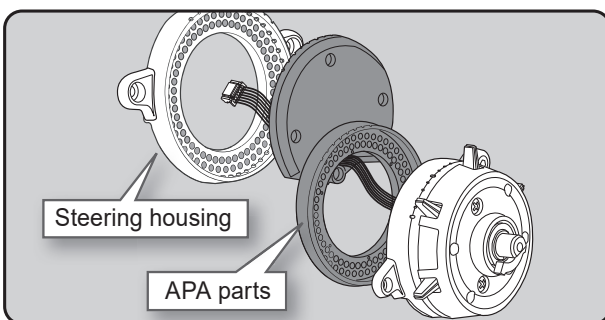
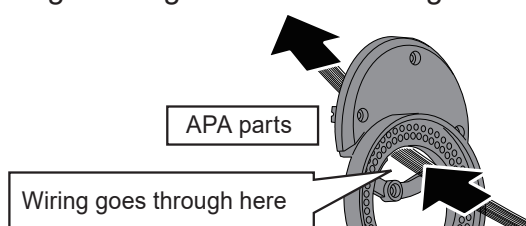

8 Pass the wiring from the wheel unit through the hole in the APA parts and steering housing as shown in the figure.

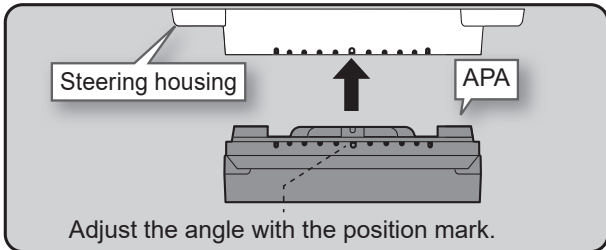
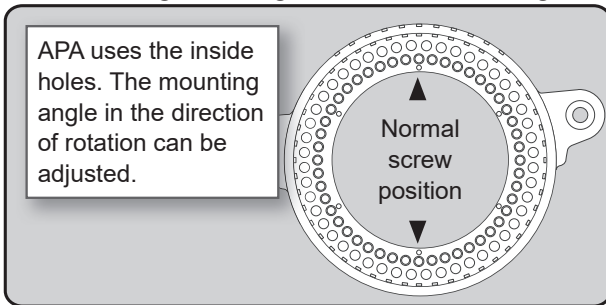

9 Attach the wheel unit to the APA with four M2×19 screws.

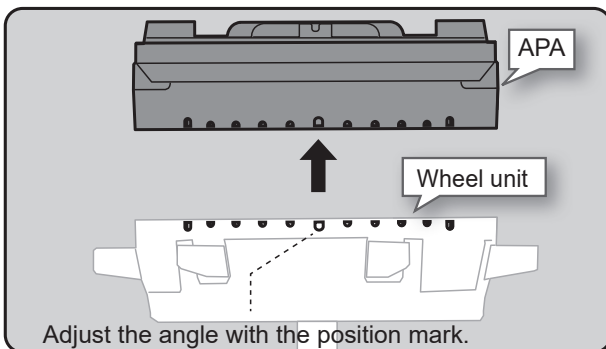

- The angle of the wheel rotation direction can be adjusted.

10 Connect the steering wiring to the transmitter.

- Attention to the connector direction

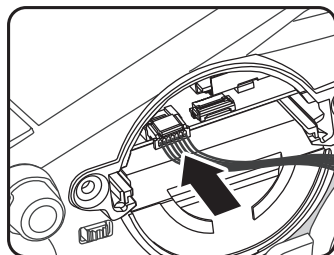

11 Attach the assembled steering unit to the body with two M3x12 screws.
(Using a hex wrench.)

12 Insert the wheel and hold the wheel and attach the screw.
(Using a hex wrench.)

- Install slowly so that the wiring is not pinched.

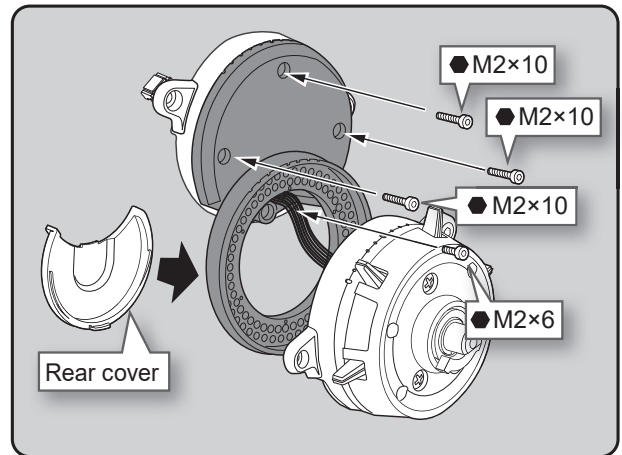

- Use the accessory screws and the transmitter screws.
- There are extra screws in the accessories.

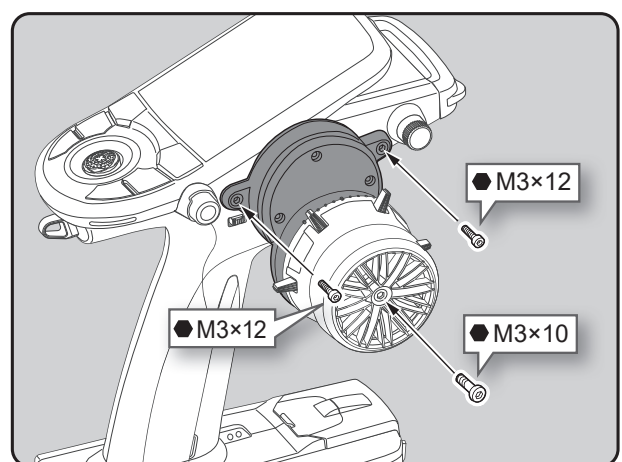
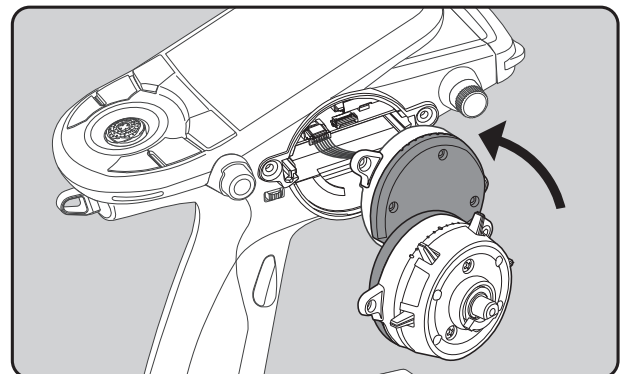
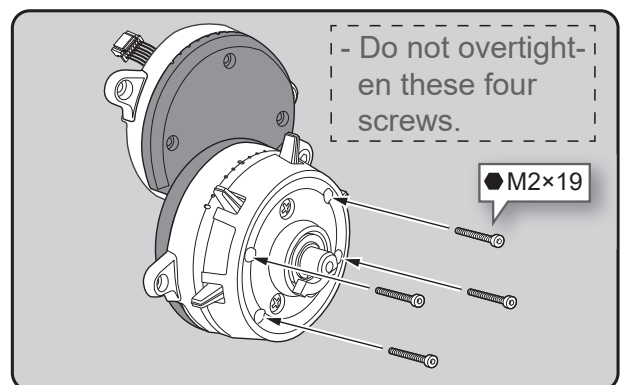

Angle Spacer

The wheel mounting angle can be changed by using the optional angle spacer 5°.

- The angle spacer use the included four M2x5 mm hex screws.
- Obtain hex wrench./ Remove the battery.
- The length of the screws used at each part differs. When reassembling the steering wheel unit, always use the specified screws.

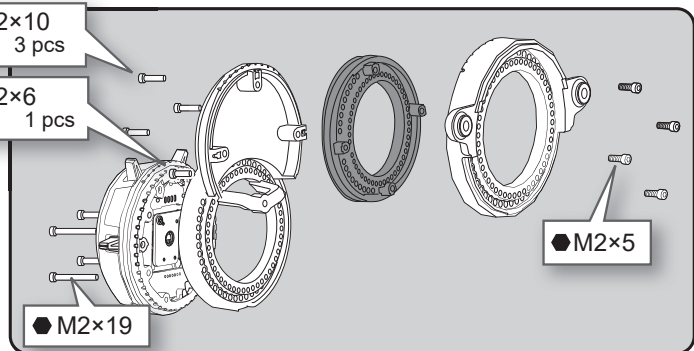
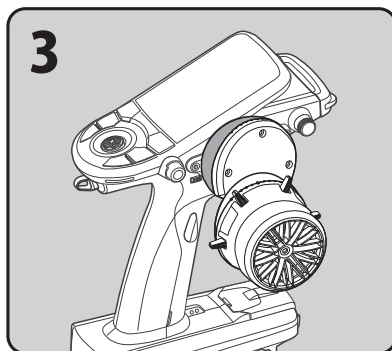
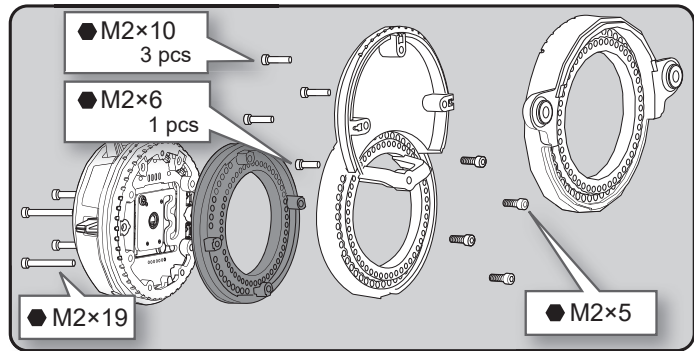
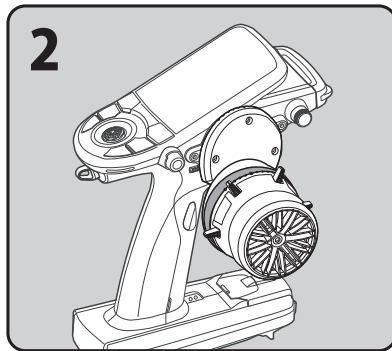
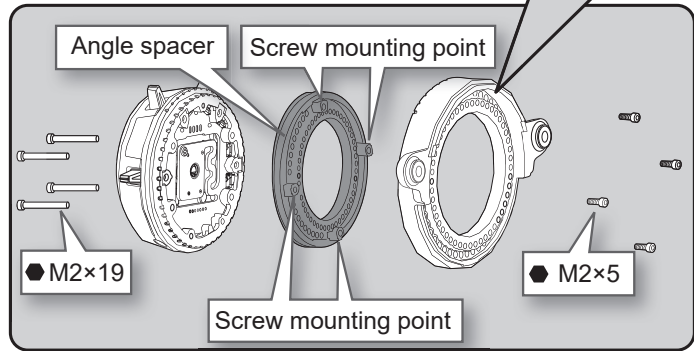
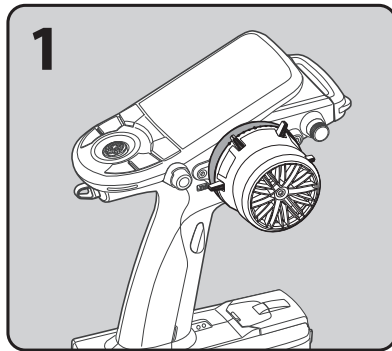
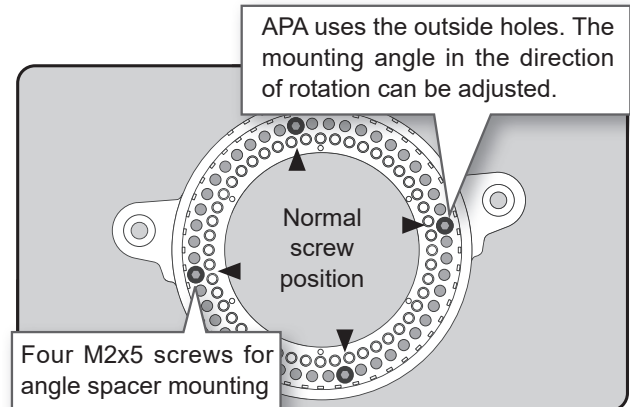
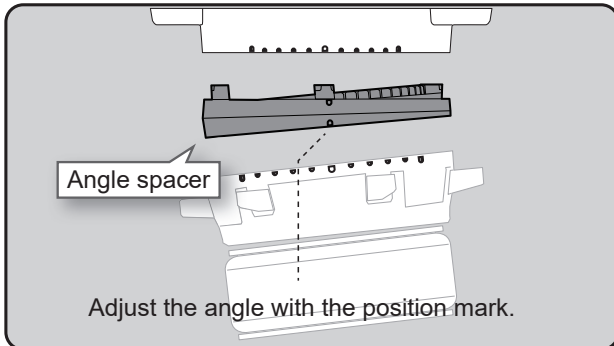

- Use the accessory screws and the transmitter screws.
- There are extra screws in the accessories.
- M2 x 5 screws are special size so be careful not to lose them.
- Do not overtighten M2x19 four screws.

Trigger Brake Lever Replacement

The trigger brake lever can be replaced with the optional trigger brake lever for T10PX / T7PXR / T7PX.

*When the brake lever is changed, perform throttle side correction by adjuster function.

Brake lever replacement

- 1 Hold the trigger, remove the brake lever mounting screw using the hex wrench, and remove the brake lever.
- 2 Using the hex wrench install the brake lever with the brake lever mounting screw.

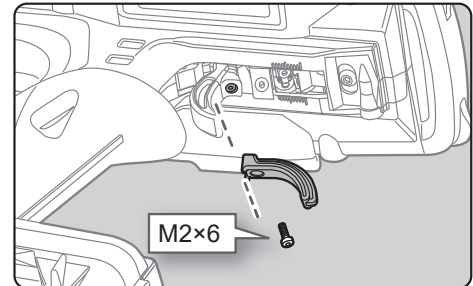

Handling The Antenna

About The Transmitter Antenna

Cannot rotate more than 90°. If rotated forcibly, the antenna will be damaged.

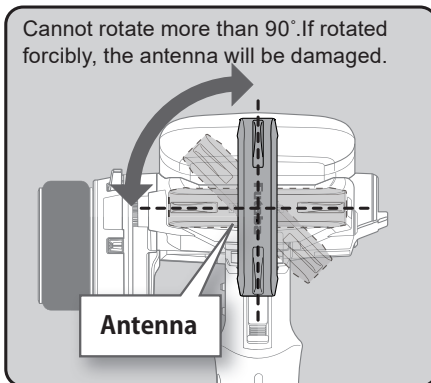

Antenna Moving Range

If the antenna is set to the 45° and 90° vertical position, the range of the radio waves may be greater than in the horizontal position. (Different depending on the conditions)

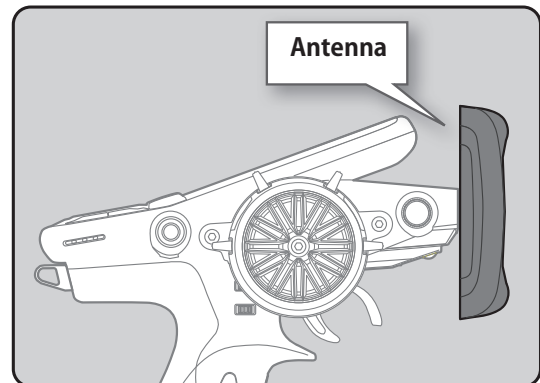

⚠ Caution

- ⊘ Do not grasp the transmitter's antenna while driving.

Doing so may degrade the quality of the RF transmission to the model.

- ⊘ The antenna position can be changed in the direction as shown in figure. However, please do not apply unnecessary force or shock.

The internal cable may be damaged; thus transmitting distance decreases and it may cause malfunction.

There might be a small glitch when the antenna of the transmitter is brought close to servos, ESCs or other peripheral devices.

This is not an issue but please keep this symptom in mind, especially when setting-up.

microSD port

T6PV model data and telemetry log data can be saved by using a commercial microSD card. When T6PV software updates are released, the microSD card can also be used to make the update.

*SD cards other than those conforming to the SD/SDHC standard are not supported.

*Only the FAT file system is supported.

Communication port

Connect compatible devices such as S.BUS servos and perform setup.

Rotating the antenna 90° reveals a microSD port.

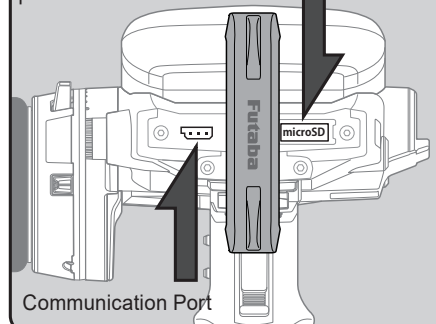

Receiver Terminology

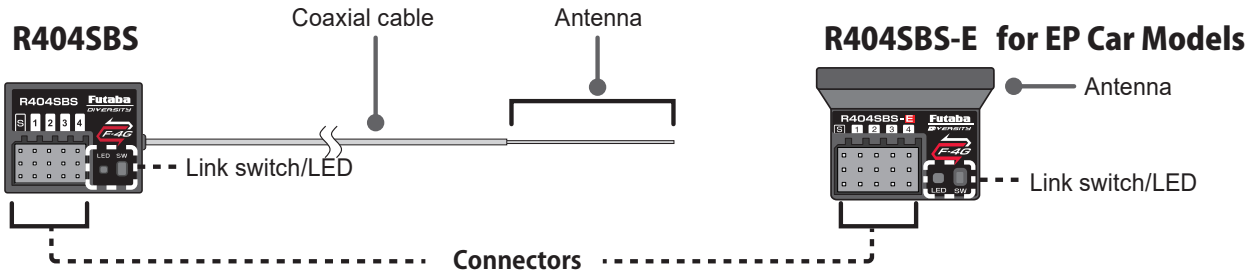

The receiver power supply can be connected to the S.BUS2 connector or each of CH1-4.

- Connectors**
- "4": CH4 servo(CH4)
 - "3": CH3 servo(CH3)
 - "2": Throttle servo/ESC(CH2)
 - "1": Steering servo(CH1)
 - "S": CH5, CH6 S.BUS2 servos
Telemetry sensors

⊘ NEVER use the R404SBS-E in GP(Engine) cars.

Receiver Installation

Install the receiver on the car as follows:

- NOTE:** The operating range may reduced, depending on where the receiver and the antenna are mounted.
- NOTE:** Put the antenna in the antenna tube to protect it. Do not let the tip go outside. (R404SBS)
- NOTE:** It is a receiver of diversity type with both external and internal antennas. Do not place wiring or other objects on the plate. The receiving range may be affected.

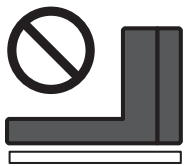

⊘ Do not install the receiver as shown on the left.

⊘ Do not put decals or double-sided tape on the antenna.

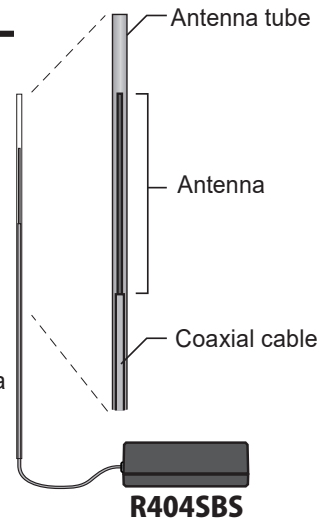

⚠ Warning

- ❗ Install the antenna in the higher place as shown in the figure.
- ⊘ Do not cut or bundle the receiver antenna wire. (R404SBS)
- ⊘ Do not bend the coaxial cable. It causes damage. (R404SBS)
- ⊘ Do not pull the receiver antenna or coaxial cable by force. (R404SBS)
- ❗ Keep the antenna as far away from the motor, ESC and other noise sources as you possibly can.
- ❗ Wrap the receiver with something soft, such as foam rubber, to avoid vibration. If there is a chance of getting wet, put the receiver in a waterproof bag or balloon.

⚠ Caution

❗ Always use R404SBS (-E) under the following conditions:

- Battery :Power requirement Rated voltage 3.7 to 7.4 V (dry cell battery cannot be used)
Matched to the ratings of the receiver and connected servo.
- Transmitter's receiver system > F-4G
- Use the servo that matches the servo type of each receiver response.

Under other conditions, the set will not operate, or the specified performance will not be displayed even if it operates. In addition, it may cause trouble with servos and other equipment. Futaba will not be responsible for damage, etc. caused by combination with the products of other companies.

Receiver And Servo Connections

Connect the receiver and servos as shown below. Connect and install the receiver and servos in accordance with "Installation Safety Precautions" on the next page.

The figure shown below is an example. The method of connecting the electronic speed controller to the motor and battery depends on the motor controller used. Purchase the electronic speed controller and servos separately. The receiver also depends on the set.

Installation when an electronic speed controller is used

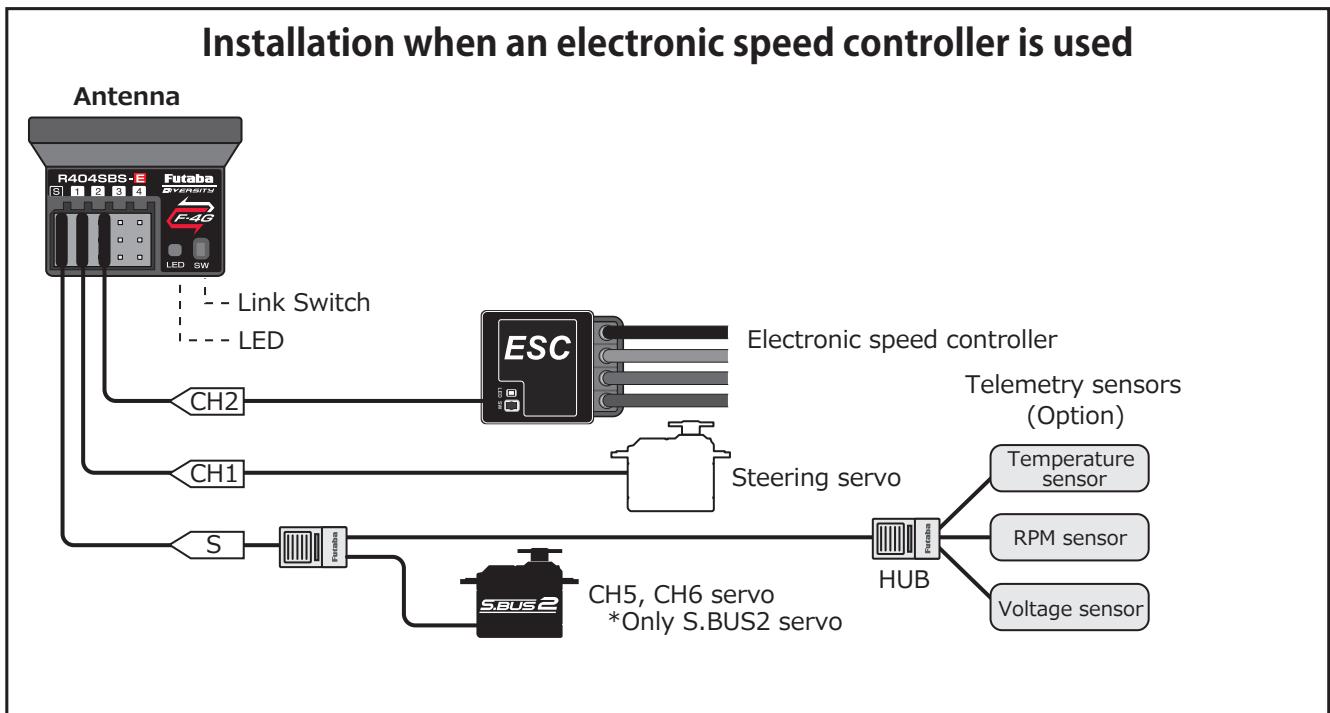

Installation For Gas Powered Models

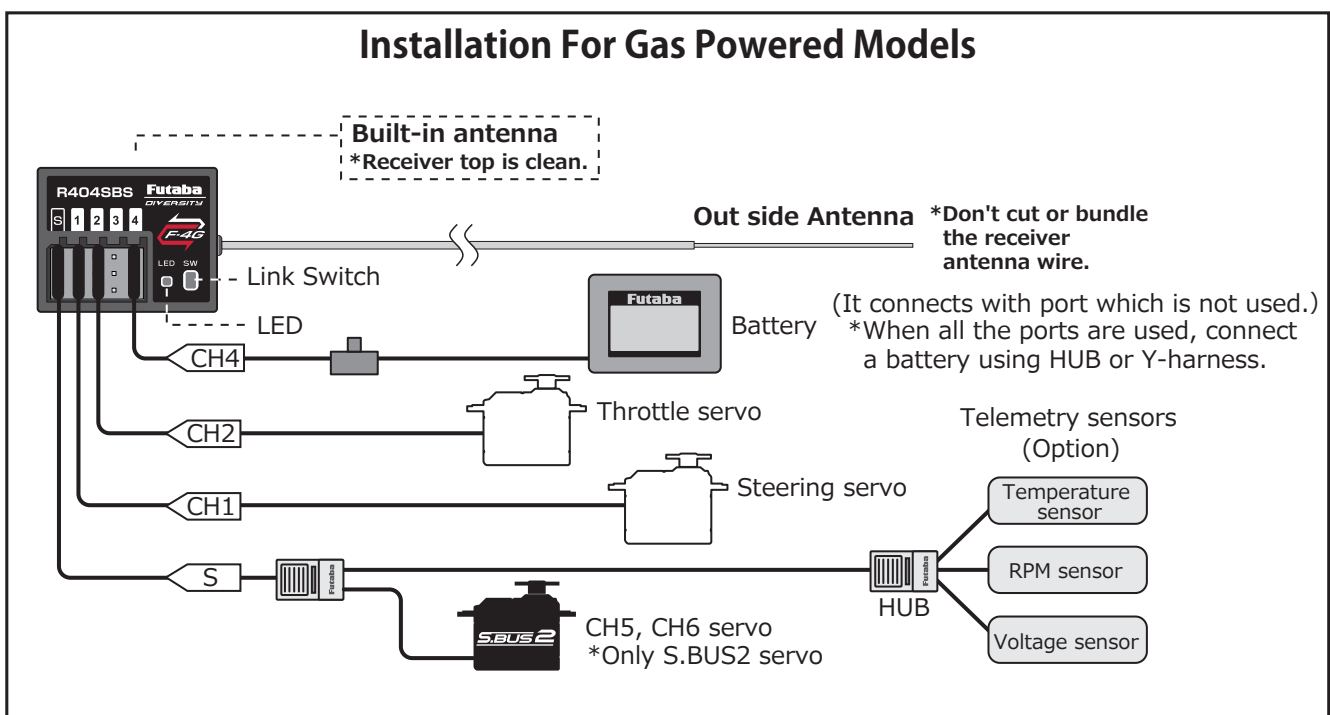

Installation Safety Precautions

⚠ Warning

Receiver (receiver antenna)

- ⊘ Do not cut or bundle the receiver antenna wire. (R404SBS)
- ⊘ Do not bundle the receiver antenna wire together with the ESC lead wire. (R404SBS)
- ⊘ Keep the receiver antenna at least 1 cm away from motor, battery, and other wiring carrying heavy current.
- ⊘ Do not use a metal receiver antenna holder on a plate made of metal, carbon, or other conductive material.
- ⊘ Since the antenna of built-in antenna receivers is installed under this, do not place wiring or other objects on it.

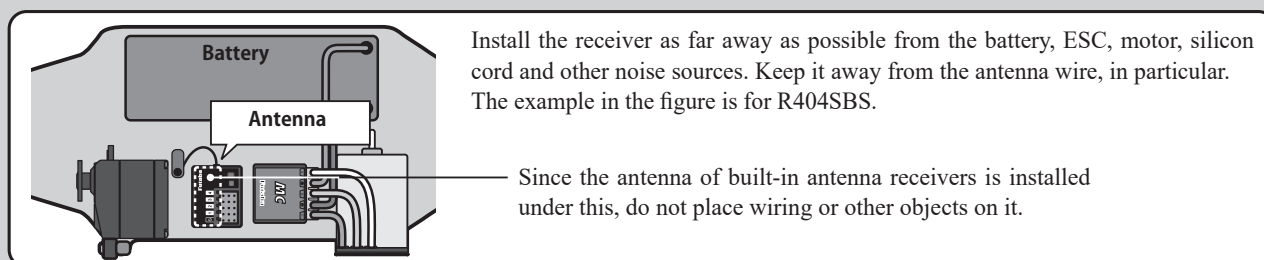

⚠ Warning

Receiver Vibration-proofing / Waterproofing

(Car)

- ❗ Vibration-proof the receiver by wrapping it in foam rubber or other vibration-absorbing material and mount it with thick double-sided tape.
- ❗ When using the receiver holder supplied with the model kit, mount the holder to the chassis through a rubber grommet.

(Boat)

- ❗ Vibration-proof the receiver by wrapping it in foam rubber or other vibration-absorbing material. Also waterproof the receiver by crusing it in a plastic bag.

If the receiver is exposed to strong vibration and shock, or the ingress of water, it may not operate correctly and you may lose control of the model.

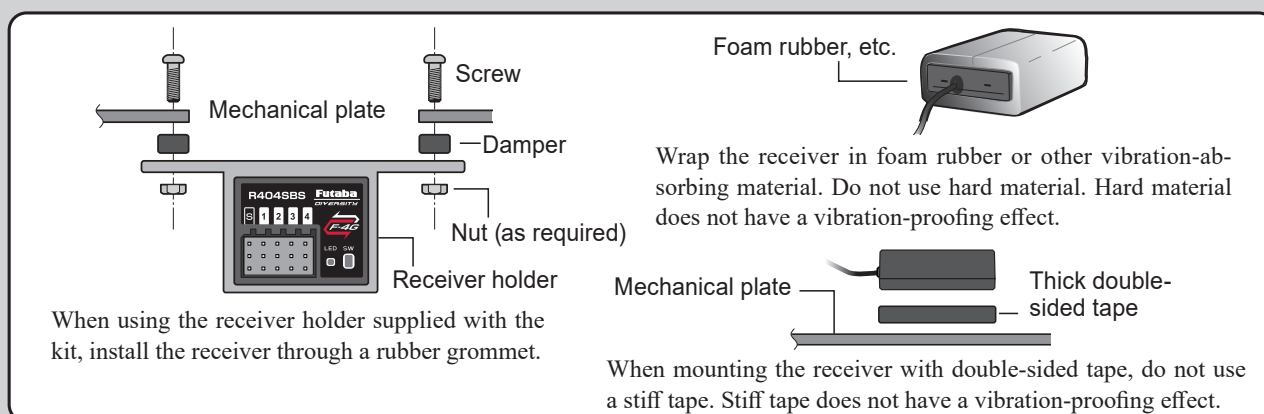

Connector Connections

- ❗ Be sure the receiver, servo, battery and connectors are fully and firmly connected.

If vibration from the model causes a connector to work loose while the model is in operation, you may lose control.

Servo Installation

- ❗ When you install the servos, always use the rubber grommets provided in servo hardware bags. Mount the servos so they do not directly come in contact with the mount.

If the servo case comes in direct contact with the mount, vibration will be directly transmitted to the servo.

If this condition continues for a long time, the servo may be damaged and control will be lost.

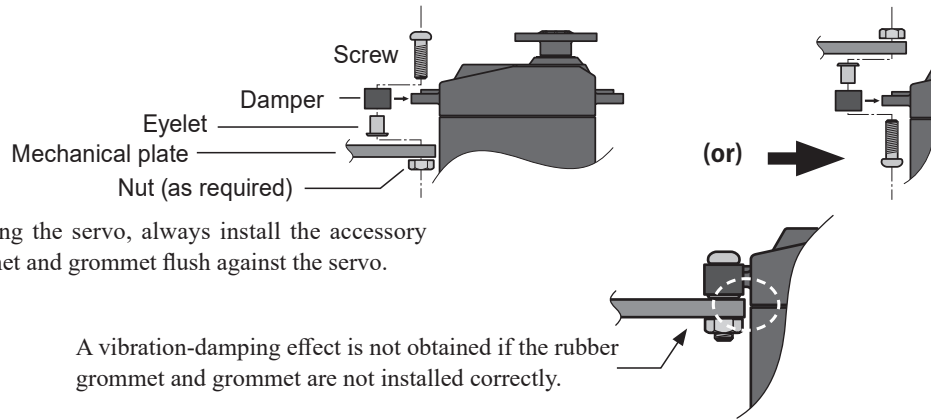

⚠ Warning Servo Throw

- ❗ Operate each servo over its full stroke and be sure the linkage does not bind or come loose.

The continuous application of unreasonable force to a servo may cause damage and excessive battery drain.

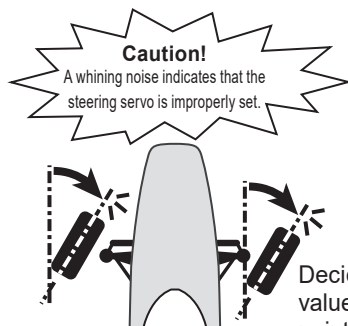

Adjust the steering servo so that unreasonable force is not applied to the servo by the chassis at maximum servo travel.

Decide the End point value at the contact point.

Adjust the throttle servo so that unreasonable force is not applied when the engine carburetor is fully open, fully closed, and the brakes are applied fully.

If the brakes overheat while running, their ability to function properly decreases. Before running, adjust the suitable maximum servo travel so that unreasonable force is not applied even when the servo travel is increased while running.

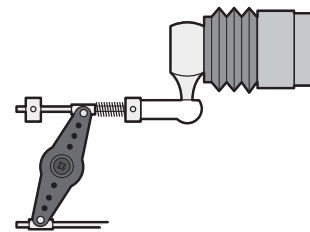

⚠ Warning Electronic Speed Controller

- ❗ Install the heat sinks where they will not come in contact with aluminum, carbon fiber or other parts that conduct electricity.

If the ESC (Electronic speed controller) heat sinks touch other materials that conduct electricity a short circuit could occur. This could result in loss of control and damage to the system.

Motor Noise Suppression

- ❗ Always install capacitors to suppress noise when electric motors are used.

If capacitors are not properly installed you could experience erratic operation and reduced range as well as loss of control.

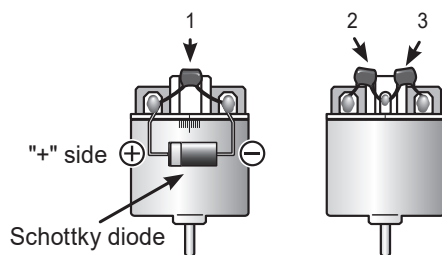

Motors with no suppressor capacitors, or inadequate suppression, may cause the receiver to malfunction. Always solder the capacitors supplied to your motor.

The Schottky diode improves the efficiency of the speed control / motor combination and provides extra protection to the brake FETs. The white ring must always face the positive side.

Other Noise Suppression Methods

- ❗ Be sure there are no metal parts in your model which under vibration can come in contact with other metal parts.

Metal to metal contacts under vibration will emit a high frequency noise that will affect the receiver's performance. You could experience erratic operation and reduced range as well as loss of control.

Menu Selection

This section explains how to operate the basic screens. The jog keys and DIR/END button are used to operate the screens.

*You can return to the home screen from each screen by pressing and holding the END button.



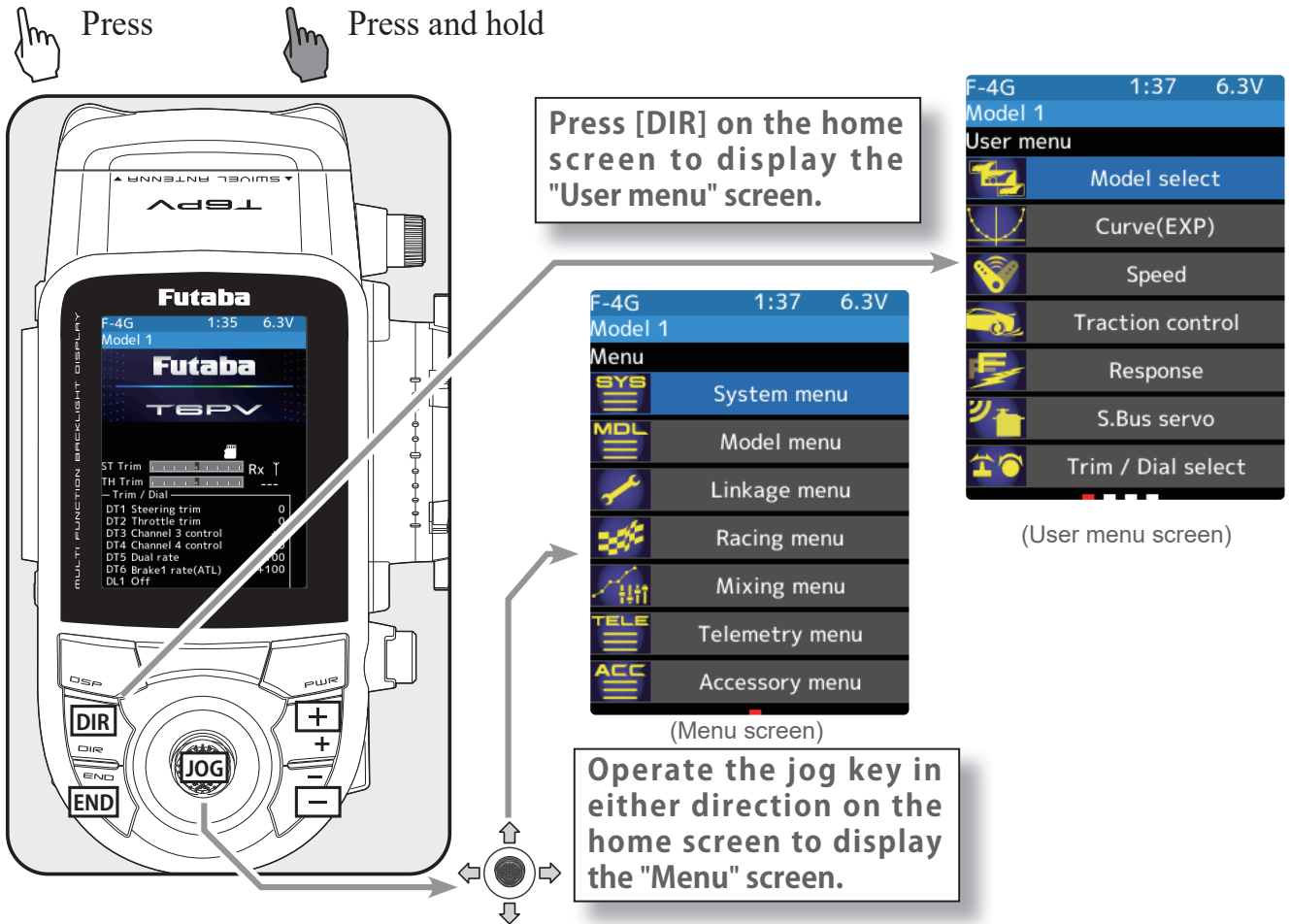

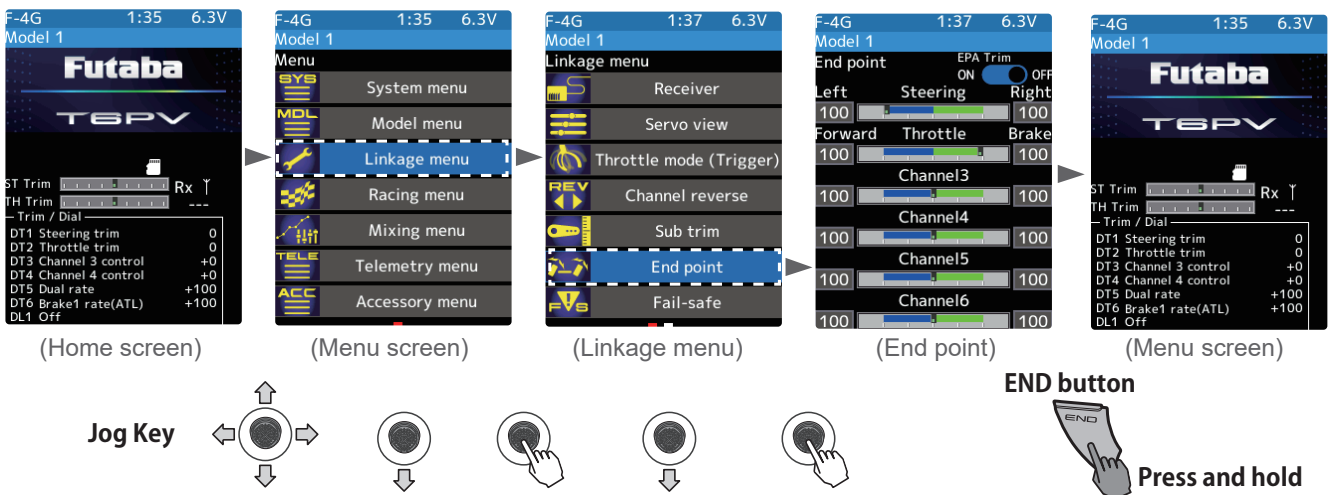

Display Menu Screen

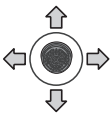

Calling the endpoint screen /Returning from the endpoint screen to the home screen



Jog key/DIR/END Button

- 
 - Move the jog key up, down, left and right to move the cursor. Press the jog key to set the data at the cursor position.
- 
 - If the screen has several pages, move the jog key left or right to move between the pages of the screen.
- 
 - Pressing the END button on the menu screen or any setting screen will return to the previous screen.
- 
 - Press and hold the END button on the menu screen or any setting screen to return to the home screen.
- 
 - Use the ± button to change the value/setting. Pressing the ± button simultaneously will reset the value to the initial value.
- 
 - Press and hold the END button on the home screen to activate the trim lock, disabling operation of the T6PV's main unit's digital trims DT1 to DT6 and dial DL1.
- 
 - Assign your preferred function screen to the DIR/END button and move to it with one touch.

How to assign your desired function screen to DIR/END button.

(Menu screen)



(Accessory menu page 1)



(Accessory menu page 2)

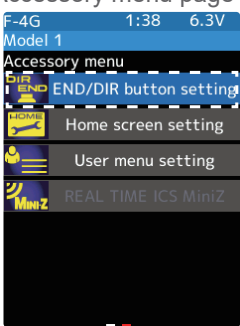

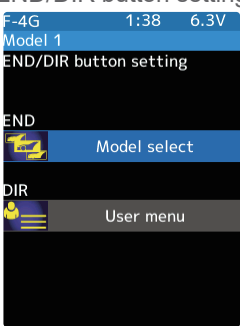

(END/DIR button setting)



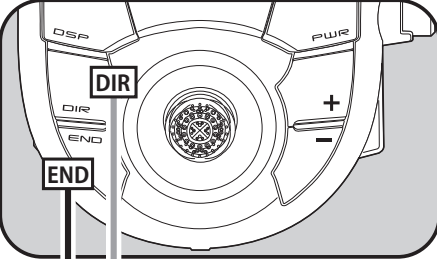

Jog Key 





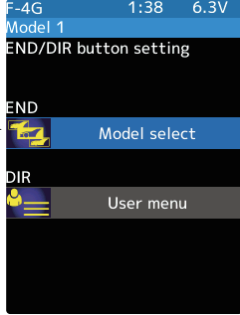
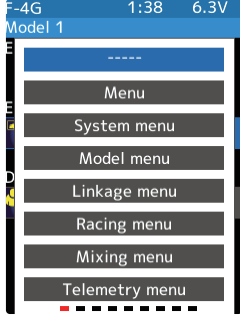







Jog Key 

Select a screen to display by pressing DIR/END button.

You can select the display of a specific function screen. Select from the function list and select it.

Since there are multiple pages, move the jog key the mark and move the page. 

When selection is done, press [END] to escape.

Value Of Each Function And Changing The Set Value

On the setting screen for each function, to increase or decrease the data value, select the item with the jog key and press the [+] or [-] button to set. Pressing the [+] and [-] button simultaneously will return to the initial value.

*The example below shows the endpoint screen.

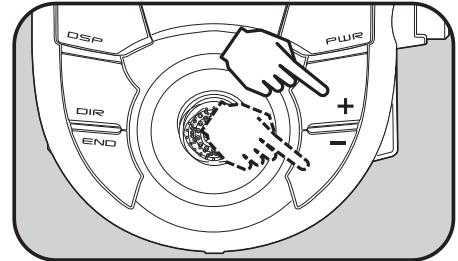
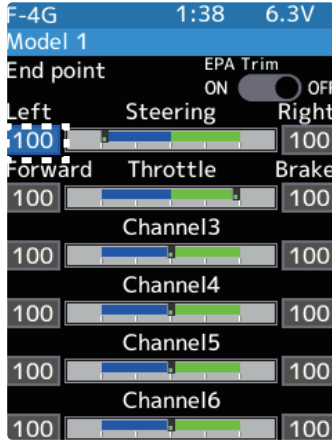
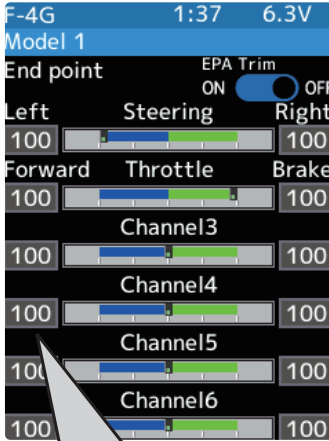

Use +/- button to set the value

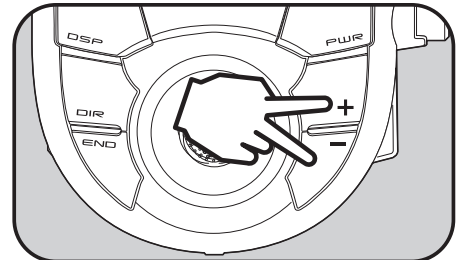

Press +/- button simultaneously to return to default value

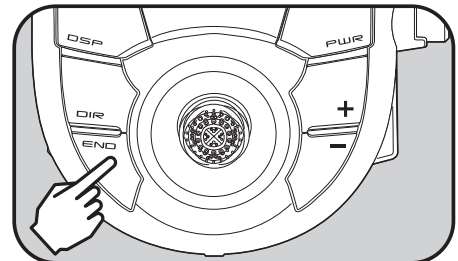

Press END to complete the setting

For items surrounded by a frame like this, you can change the settings using the +/- button.

± Button

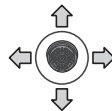

Use the jog keys to select the value want to set.

To switch between ON and OFF, select (ON) or (OFF) with the jog key and press it to ± button from ON to OFF or from OFF to ON.

*The example below shows the Battery screen.

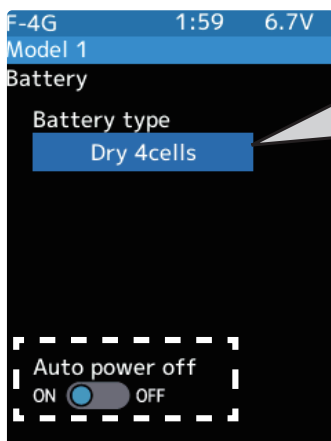

Items that are not enclosed in a frame like this can be operated with pressing the jog key (link operation, opening a selection screen, etc.).



Select with Jog key

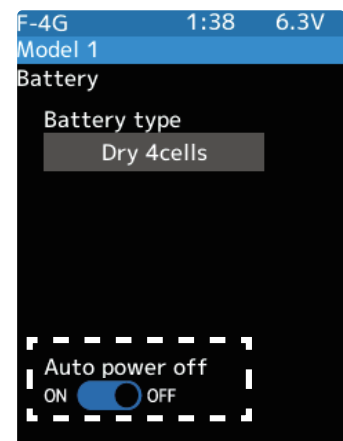

Linking Method For F-4G System

(Display when power switch turned on)

When the power switch is turned on, the currently selected model number is displayed. Check if this number is the model number you want to set-up. To change the model number, use the Model Select function.

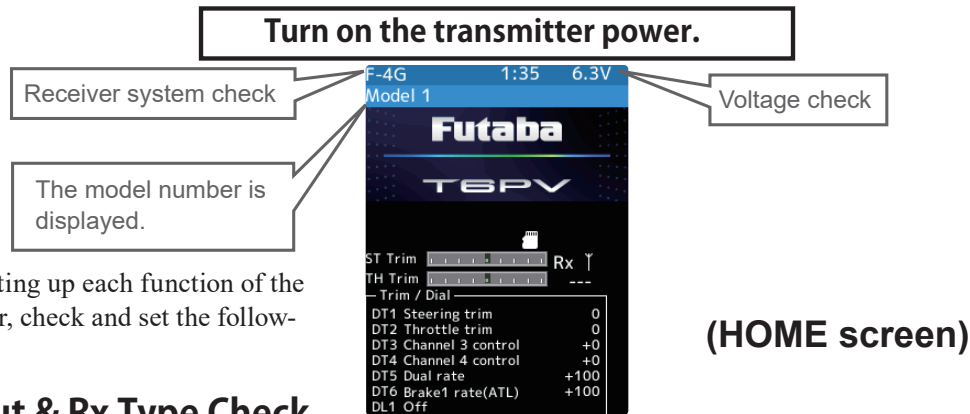

Before setting up each function of the transmitter, check and set the following items.

RF Output & Rx Type Check

Check if the receiver system is set to the type of receiver used.

*When the "PWR" side power switch is set to ON and radio waves are output normally, F-4G/T-FHSS/S-FHSS/MINI-Z EVO/MINI-Z EVO2/MINI-Z FHSS is displayed. If not displayed, there is probably an abnormality or trouble so contact a Futaba Service Center. When a screen is displayed at the "DSP" side, "Display" is displayed.

*Since the R404SBS(E) receiver supplied with the T6PV set uses the F-4G system, T6PV receiver setup must be set to F-4G.

Receiver system Change & How To Link

First set up the receiver. Setting changes are immediately reflected. Next, the transmitter and receiver are linked and the receiver memorizes the transmitter ID number so that signals from other transmitters will not be received. In addition, with the Telemetry system, the transmitter simultaneously memorizes the receiver ID numbers so that data from other receivers will not be received.

The method of setting up the receiver system and the method of linking the transmitter and receiver are described.

- 1 Set the transmitter "PWR" side power switch to ON. From the Home screen, Operate the jog key in either direction. Next, select [Receiver] at the Linkage menu and access the setup screen shown below by press the jog key.

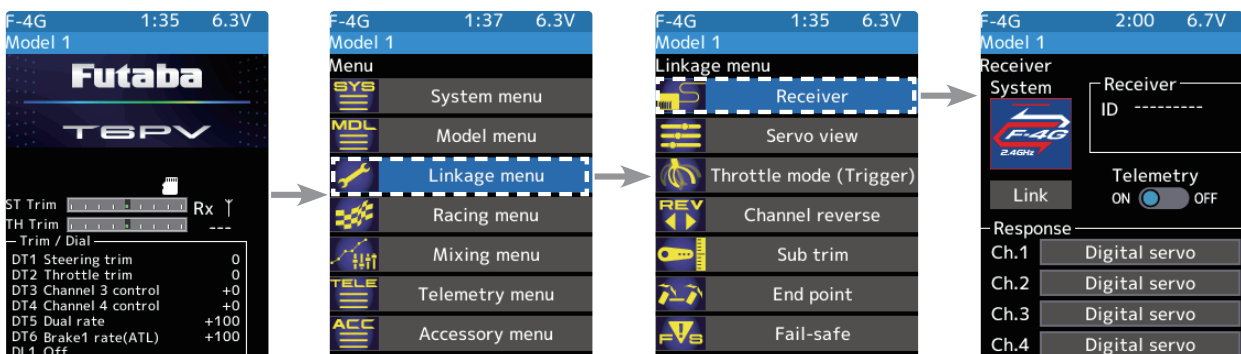

2 In "Receiver", select and press the jog key the system to be set from systems. If you change the system, be sure to link it with the receiver and turn the power on again.

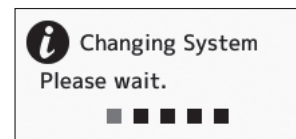

Select the system to be set from F-4G/T-FHSS/S-FHSS/MINI-Z EVO/ MINI-Z EVO2/MINI-Z FHSS.

* Even with the same receiver, if you change the system, be sure to link with the receiver and power cycle the receiver.

3 For the F-4G system, select [Analog Servo] [Digital Servo] [SR mode] [UR mode] in the receiver setting "Response" and make changes. UR/SR mode require their own dedicated servos. The display changes when the mode is changed. When using normal servo or ESC, set the Digital servo or Analog servo.

- UR mode: UR servo (Set to UR mode)
- SR mode: SR servo (Set to SR mode)
- Digital servo
- Analog servo

Receiver

Select the Ch.1(Steering)

Select the UR mode

"Please link the receiver." is display

Use UR servo for steering

Jog Key

± Botton

Note: In UR/SR mode ON, normal servo, ESC, and standard gyro will not operate.

4 When using battery fail-safe, set the Battery Fail-safe Voltage in the "Fail-safe" in the "Linkage menu".

*In the F-4G system, the Battery Fail-safe voltage is set at the time of linking. Relink when changing Battery Fail-safe voltage.

5 Bring the transmitter and receiver within 50 cm of each other (antennas do not touch) and turn on the receiver power.

6 Select [Link] on the transmitter T6PV screen, you will hear a chime sound and T6PV will enter the link mode for 20 seconds.

7 During the 20 seconds link mode, press the receiver push switch for at least 2 seconds. The LED blinks red and then changes to a greenish red → green steady light. When the T6PV makes a beeping sound and the message "Link with receiver" appears on the screen, release the receiver push switch. This ends reading of mutual ID and displays the memorized receiver ID number on the T6PV screen. Power cycle the receiver. If the "Receiver not found" error screen is displayed, linking failed. Check the set contents and repeat the linking operation.

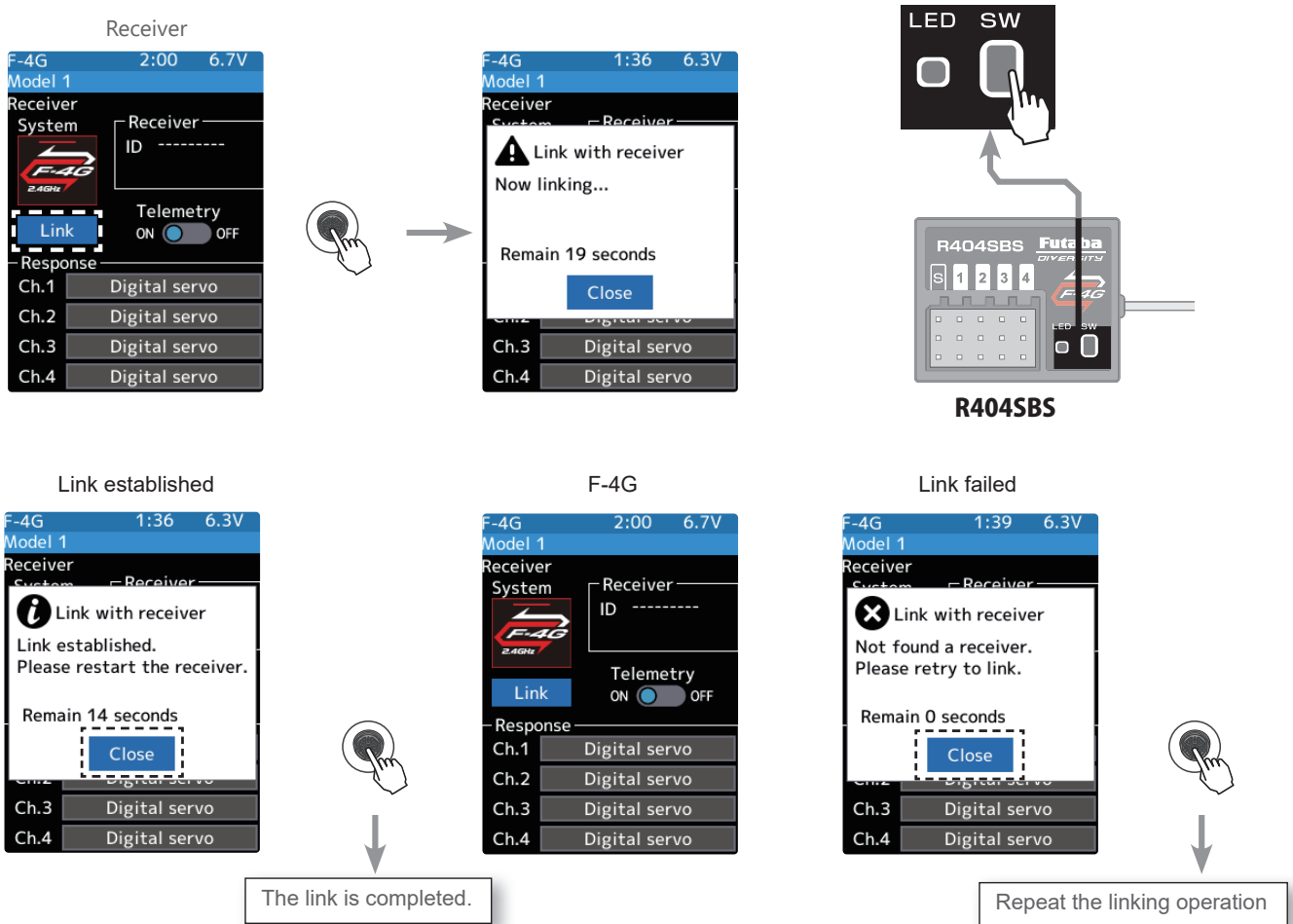

8 Once the settings are complete, turn the receiver off and then on again. The response and battery fail-safe voltage settings will take effect after the receiver is restarted.

- *The T6PV and F-4G receiver (R404SBS/R404SBS-E)/T-FHSS receiver memorize the IDs linked last at each model memory. Since only one receiver ID is memorized at each model memory, multiple F-4G/T-FHSS receivers cannot be used with the same model memory. When a receiver at the same model memory is changed, re-linking is necessary even if the receiver is already linked with the transmitter.
- *When using multiple F-4G/T-FHSS receivers, link each receiver with each T6PV model memory. However, one receiver can be linked with multiple model memories.
- *The telemetry function communication status can be checked at the T6PV home screen.
- *For other than F-4G system, the link procedure is different.

Link notice

⚠ WARNING

⊘ Do not perform the linking procedure with motor's main wire connected as it may result in serious injury.

⚠ After the linking is done, please cycle receiver power and check if the receiver to be linked is really under the control of the transmitter to be linked.

■ The settings will not be reflected unless restart.

Function Map

*The screens in this manual may differ depending on the version.

HOME

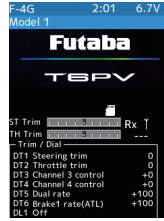

MENU

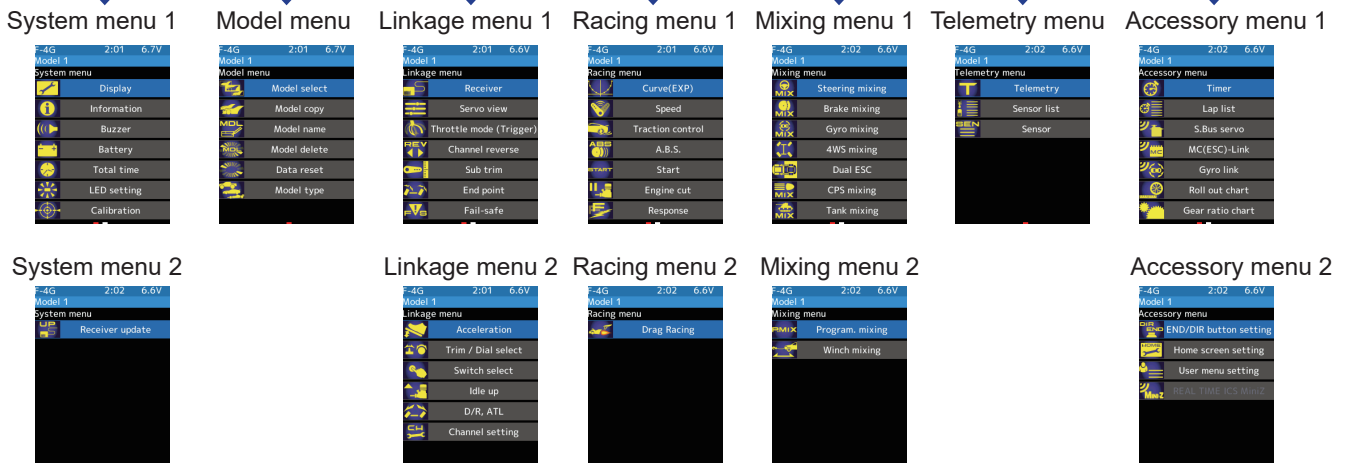

System menu



--	--	--	--	--	--	--	--

Model menu



--	--	--	--	--	--

Linkage menu

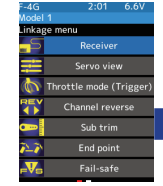

Throttle mode Channel reverse

Receiver Servo view (Trigger) Channel reverse Sub trim End point Fail-safe Acceleration

Trim / Dial select Switch select Idle up D/R, ATL Channel setting

Racing menu

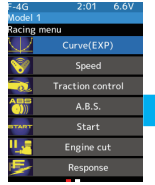

Curve (EXP) Speed Traction control A.B.S. Start Engine cut Response Drag Racing

Mixing menu

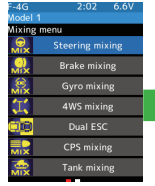

Steering mixing Brake mixing Gyro mixing 4WS mixing Dual ESC CPS mixing Tank mixing Program. mixing Winch mixing

Telemetry menu

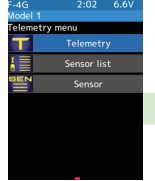

Telemetry Sensor list Sensor

Accessory menu

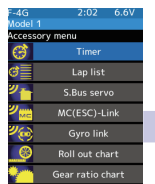

Timer Lap list S.Bus servo MC(ESC)-Link Gyro link Roll out chart Gear ratio chart END/DIR button Home screen

User menu setting REAL TIME ICS MiniZ



Display

This function is Backlight brightness, dimming time setting menu.

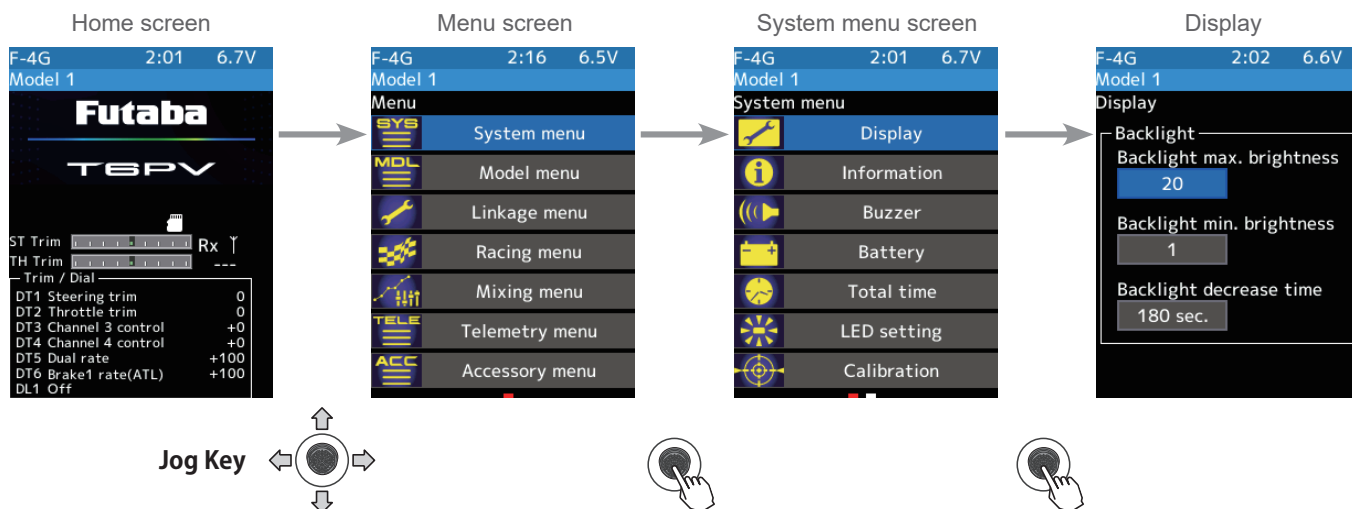

Display setup

- 1** (Backlight decrease brightness adjustment)

Select the value with jog key of the [Backlight max, brightness] or [Backlight min, brightness]. Use the [+] or [-] button to adjust the backlight decrease the brightness amount.

- The minimum is brightness when dimmed.
- 2** (Backlight decrease time)

You can set a period to decrease the LCD backlight. One-second steps can set this time. You can also turn off the backlight decrease if you like.

Select the value with jog key of the [Backlight decrease time]. Use the [+] or [-] button to adjust the backlight decrease time amount.
- 3** When finished, return to the System menu screen by pressing the END button, or press and hold the END button to return to the Home screen.

Adjust button

- Adjust with the [+] or [-] button.
- Return to the initial value by press the [+] and [-] button simultaneously.



Information

With this system information, you can select user name setting, display language, use unit of telemetry information. It also displays the software version.

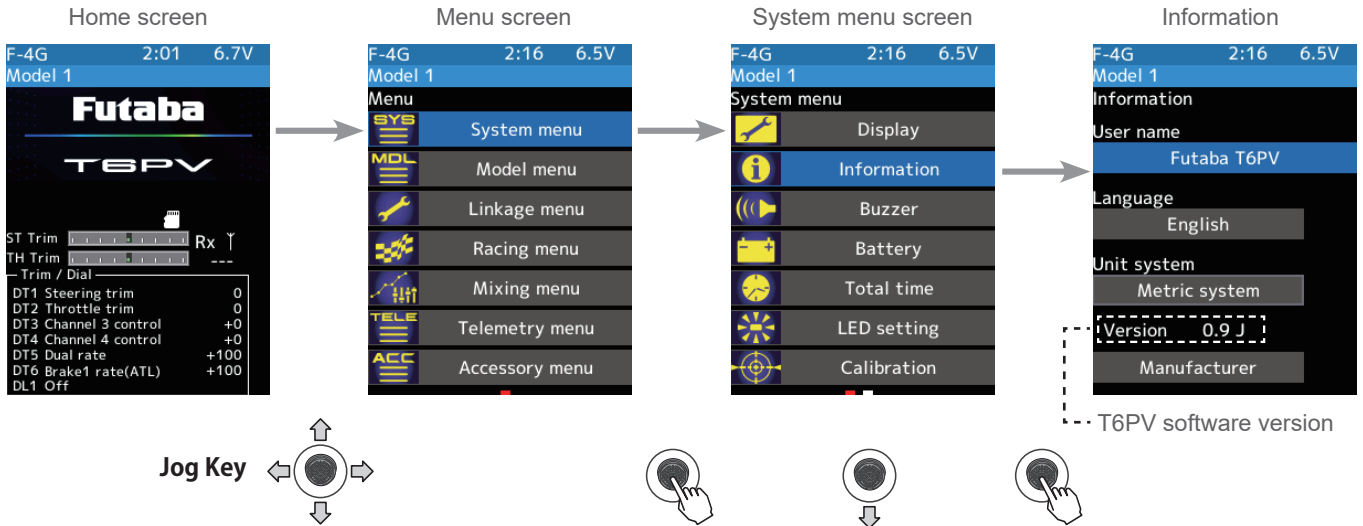

Setting the user name

- (Moving the cursor to the character you want to change.)
With the cursor on [User name], press the jog key. In the model name, Use the jog key to select [**←**] or [**→**] move the cursor and select the character of the model name you want to set or change. A vertical line cursor is displayed before the selected character.
- (Selection of characters to use)
Use the jog key to select the character you want to use from the character list, and then press the jog key. The character is determined and the character string of the model name moves to the right. If you select [BS] with the jog key and press, the left character of the vertical line cursor will be deleted. To redo, select [Undo] with the jog key and press.

Name cursor movement

Use the jog key to select [**←**] or [**→**] move the cursor. Also, when you decide a character, when the cursor position of the model name moves to the right, the cursor position of the model name moves to the right.

Select/determine character

Select a character, press jog key it to determine the character.

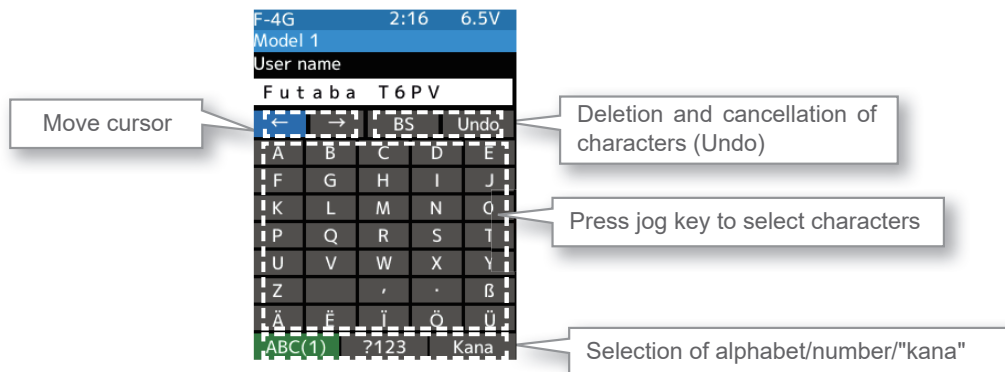

- When finished, return to the System menu screen by pressing the END button, or press and hold the END button to return to the Home screen.

Language setting

1 (Language select)

Select the [Language] with the jog key and press, a list of languages will be displayed on the screen. If you press jog key the language you want to use from the list, the language display will be changed and you will be taken to the home screen.

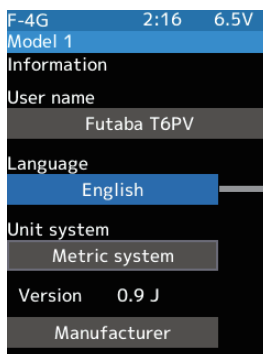

Language select

Use the jog key to select from the list and press it.



Units system setting

1 (Units system setting)

Select the [Unit System] with the jog key. Use the [+] or [-] button to set either Metric system or Yard-pound system.

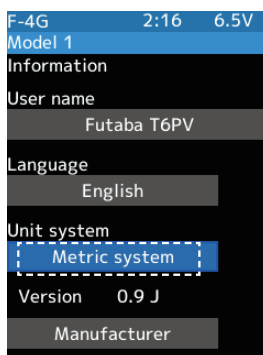

Setting

- Press [+] or [-] button
- Metric system
- Yard-pound system

Display of manufacturer information

1 (Show the manufacturer information)

Select the [Manufacturer] with the jog key and press, displays the manufacturer information.

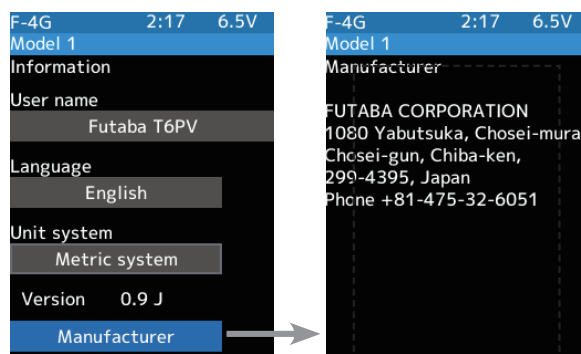

2 When finished, return to the System menu screen by pressing the END button, or press and hold the END button to return to the Home screen.



Buzzer

This function can set the sound of "Operation" and "Warning".

- The sound of when switch, dial, button, and trim are operated can be adjusted.
- The sound of the audible alarm sound can be adjusted.

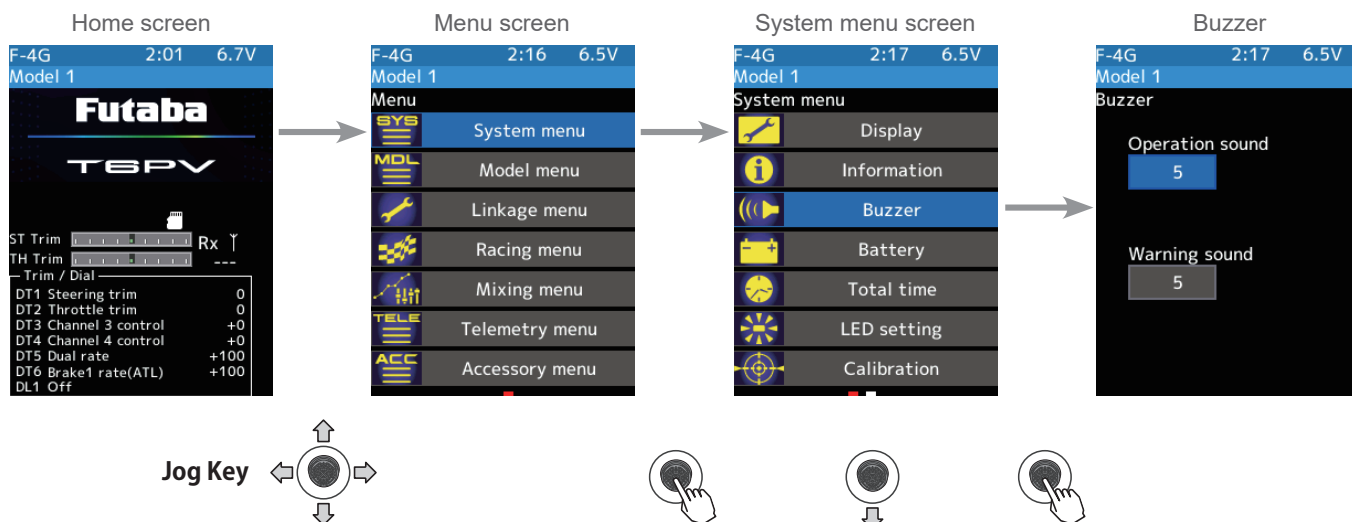

Sound adjustment

- 1** (Adjusting the operation sound)
Select the value with jog key of the [Operation sound]. Use the [+] or [-] button to adjust the sound.
- 2** (Adjusting the warning sound)
Select the value with jog key of the [Warning sound]. Use the [+] or [-] button to adjust the sound.

Adjust button

Adjust with the [+] or [-] button.
- Return to the initial value by press the [+] and [-] button simultaneously

Normal sound

INH~10
Initial value: 5

Warning sound

1~10
Initial value: 5

- 3** When finished, return to the System menu screen by pressing the END button, or press and hold the END button to return to the Home screen.





Battery

With the T6PV, the low battery alarm setting is different, depending on the type of battery. Therefore, always set the battery type to match the power supply being used. When using a Futaba rechargeable type battery, always select "LiFe 2 cells" "LiPo 2 cells" or "NiMH 5 cells". The incorrect setting will substantially shorten the time from low battery alarm to system stopping and is very dangerous.

Exceptionally, when using a battery other than this, select "Other" and set the low battery alarm voltage on your responsibility. Futaba is not responsible for the trouble caused by the use of an unspecified battery.

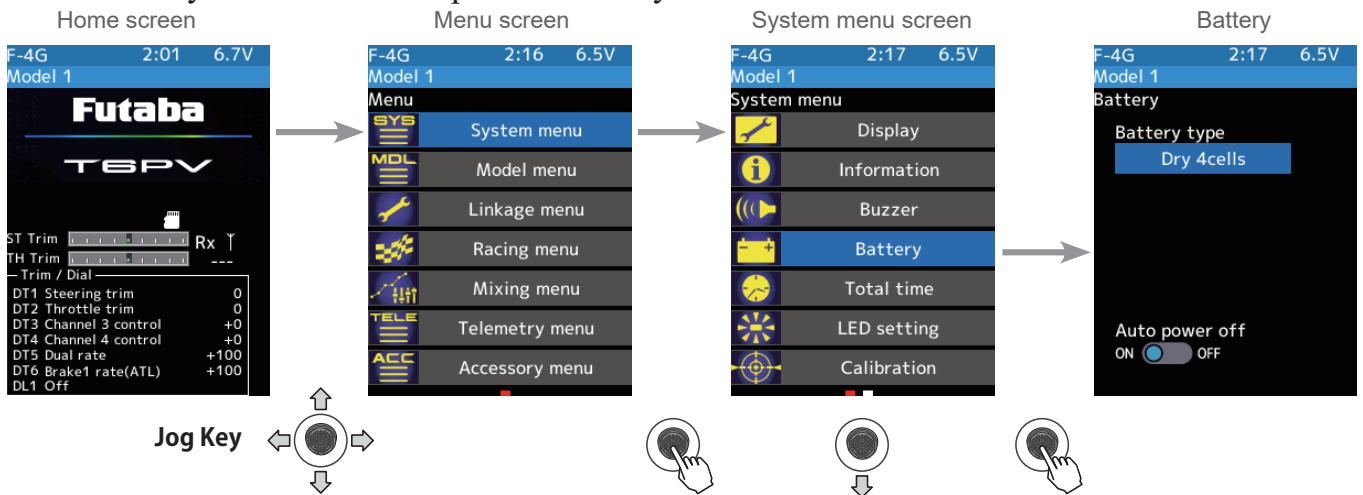

Battery setting

1 (Select battery type)

Select the [Battery type] with the jog key and press, a list of battery type will be displayed on the screen. Select the battery type you want to use from the list using the jog key and press it.

-When set to [Other], please set the alarm voltage by yourself.

Setting

- Press jog key list
- LiFe 2 cells
- LiPo 2 cells
- NiMH 5 cells
- Dry 4 cells
- Other

2 (Auto power off setting)

If the Auto Power Off setting is (ON), if the transmitter is not operated for 10 minutes, the message "Warning: Auto Power Off" will be displayed at the top of the screen and a warning sound will sound. If the steering wheel, throttle, etc. are operated at this time, the warning will be canceled. If the alarm is not canceled, the Auto Power Off function will automatically turn off the power after 5 minutes.

Select "Auto Power Off" (ON) or (OFF) with the jog key and set ON/OFF with the [+] or [-] button.

"OFF": Function OFF
"ON": Function ON

Home screen Warning

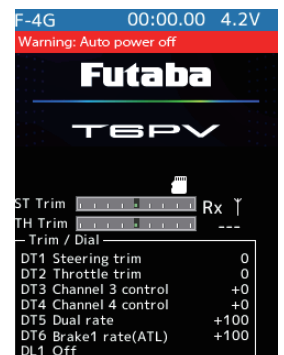

Setting

- Press [+] or [-] button (ON)/ (OFF).

3 When finished, return to the System menu screen by pressing the END button, or press and hold the END button to return to the Home screen.



Total time

Displays the total time for how long the T6PV has been turned on.

Whether the timer or the total time (accumulation timer) is displayed on the initial screen can be set. The total time can be reset at this menu.

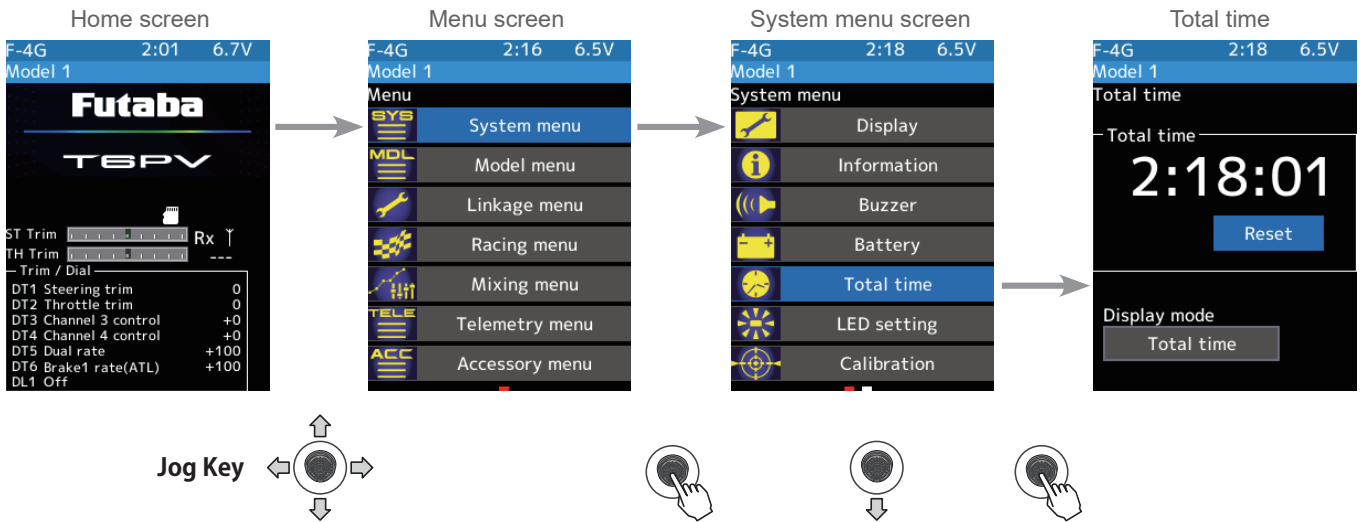

Date and time setting

- 1 (Total time reset)**
Cursor on [Reset] with the jog key and press. The total time is reset.



Total time reset
Select [reset]

- 2 (Select home screen display mode)**
Use the jog key to select "Display mode" and use the [+] or [-] button to set [Total time] or [Timer].

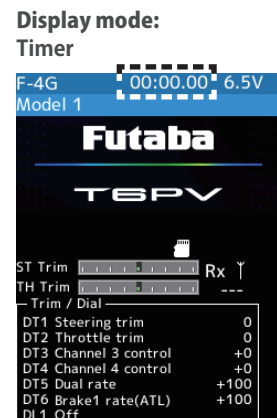

- 3** When finished, return to the System menu screen by pressing the END button, or press and hold the END button to return to the Home screen.



LED setting

Adjust the brightness and lighting method of the pilot LED light.

The pilot LED lighting method can be selected from "Always On", "Off" or "Backlight".

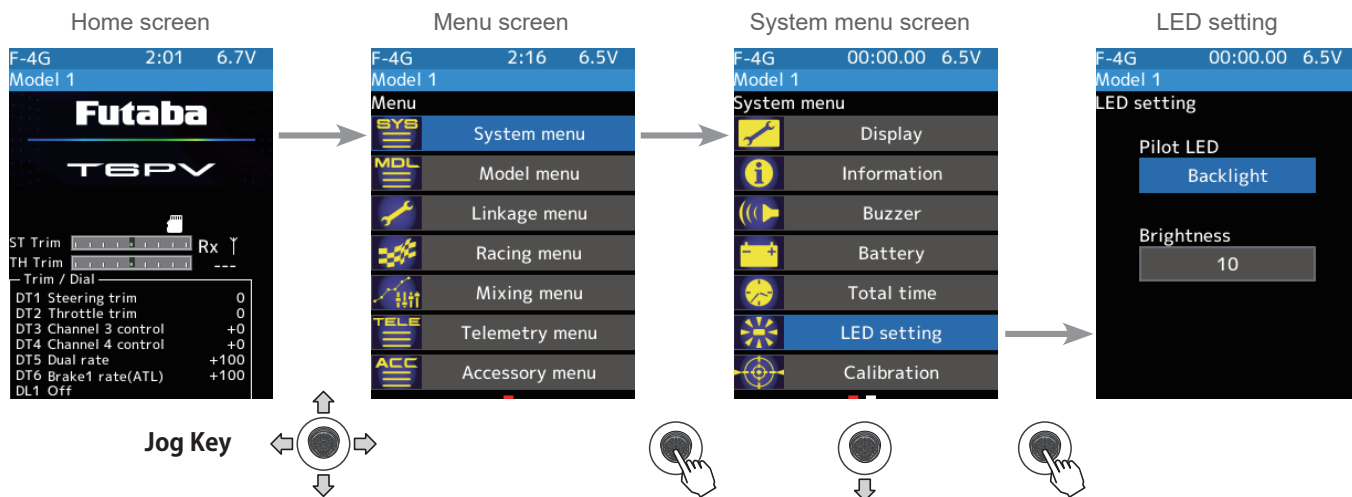

LED setting

1 (Setting pilot LED)

Select [Pilot LED] with the jog key and press, a list of lighting mode will be displayed on the screen. Select the lighting mode you want to use from the list with the jog key and press it.

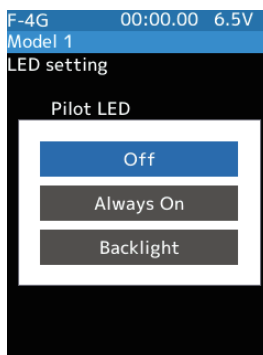

Pilot LED mode

Backlight, Always On, OFF

*Backlight:

The lighting of the LED works with the backlight.

2 (Setting Pilot LED brightness)

Select the value with jog key of the [Brightness]. Use the [+] or [-] button to adjust the pilot LED brightness amount.

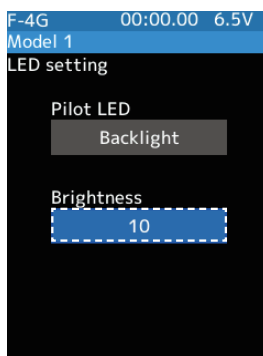

Adjust button

Adjust with the [+] or [-] button.

- Return to the initial value by press the [+] and [-] button simultaneously

Brightness

0~20

Initial value: 10

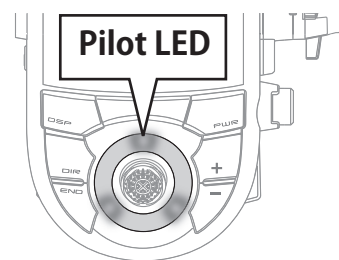

3 When finished, return to the System menu screen by pressing the END button, or press and hold the END button to return to the Home screen.



Calibration

Steering and throttle correction can be applied. Use this function when a mechanical offset has occurred for some reason.

However, if correction was applied, it may be necessary to recheck the set values of all the setup functions.

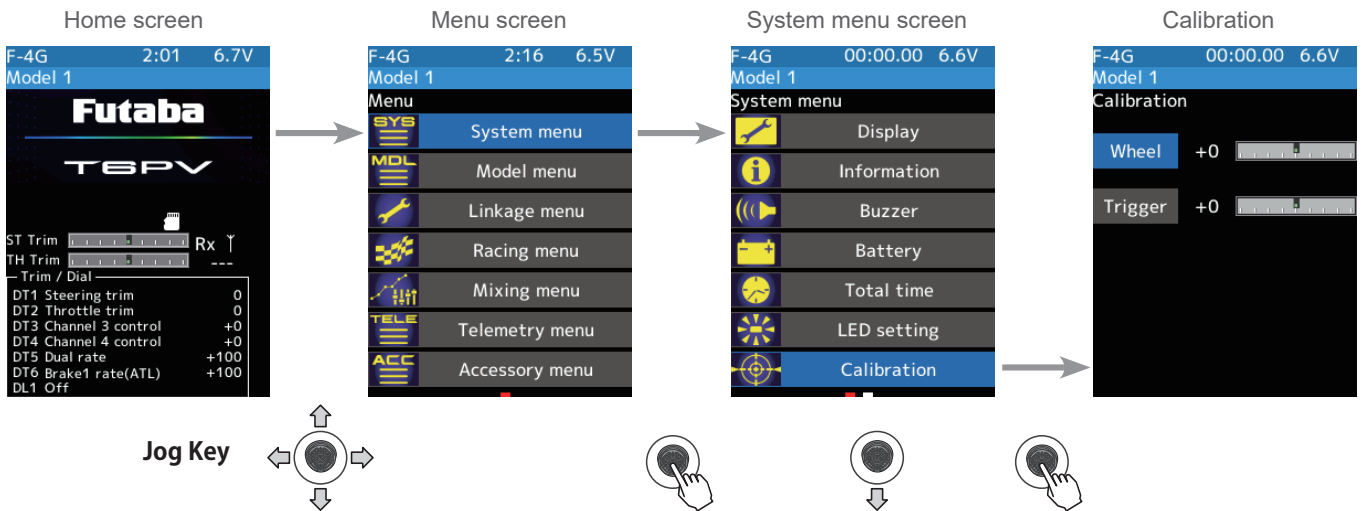

Steering adjustment

(Preparation)

Select [Wheel]. The neutral correction screen appears.

1 (Steering neutral adjustment)

At neutral, turn the steering wheel left and right. With the steering wheel in the neutral position, select and press [Neutral] with the jog key. If the [Neutral] position is OK, the [End Point] button will appear after pressing the [Neutral] button. If not within the correction range, the [End Point] button will not appear.

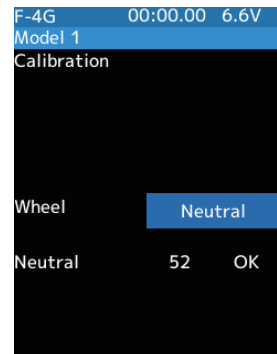

2 (Steering wheel travel adjustment)

With the [End point] displayed on the Wheel, slowly move the wheel all the way to the left and right. When each OK is displayed, the cursor will show [Enter]. Press the jog key. If the [End Point] correction is OK, the display will return to the calibration screen. If the end point is not within the correction range, the display does not [Enter]. In this case, return to the system menu screen by pressing the END button, or press and hold the END button to return to the Home screen. If the operation cannot usually be ended even when correction is repeated, please contact the Futaba Service Center.

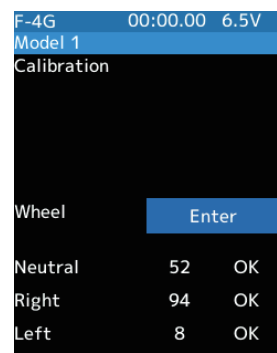

3

When finished, return to the System menu screen by pressing the END button, or press and hold the END button to return to the Home screen.

Throttle adjustment

(Preparation)

Select [Trigger]. The neutral correction screen appears.

1 (Throttle neutral adjustment)

Operate the throttle trigger to full throttle and brake side, then return it to neutral. Select and press [Neutral] with the jog key. If the [Neutral] position is OK, the [End Point] button will appear after pressing the [Neutral] button. If not within the correction range, the [End Point] button will not appear.

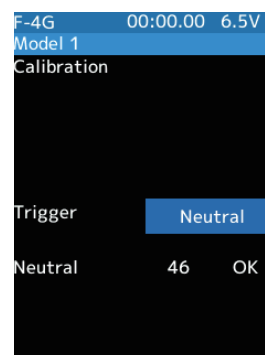
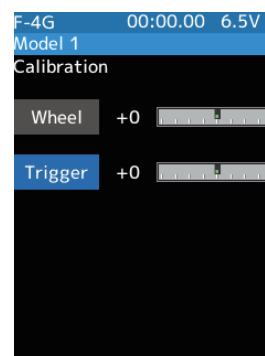

2 (Throttle trigger travel adjustment)

With the [End point] displayed on the Trigger, slowly move the trigger to full throttle and full braking. When each OK is displayed, the cursor will show [Enter]. Press the jog key. If the [End Point] correction is OK, the display will return to the calibration screen. If the end point is not within the correction range, the display does not [Enter]. In this case, return to the system menu screen by pressing the END button, or press and hold the END button to return to the Home screen. If the operation cannot usually be ended even when correction is repeated, please contact the Futaba Service Center.

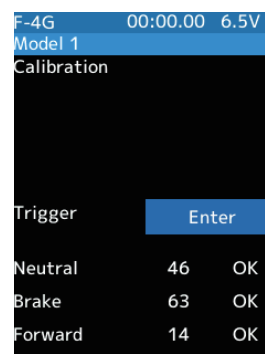

3 When finished, return to the System menu screen by pressing the END button, or press and hold the END button to return to the Home screen.

Receiver update

It is a function for updating the program of Futaba R404SBS/R404SBS-E/R334SBS/R334SBS-E receiver from T6PV.

To update the receiver, you need a PC that can be connected to the Internet, a mini driver (to push the switch of the receiver), a micro SD card (commercial product), and a cord for CGY750/GY701/GY520 (optional) or DSC cord (optional).



Preparing for update

- Download the zip file of the update data from our website or your local distributor's website.
- Extract the zip file on your computer. A folder named "FUTABA" is created.
- Insert the micro SD card that contains the "FUTABA" folder into the T6PV.

The connection between T6PV and receiver

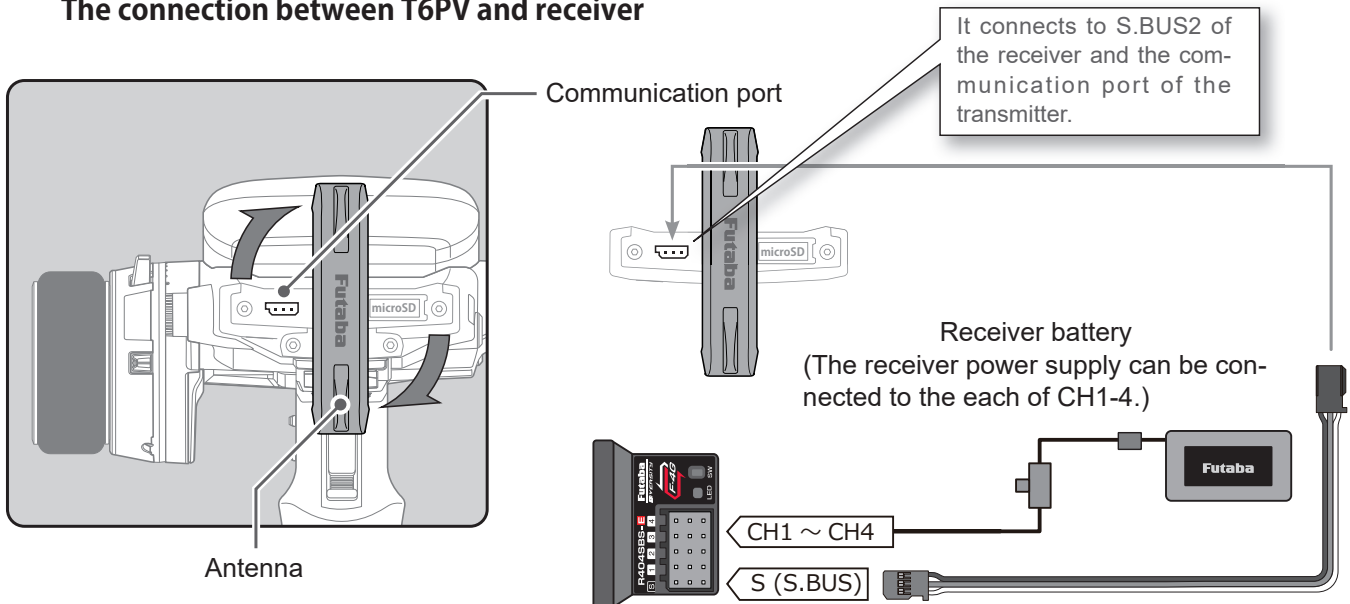

Turn on the DSP or PWR switch of T6PV and display the receiver update screen.

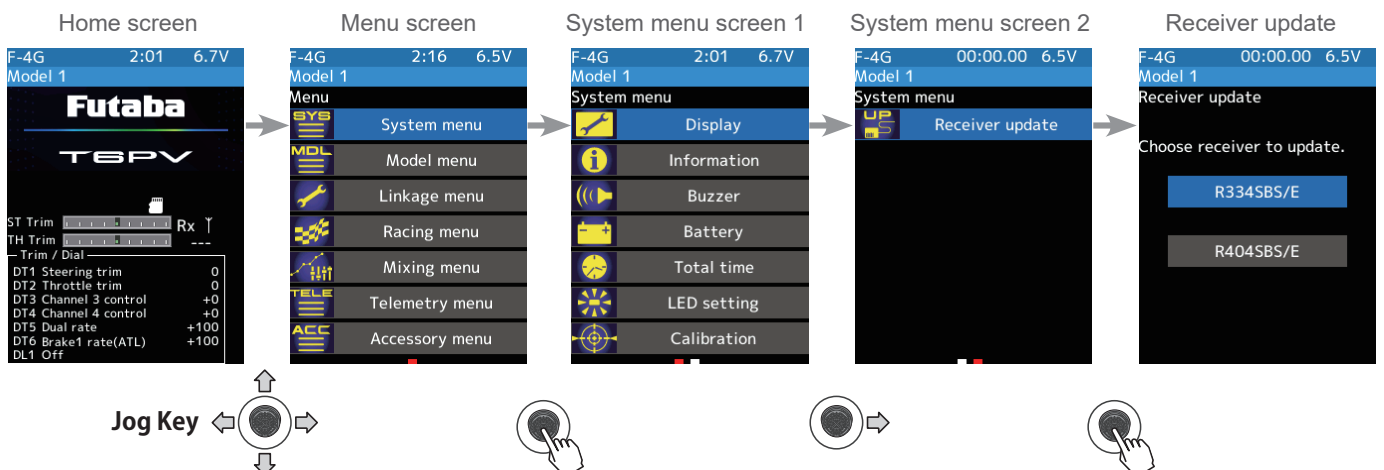

Update method

- 1 Use the jog key select the receiver to update on the “Receiver update” screen.

- Only the displayed receiver can be updated with T6PV.

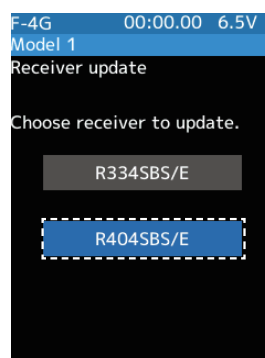

- 2 Hold down the receiver Link switch first, and turn ON the receiver.

After the LED flashes red once, release the Link switch and then press it again.

As you continue holding down the Link switch, the LED starts flashing red and green. (Once flashing Red and Green, the initial process is complete.)

- If red and green do not turn on at the same time, please start over from the beginning.

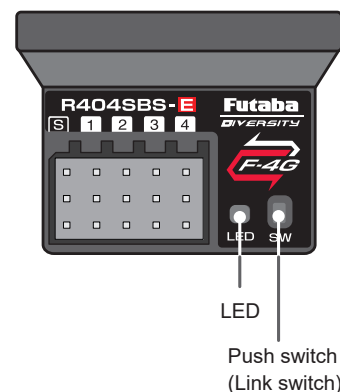

- 3 Press jog key the "Update" button on the screen. The update will start. A progress bar will be displayed indicating the progress. The LED of the receiver turns green, and it blinks green for a moment every time it accepts data from the T6PV.

- Do not turn off the power of T6PV while updating.

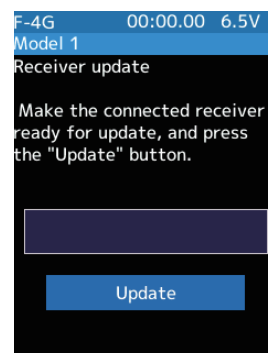

- 4 When the update is completed, a message is displayed on the screen, and the LED of the receiver stays flashing green. Please turn off the power of the receiver. Be sure to check the operation before running (cruising).

- 5 When finished, return to the System menu screen by pressing the END button, or press and hold the END button to return to the Home screen.

Error

If an error display appeared, reinstall the update from the beginning.

- The receiver is not in the update wait state.
- The cable is disconnected.
- The power has been turned off
- The micro SD card is not inserted in the T6PV.
- There is no data on micro SD card.



Model select

Forty model data (model data for 40 R/C cars) can be saved in the T6PV transmitter and used when the relevant model data selected. However, models copied in the microSD card cannot be used by directly calling from the card. Please copy it to the T6PV main unit when using it.

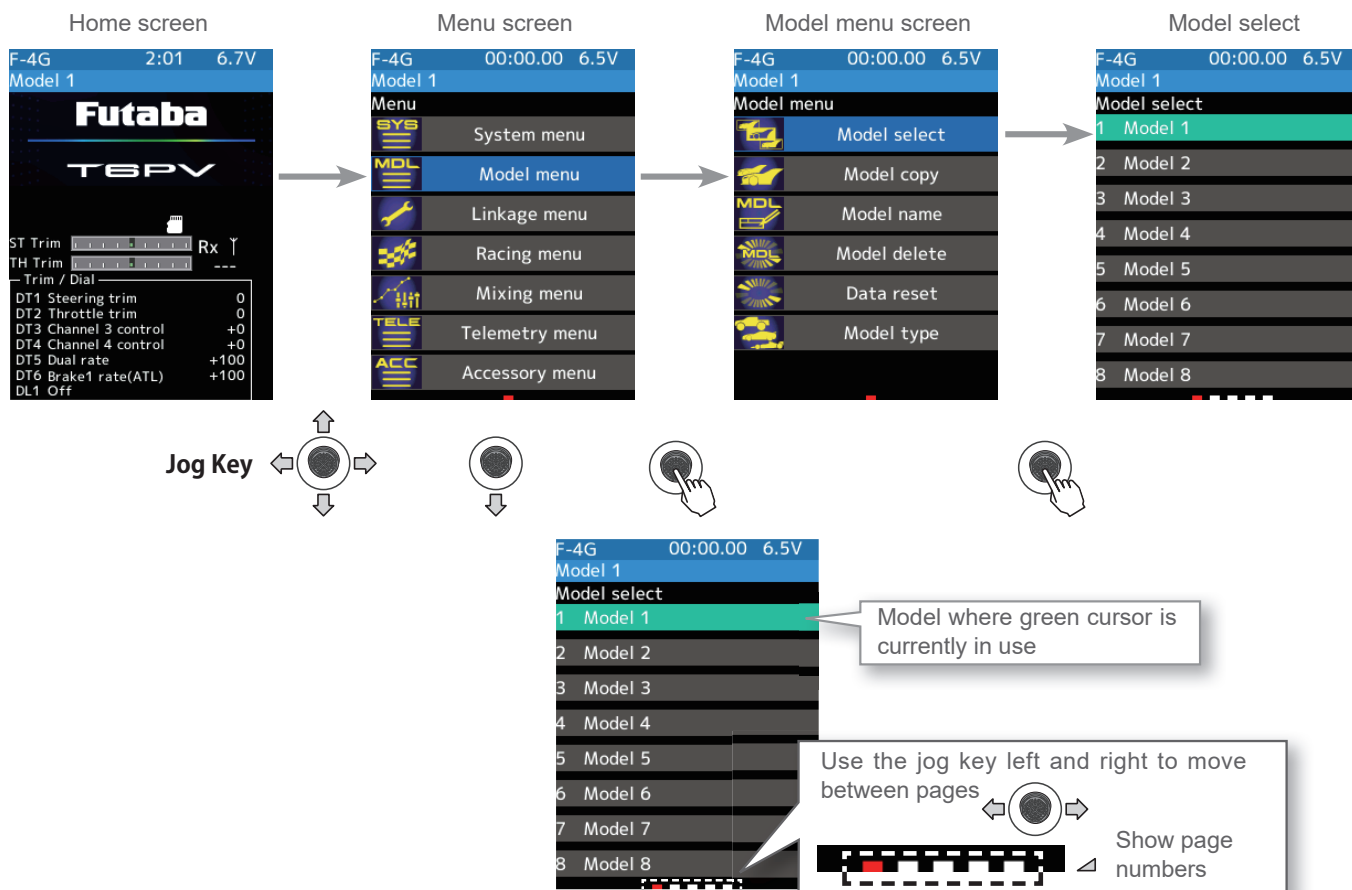

Using the model selection function

1 (Model memory selection)
You can choose from 8 models on one page and 40 models on five pages. Use the jog key left and right to turn the pages.

2 (Model selection execution)
Select [Model name] to use, and a confirmation screen will be displayed, saying, "Are you sure?" to execute, Select the [Yes] with the jog key and press, a beep sounds and the change are completed, and the home screen is displayed. To cancel, Select the [No].

- If the model name of the home screen is changed, model selection is completed.

3 When finished, return to the Model menu screen by pressing the END button, or press and hold the END button to return to the Home screen.

Model #.
M1~M40

Model selection
- Select [Model name]

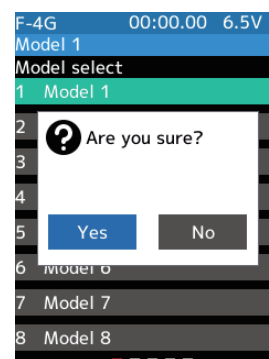



MODEL MENU



Model copy

The contents of model memory can copy to another model memory. You can also save content to a microSD card for backup or to copy to another T6PV.

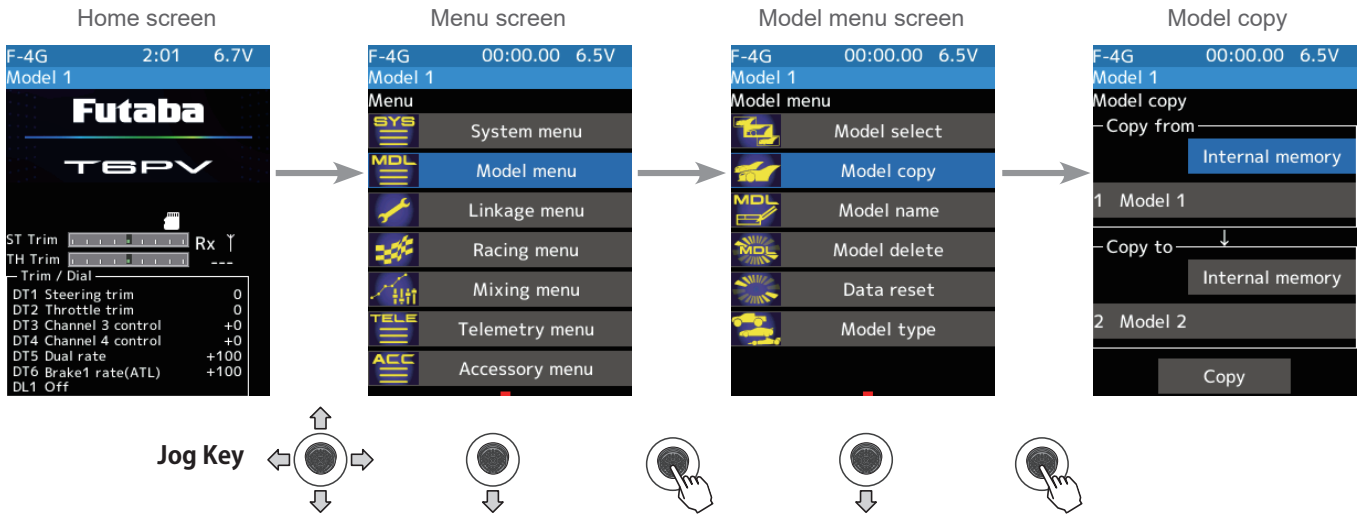

Model copying

1 (Copy source model selection)

Choose from 8 models on 1 page and 40 models on 5 pages. Use the jog key left and right to turn the pages.

Copy source

Use the jog key to select from the list and press it.

2 (Model selection execution)

Press jog key the "Copy from" [model name] with the jog key and press, select the model list, so it press jog keys. The source model is selected, and the model list is close. The list is the same design as the model selected, and the way of moving the page is the same. If a microSD card installed in the T6PV main unit, a button for selecting either the model inside the T6PV main unit or the model inside the microSD card show, so press jog key to select it.

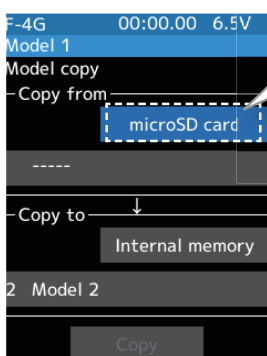
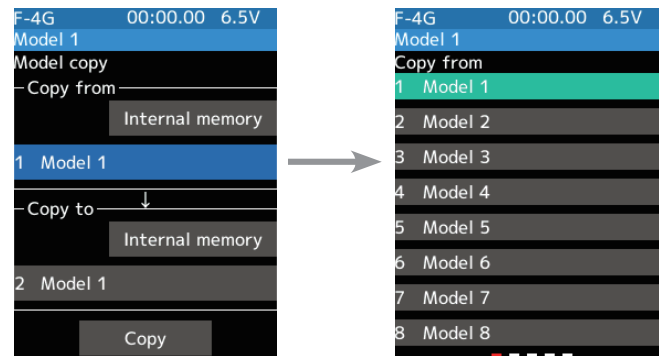

Press jog key to select the model of the T6PV main body or the model inside the SD card.

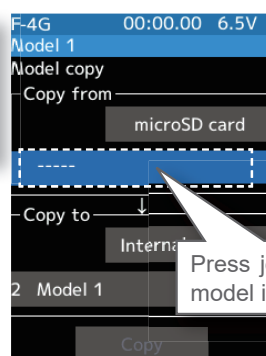

Press jog key to view the model in the SD card

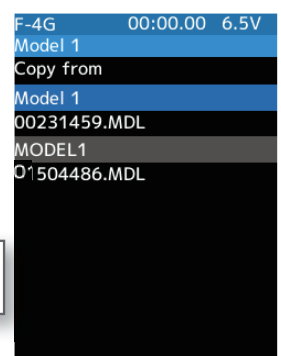

3 (Copy destination model selection)
 Press jog key the "Copy to" [model name] with the jog key and press, select the model list so it will press jog key. The source model is selected, and the model list is closed.

- The model currently in use cannot be selected.
- Since the copy destination cannot be overwritten when it is in a microSD card, a model list is not displayed, and the model is saved directly to the microSD card.

Copy destination
 Use the jog key to select from the list and press it.

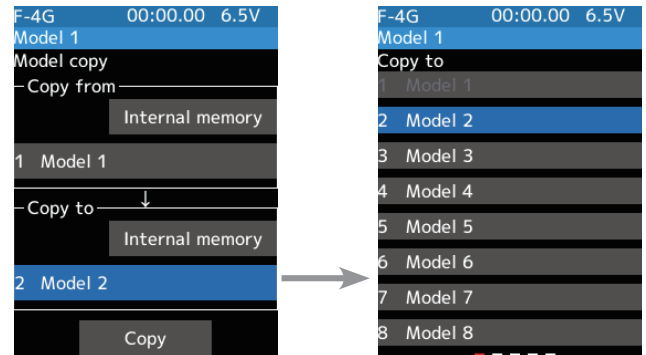

4 (Copy execution)
 Select [Copy]. The confirmation message "Are you sure" appears. To execute the copy, Select the [Yes] and to cancel copy, select [No]. When the copy destination model name becomes the same name as the copy source, copying is complete.

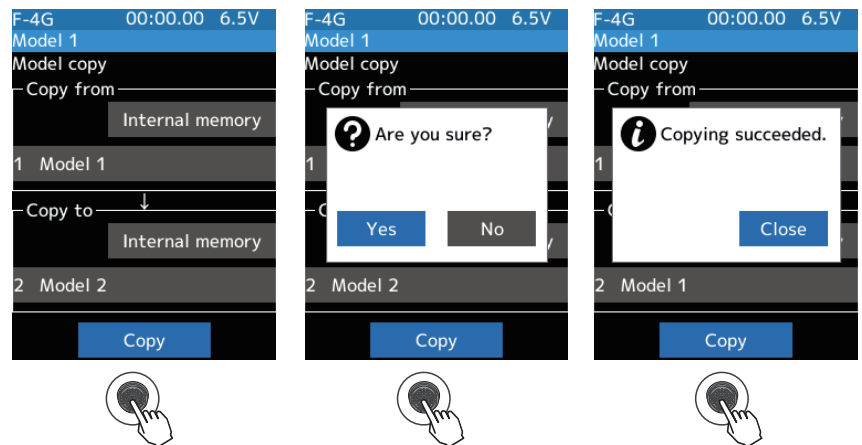

5 When finished, return to the Model menu screen by pressing the END button, or press and hold the END button to return to the Home screen.

The microSD card storage destination

When a microSD card is installed in the T6PV, a folder called "Futaba" is created, and folders called "LOG" and "MODEL" are created in it. The "MODEL" folder contains the model data.

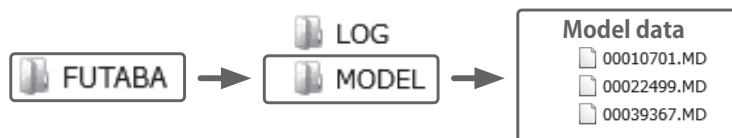
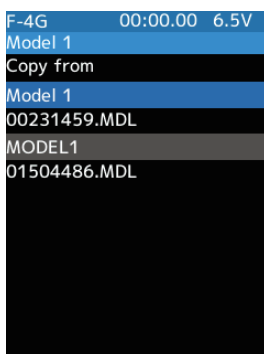

When the T6PV model data is copied, and the copy source data is selected from the model data stored in the microSD, a model list like that shown at the left is displayed.



MODEL MENU



Model name

This function allows you to assign a name up to 15 characters, to each model memory.

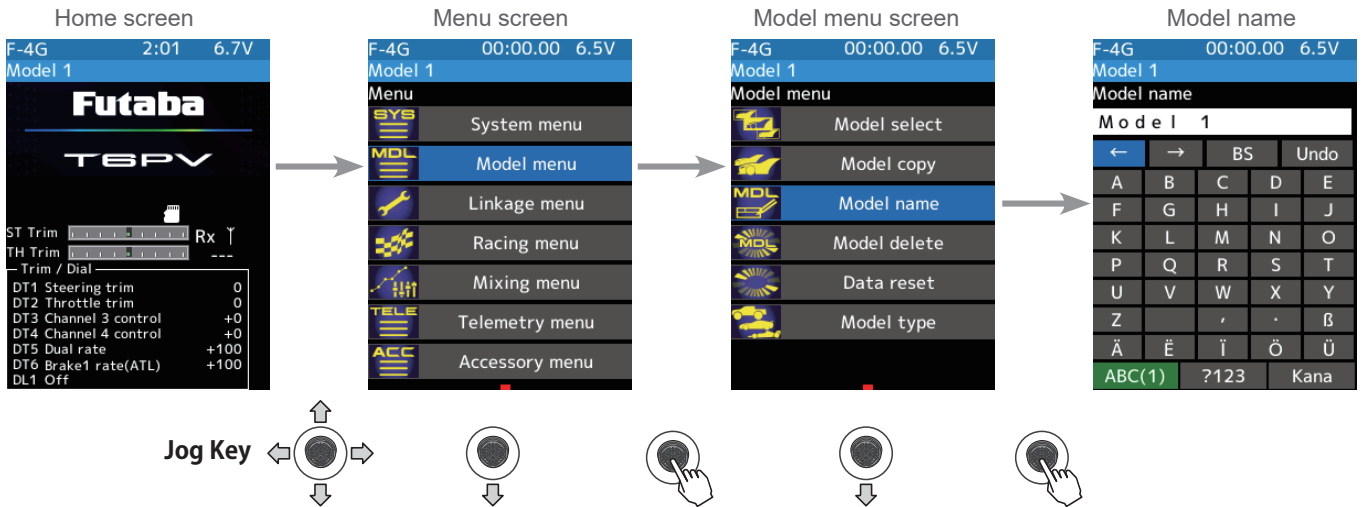

Setting the model name and user name

- (Moving the cursor to the character you want to change.)
In the model name, Select the [←] [→] with the jog key and press, [←] [→] to move the cursor and select the character of the model name you want to set or change. A vertical line cursor is displayed before the selected character.
- (Selection of characters to use)
Select the character to use from the list. When you decide the character to use, press jog key it. The character is determined, and the character string of the model name moves to the right. If you Select the [BS] with the jog key and press, the left character of the vertical line cursor deleted. To redo, Select the [Undo].

Name cursor movement

Use the [←]/[→] press jog key to move the cursor. Also, when you decide a character, when the cursor position of the model name moves to the right.

Select/determine character

Select a character, press jog key it to determine the character.

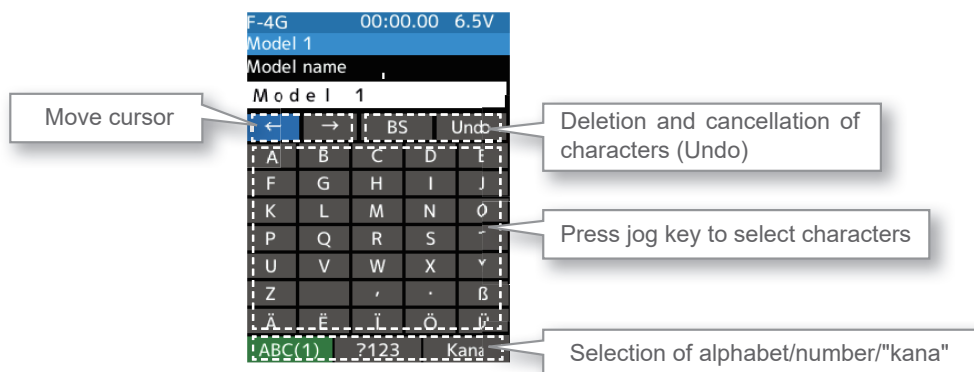

- When finished, return to the Model menu screen by pressing the END button, or press and hold the END button to return to the Home screen.



MODEL MENU



Model delete (Model saved on microSD card)

This function deletes model data saved on the microSD card.

Model deletion is displayed on the menu only when the microSD card is set in the T6PV card slot.

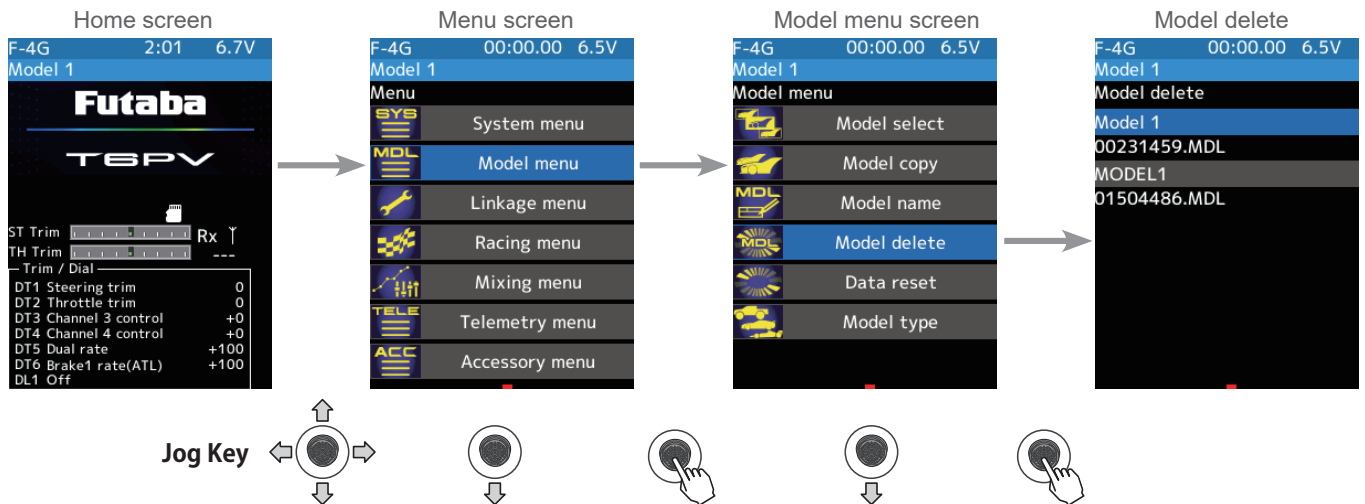

How to delete model data in the microSD card

- 1** (Selection of model data)

If the number of models that do not fit on one page memo-rizes, use the jog key left and right to turn the pages.
- 2** (Execution of model deletion)

Press jog key the model you want to delete. A confirmation message "Are you sure?" appears. Select the [Yes] to ex-ecute the deletion, or [No] to cancel.

"Deleting succeeded" is displayed and deletion is completed.

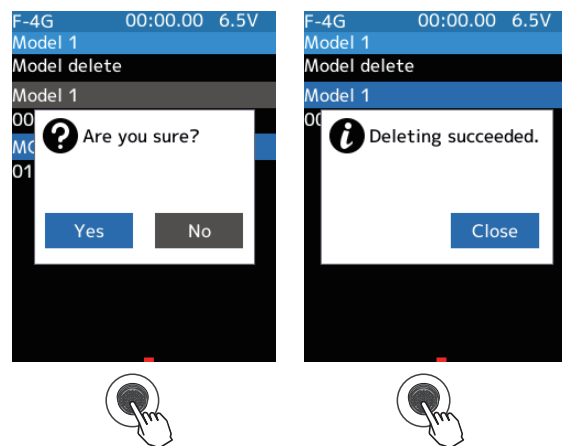

- 3** When finished, return to the Model menu screen by pressing the END button, or press and hold the END button to return to the Home screen.



Data reset

This function resets the contents of the currently called model memory.

The reset method can be selected from among the four types described below. These resets do not initialize the calibration function and system function.

-Model data

This mode is Initializes only the function setting data. The direct menu function is not initialized.

-User menu

This mode is Initializes the user menu function. Other settings are not initialized.

-Telemetry

Telemetry related setup data is initialized.

-All data

This mode is Initializes the direct selection function, receiver setting function, and the setting data of each function.

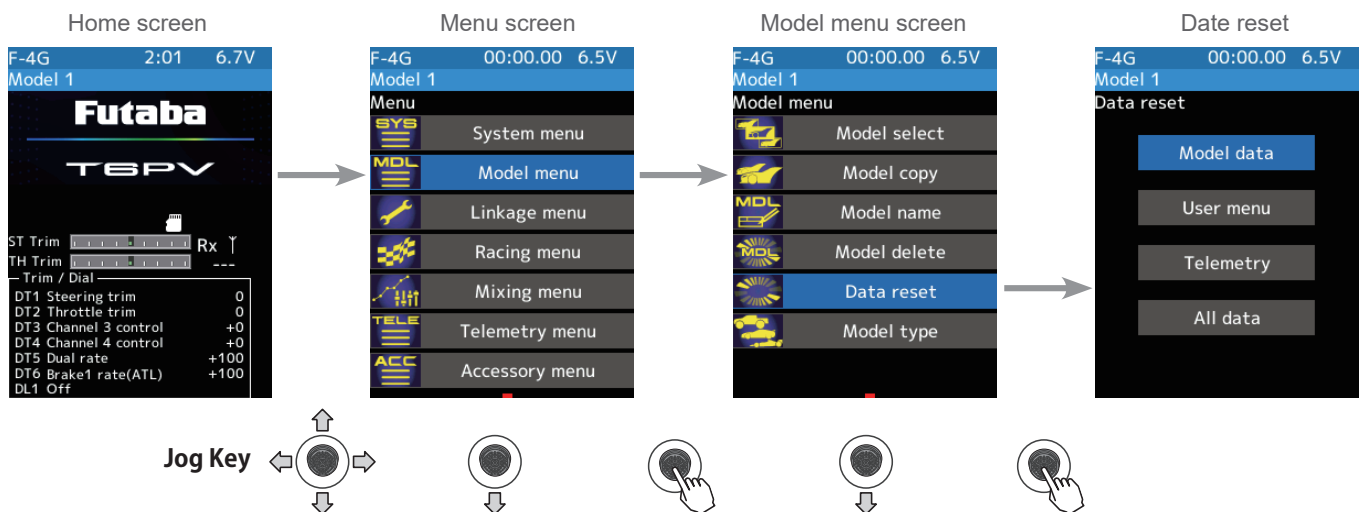

Data Reset

1 (Execution of reset)

Select the type you want to reset and press jog key. A confirmation message will be displayed as "Are you sure?" If you want to execute, Select the [Yes] to execute. Reset is now complete.

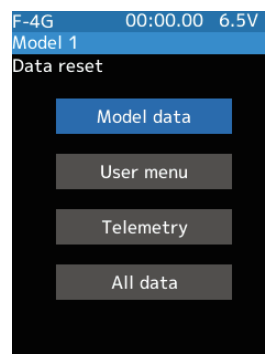

Reset execution

Select [reset type]

Reset type

- Model data
- User menu
- Telemetry
- All data



2 When finished, return to the Model menu screen by pressing the END button, or press and hold the END button to return to the Home screen.



Model type

It can be changed to the initial setting suitable for 1/5 big car and drift car. Also, the user menu changes the layout for each model type. For example, for 1/5 big cars, steering mixing and brake mixing are set to ON in advance, and drift is set to gyro mixing, so it is easy to set each type of machine.

- Changing the model type will initialize the current model data.
- It is recommended to change before setting each function.
- In [Normal] with the jog key and press, the default setting for all mixing is OFF.

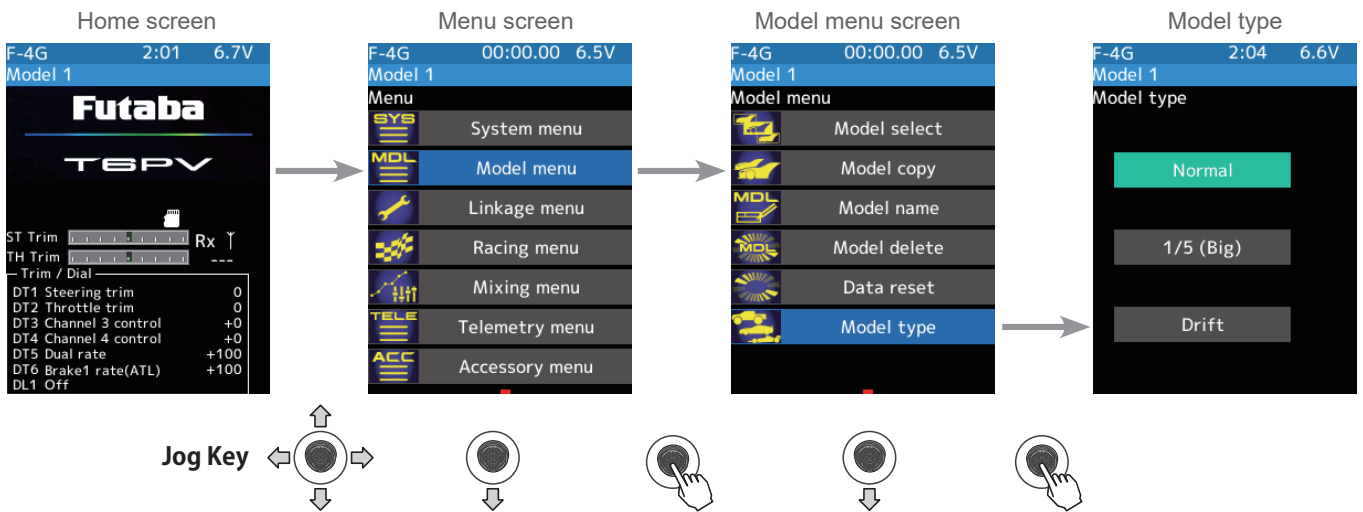

1/5(Big)

- ◆ Steering mixing : ON Ch3→Steering 2 Function
- ◆ Brake mixing : ON Ch4→Brake 2 Function DL1→Brake 2 Rate

Drift

- ◆ Gyro mixing : ON Ch3→Gyro Function DL1→Gyro Gain (Step→1)

Change model type.

- 1 Select the desired model type and press jog key it. A confirmation message will be displayed as "Caution!! The current model data will be initialized. Sure?" If you want to execute, Select the [Yes] to execute. Change model type is now complete.

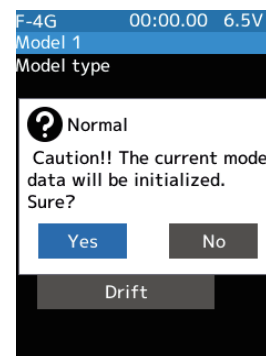
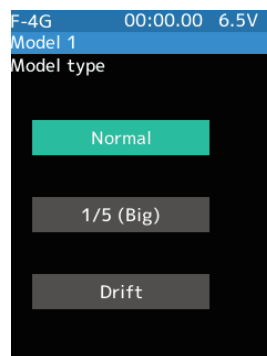

- Change execution**
Select [Model type]
- Reset type**
- Normal
 - 1/5 (Big)
 - Drift

- 2 When finished, return to the Model menu screen by pressing the END button, or press and hold the END button to return to the Home screen.



LINKAGE MENU



Receiver

This menu selects the settings matched to the receiver system used and the type of servo and the items selected at the T6PV, linking of the T6PV with the telemetry system, and ON/OFF.

Linking Method For F-4G System

(Display when power switch turned on)

When the power switch is turned on, the currently selected model number is displayed. Check if this number is the model number you want to set-up. To change the model number, use the Model Select function.

Turn on the transmitter power.

(HOME screen)

Before setting up each function of the transmitter, check and set the following items.

RF Output & Rx Type Check

Check if the receiver system is set to the type of receiver used.

*When the "PWR" side power switch is set to ON and radio waves are output normally, F-4G/T-FHSS/S-FHSS/MINI-Z EVO/MINI-Z EVO2/MINI-Z FHSS is displayed. If not displayed, there is probably an abnormality or trouble so contact a Futaba Service Center. When a screen is displayed at the "DSP" side, "Display" is displayed.

*Since the R404SBS(E) receiver supplied with the T6PV set uses the F-4G system, T6PV receiver setup must be set to F-4G.

Receiver system Change & How To Link

First set up the receiver. Setting changes are immediately reflected. Next, the transmitter and receiver are linked and the receiver memorizes the transmitter ID number so that signals from other transmitters will not be received. In addition, with the Telemetry system, the transmitter simultaneously memorizes the receiver ID numbers so that data from other receivers will not be received.

The method of setting up the receiver system and the method of linking the transmitter and receiver are described.

- 1 Set the transmitter "PWR" side power switch to ON. From the Home screen, Operate the jog key in either direction. Next, select [Receiver] at the Linkage menu and access the setup screen shown below by press the jog key.

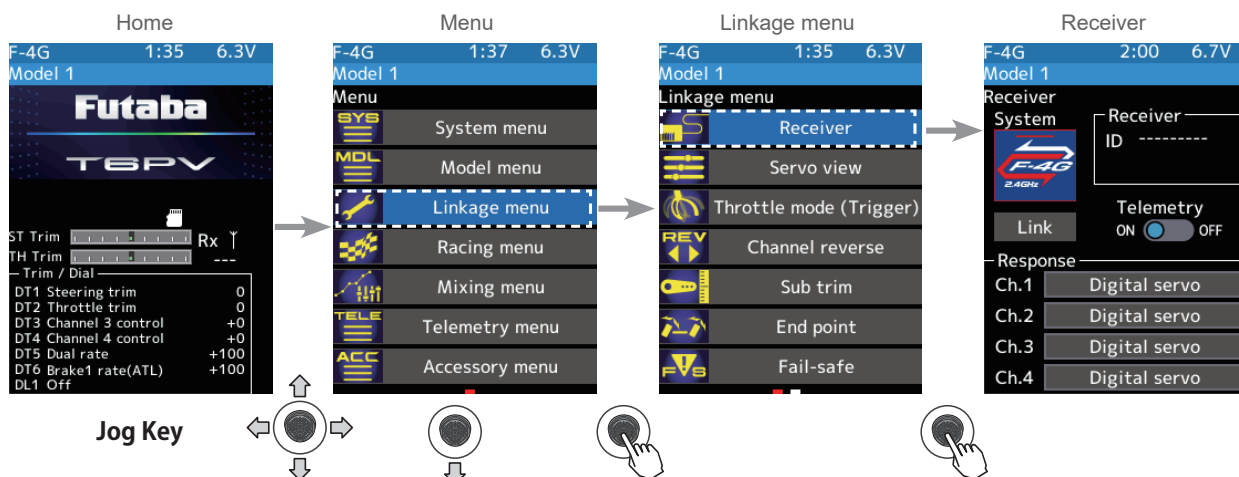



LINKAGE MENU

- 2** In "Receiver", select and press the jog key the system to be set from systems. If you change the system, be sure to link it with the receiver and turn the power on again.

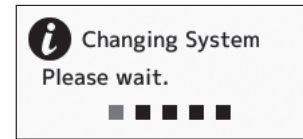

Select the system to be set from F-4G/T-FHSS/S-FHSS/MINI-Z EVO/MINI-Z EVO2/MINI-Z FHSS.

* Even with the same receiver, if you change the system, be sure to link with the receiver and power cycle the receiver.

- 3** For the F-4G system, select [Analog Servo] [Digital Servo] [SR mode] [UR mode] in the receiver setting "Response" and make changes. UR/SR mode require their own dedicated servos. The display changes when the mode is changed. When using normal servo or ESC, set the Digital servo or Analog servo.

- UR mode: UR servo (Set to UR mode)
- SR mode: SR servo (Set to SR mode)
- Digital servo
- Analog servo

Receiver

Select the Ch.1(Steering)

Select the UR mode

"Please link the receiver." is display

Use UR servo for steering

Jog Key

± Button

Note: In UR/SR mode ON, normal servo, ESC, and standard gyro will not operate.

- 4** When using battery fail-safe, set the Battery Fail-safe Voltage in the "Fail-safe" in the "Linkage menu".

*In the F-4G system, the Battery Fail-safe voltage is set at the time of linking. Relink when changing Battery Fail-safe voltage.

- 5** Bring the transmitter and receiver within 50 cm of each other (antennas do not touch) and turn on the receiver power.

- 6** Select [Link] on the transmitter T6PV screen, you will hear a chime sound and T6PV will enter the link mode for 20 seconds.



LINKAGE MENU

7 During the 20 seconds link mode, press the receiver push switch for at least 2 seconds. The LED blinks red and then changes to a greenish red → green steady light. When the T6PV makes a beeping sound and the message "Link with receiver" appears on the screen, release the receiver push switch. This ends reading of mutual ID and displays the memorized receiver ID number on the T6PV screen. Power cycle the receiver. If the "Receiver not found" error screen is displayed, linking failed. Check the set contents and repeat the linking operation.

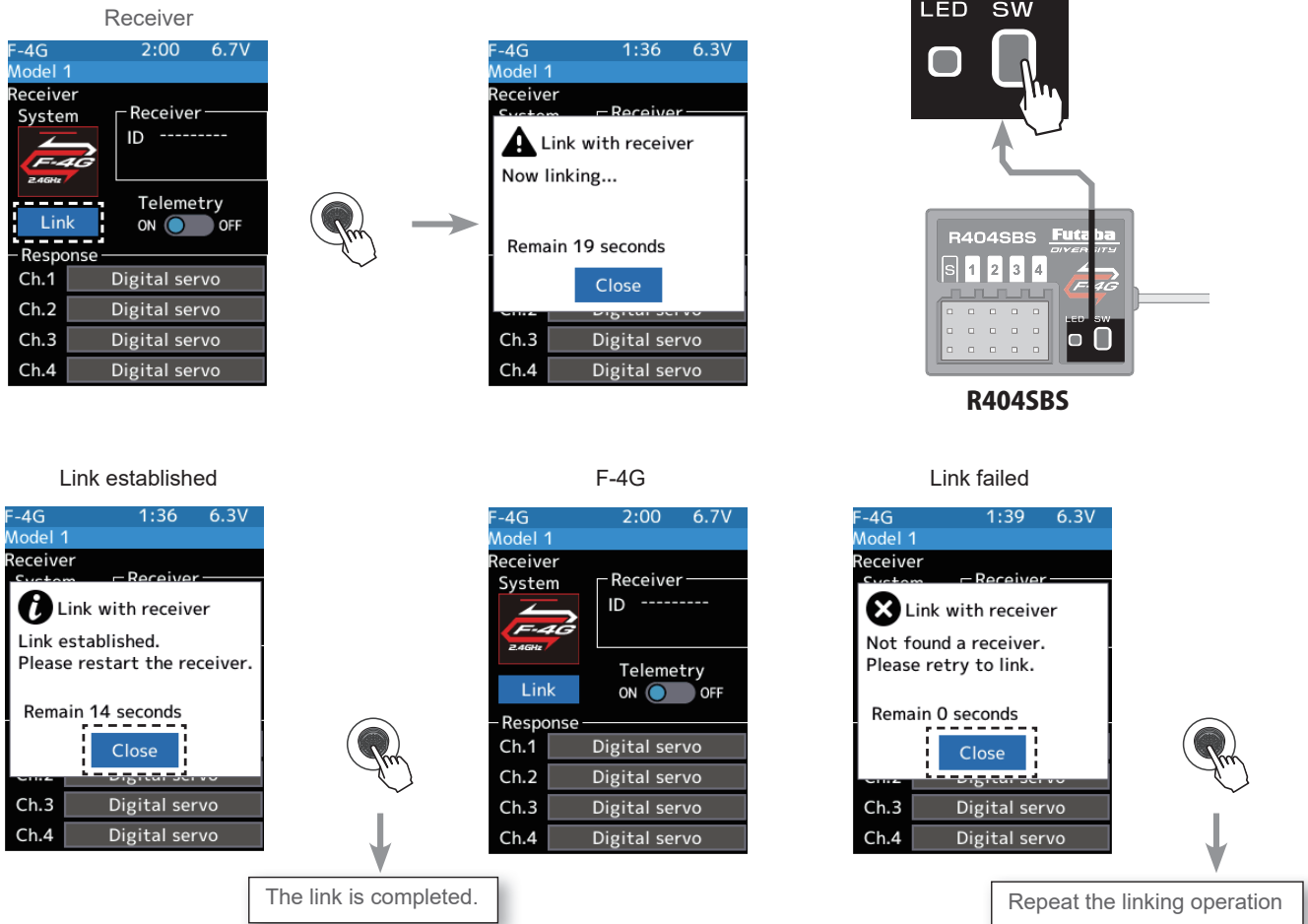

8 Once the settings are complete, turn the receiver off and then on again. The response and battery fail-safe voltage settings will take effect after the receiver is restarted.

*The T6PV and F-4G receiver (R404SBS/R404SBS-E)/T-FHSS receiver memorize the IDs linked last at each model memory. Since only one receiver ID is memorized at each model memory, multiple F-4G/T-FHSS receivers cannot be used with the same model memory. When a receiver at the same model memory is changed, re-linking is necessary even if the receiver is already linked with the transmitter.

*When using multiple F-4G/T-FHSS receivers, link each receiver with each T6PV model memory. However, one receiver can be linked with multiple model memories.

*The telemetry function communication status can be checked at the T6PV home screen.

*For other than F-4G system, the link procedure is different.

Link notice

⚠ WARNING

⊘ Do not perform the linking procedure with motor's main wire connected as it may result in serious injury.

ⓘ After the linking is done, please cycle receiver power and check if the receiver to be linked is really under the control of the transmitter to be linked.

■ The settings will not be reflected unless restart.



LINKAGE MENU

Telemetry function ON/OFF

- 1 (Function ON/OFF)
Use the jog key to select telemetry and use the [+] or [-] button to set it to (ON) or (OFF).

"OFF": Telemetry function OFF
"ON": Telemetry function ON



Setting
- Use the [+] or [-] button to set (ON)/(OFF).

Telemetry function ON

- 2 When finished, return to the Linkage menu screen by pressing the END button, or press and hold the END button to return to the Home screen.

Linking Method For T-FHSS System

Receiver system Change & How To Link

The method of setting up the receiver system and the method of linking the transmitter and receiver are described.

- 1 Set the transmitter "PWR" side power switch to ON. From the Home screen, Operate the jog key in either direction. Next, select [Receiver] at the Linkage menu and access the setup screen shown below by press the jog key.

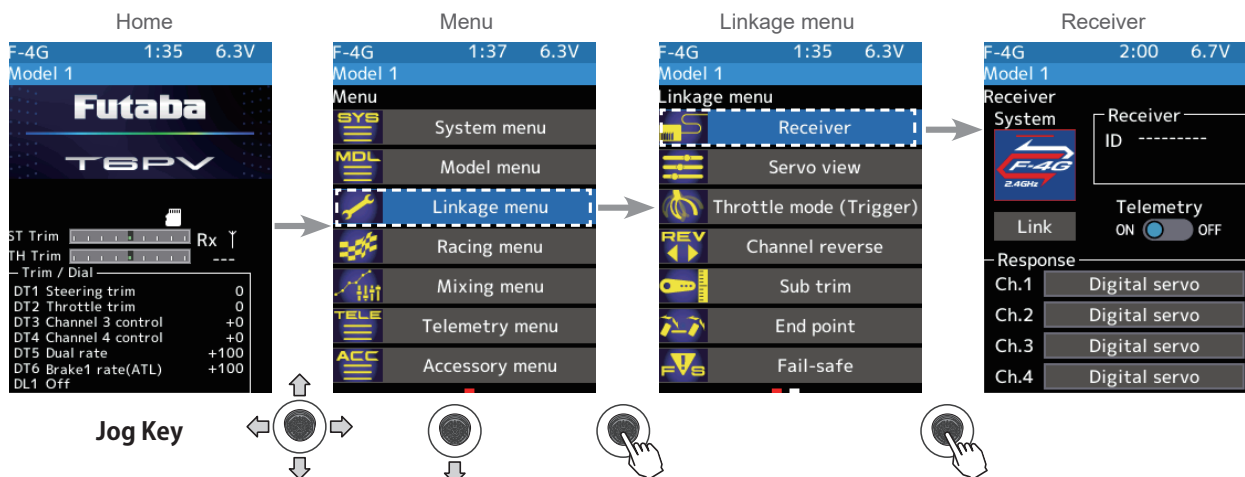



LINKAGE MENU

- In "Receiver", select and press the jog key the [T-FHSS] to be set from systems.

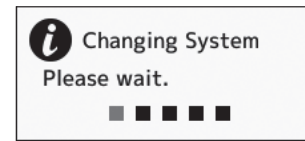
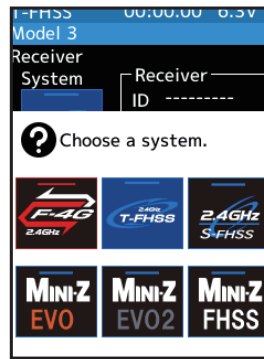

- Bring the transmitter and receiver within 50 cm of each other (antennas do not touch) and turn on the receiver power.
- Select [Link] on the transmitter T6PV screen, you will hear a chime sound and T6PV will enter the link mode for 20 seconds.
- During the 20 seconds link mode, press the receiver push switch for at least 2 seconds. The LED blinks red and then changes to a greenish red → green steady light. When the T6PV makes a beeping sound and the message "Link with receiver" appears on the screen, release the receiver push switch. This ends reading of mutual ID and displays the memorized receiver ID number on the T6PV screen. Power cycle the receiver. If the "Receiver not found" error screen is displayed, linking failed. Check the set contents and repeat the linking operation.

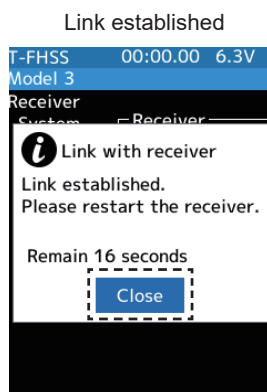
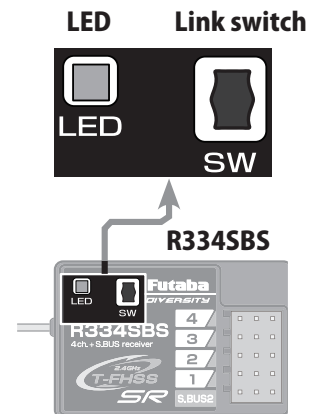
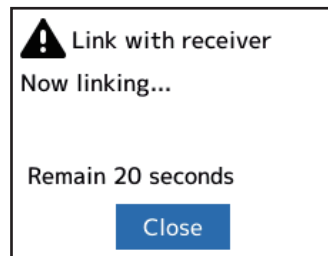

The link is completed.

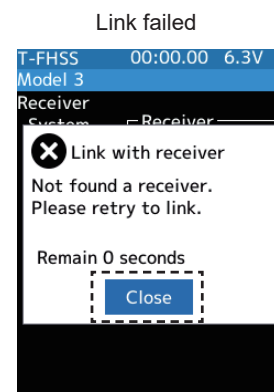

Repeat the linking operation

- Once the settings are complete, turn the receiver off and then on again. The response and battery fail-safe voltage settings will take effect after the receiver is restarted.



LINKAGE MENU

S-FHSS Link

1 Bring the transmitter and the receiver close to each other, within 20 inches (half meter).

2 Turn on the power switch (PWR). On the display (DSP) side, cannot link.

3 Turn on the receiver.

4 Push the push switch of the receiver.

When the link is complete, the LED in the receiver changes to solid green. Check the operation of the servo.

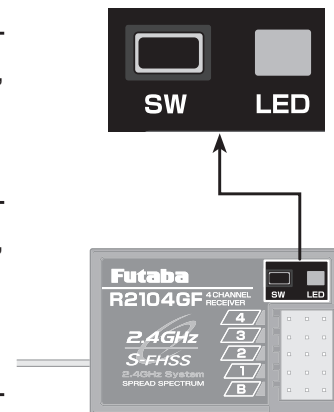

Precaution:

If there are many Futaba 2.4GHz systems turned on close to your receiver might not link to your transmitter. In this case, even if the receiver's LED stays solid green, unfortunately, the receiver might have established a link to one of the other transmitters. It is dangerous if you do not notice this situation. To avoid problems, it is strongly recommended that you double-check that the transmitter controls the receiver by making the wheel or trigger inputs and checking the servo response.

*Please refer to the table below for LED status vs receiver's condition.

LED status vs receiver's condition:

No signal reception	Red: On
Receiving signals	Green: On
Receiving signals, but ID is unmatched.	Green: Blink ^{*1} (T-FHSS, Red: On)
Unrecoverable failure (EEPROM,etc.)	LED: Red and Green turn on alternately

*1: LED could be changed to red during intermittently during data processing.



LINKAGE MENU

Kyosho MINI-Z EVO 82042 (RA-42) Link

- 1 Set the transmitter "PWR" side power switch to ON. From the Home screen, use the jog key to call up the menu. Next, select [Receiver] at the Linkage menu and access the setup screen shown below.

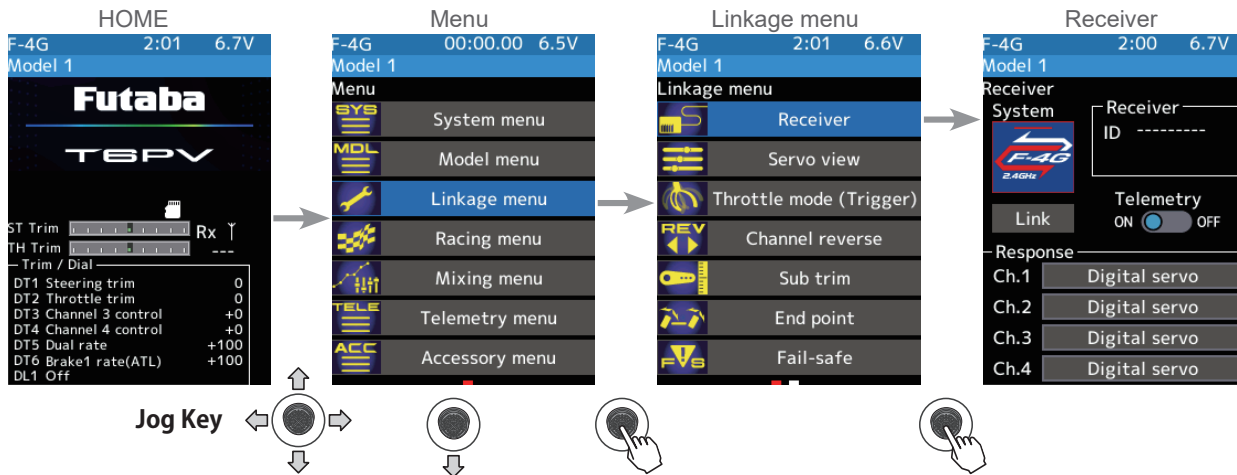

- 2 Display the "Receiver setting" screen from the "Linkage menu". Set the system to "Mini-Z EVO". Bring the transmitter and the receiver close to each other, within 20-inches (half a meter). Turn on the Mini-Z receiver RA-42.

- 3 Use the jog key to select [Link] on the T6PV screen and press it, you will hear a chime sound, and T6PV will enter the link mode for 20-seconds.

- 4 Push the receiver side push switch for about 2-seconds or more.

- 5 Release the Link SW. The LED will solid for 2-seconds and then blink.

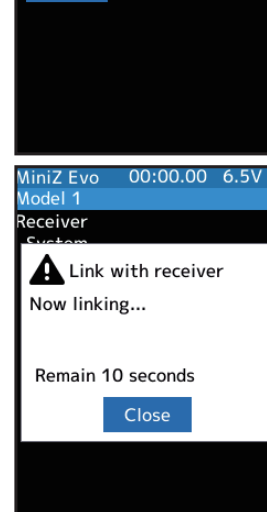
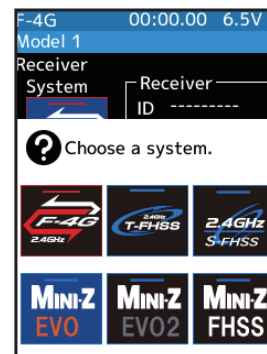

Select [Close] button on the link screen of the transmitter to cancel the link mode.

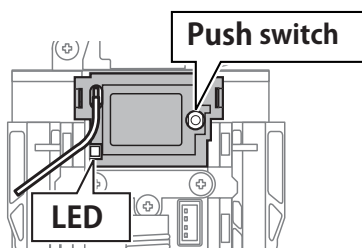

- 6 The LED on the receiver will stay solid, when completed.

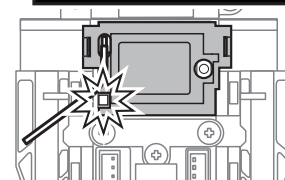



LINKAGE MENU

Kyosho MINI-Z EVO2 82044 (RA-51), 82046(RA-53) Link

* KYOSHO MINI-Z receiver unit **RA-51** [No.82044], **RA-53** [No.82046] (sold separately) is required.

Receiver system Change

- 1 Set the transmitter "PWR" side power switch to ON. From the Home screen, use the jog key to call up the menu. Next, select [Receiver] at the Linkage menu and access the setup screen shown below.

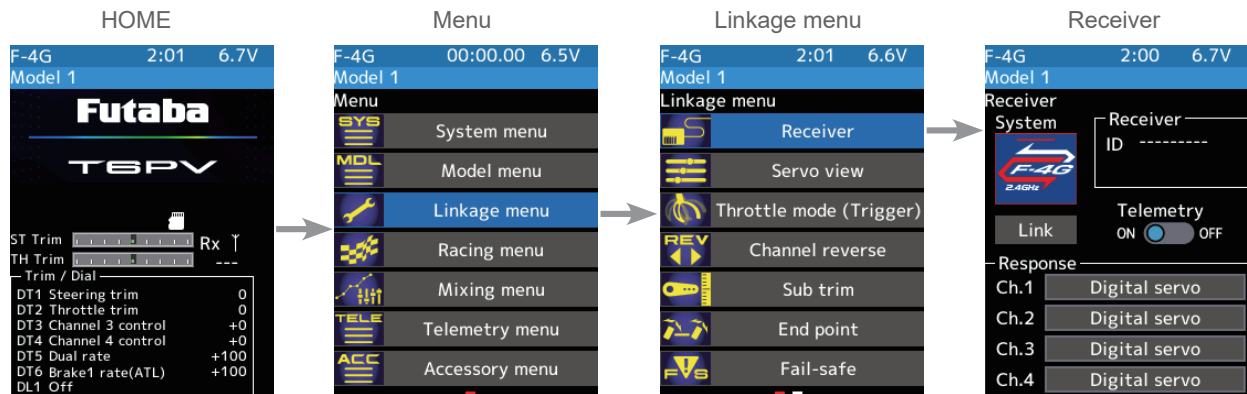

- 2 In "Receiver," select and press jog key the [MINI-Z EVO2].

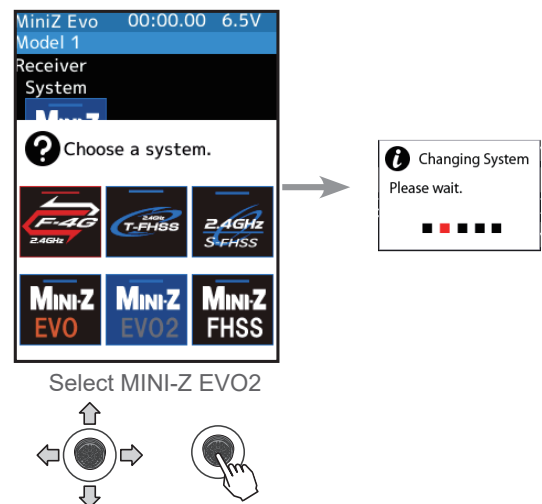

For telemetry receiver unit 82046 (RA-53)

- 3 When using telemetry, use the jog key to move the cursor to the [Bi-Dir] switch and press the [+] or [-] button to turn it ON. A confirmation screen will appear, so press the jog key.





LINKAGE MENU

For telemetry receiver unit 82046 (RA-53)

4 Response is selectable. Use the jog key to move the cursor to [Response] and press it. A selection screen will appear, so use the jog key to select [Slow] or [Fast] and press it.

Response Slow: Telemetry is supported.

Response Fast: Telemetry is not supported.

Both parameter settings from the REAL TIME ICS MiniZ transmitter are supported.

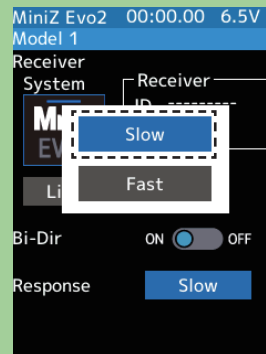

How To Link

With the transmitter T6PV powered on, bring it within 20-inches (half a meter) of the MINI-Z receiver. (Place the antennas as close together as possible.)

- 1 Turn on the power of the MINI-Z receiver.
- 2 Select the [Link] on the “Receiver” screen. The T6PV will enter link mode, and a message will be displayed.
- 3 Press and release the link switch on the MINI-Z receiver for more than 2 seconds, and when the LED lights up for 2 seconds and then flashes again, cancel the link mode of the T6PV and return it to normal mode.
- 4 When the MINI-Z receiver LED lights up, the link is complete.

* 82042 and 82044 do not show a link OK message.

82046 shows a message when the MINI-Z EVO/MINI-Z EVO2 link is successful. Also, when MiniZ-EVO2 is bidirectionally ON, the ID is displayed when the link is successful.

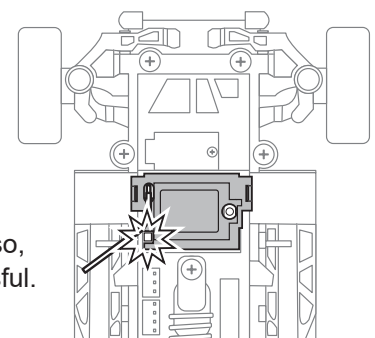
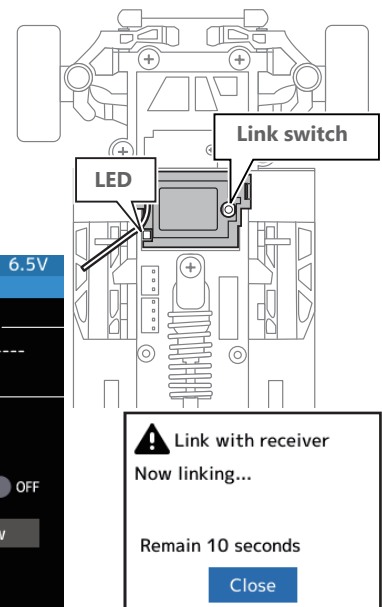

⚠ Warning

❗ After the linking is done, please cycle receiver power and check if the receiver to be linked is really under the control of your transmitter.

In this case, even if the receiver's LED stays solid green, unfortunately, the receiver might have established a link to one of the other transmitters. This is very dangerous if you do not notice this situation. In order to avoid the problem, we strongly recommend you to double-check whether your receiver is really under control by your transmitter by giving the stick input and then checking the servo response.

❗ Do not perform the linking procedure with the motor's main wire connected or the engine operating as it may result in serious injury.



LINKAGE MENU

● Supported the following Kyosho products:

Compatible receivers

MINI-Z EVO receiver unit T7PX/T7XC/T4PM 82042

MINI-Z EVO2 receiver unit for Futaba compatible transmitters 82044

MINI-Z EVO2 receiver unit V2 for Futaba compatible transmitters 82046

Compatible chassis

MR-03EVO

MINI-Z racer MR-03 EVO chassis set (W-MM/12000KV) 32790

MINI-Z racer MR-03 EVO chassis set (N-MM2/5600KV) 32791

MR-04 EVO2

MINI-Z racer MR-04 EVO2 chassis set (W-MM/8500KV) 32890

MINI-Z racer MR-04 EVO2 chassis set (W-MM/5600KV) 32891

MINI-Z racer MR-04 EVO2 chassis set (N-MM2/4100KV) 32892

MINI-Z EVO is a non-telemetry protocol compatible with the MR-03 EVO chassis.

Compatible chassis

MINI-Z racer MR-03EVO chassis set (W-MM/12000KV) 32790

MINI-Z racer MR-03EVO chassis set (N-MM2/5600KV) 32791

Compatible receivers

FUTABA/FHSS receiver unit (for T7PX/T7XC) No82042

MINI-Z EVO2 receiver unit for Futaba compatible transmitters 82044

MINI-Z EVO2 receiver unit V2 for Futaba compatible transmitters 82046

MINI-Z EVO2 is a protocol compatible with the MR-04 EVO2 chassis.

MINI-Z racer MR-04 EVO2 chassis set (W-MM/8500KV) 32890

MINI-Z racer MR-04 EVO2 chassis set (W-MM/5600KV) 32891

MINI-Z racer MR-04 EVO2 chassis set (N-MM2/4100KV) 32892

MINI-Z EVO2 telemetry OFF is a non-telemetry protocol.

MINI-Z EVO2 receiver unit for Futaba compatible transmitters 82044

MINI-Z EVO2 receiver unit V2 for Futaba compatible transmitters 82046

MINI-Z EVO2 telemetry ON has two types of telemetry protocols.

Response Slow ···· REAL TIME ICS MiniZ and Telemetry Enabled

Response Fast ······ REAL TIME ICS MiniZ (non-telemetry)

MINI-Z EVO2 receiver unit V2 for Futaba compatible transmitters 82046

	MR-03 EVO	MR-04 EVO2
82042	○ (Link with MINI-Z EVO)	○ (Link with MINI-Z EVO)
82044	○ (Link with MINI-Z EVO)	○ (Link with MINI-Z EVO or MINI-Z EVO2 telemetry OFF)
82046	○ (Link with MINI-Z EVO)	○ (Link with MINI-Z EVO or MINI-Z EVO2 telemetry OFF or MINI-Z EVO2 telemetry ON)



LINKAGE MENU

Kyosho MINI-Z FS-RM005 module Link

* KYOSHO MINI-Z module FS-RM005 is required.

Receiver system Change

Connect FS-RM005 module to T6PV.

- 1 Set the transmitter "PWR" side power switch to ON. From the Home screen, use the jog key to call up the menu. Next, select [Receiver] at the Linkage menu and access the setup screen shown below.

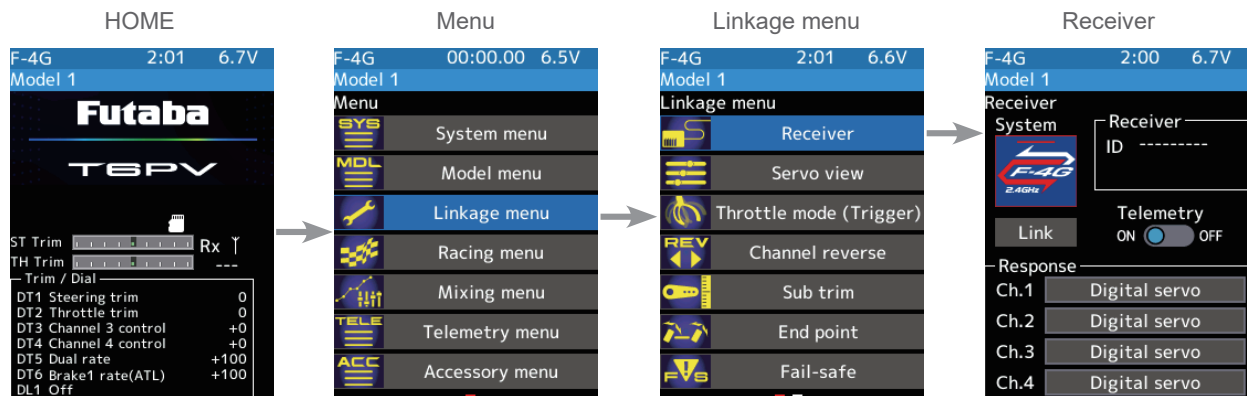

- 2 In "Receiver," select and press jog key the [MINI-Z FHSS].

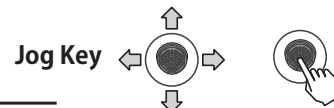
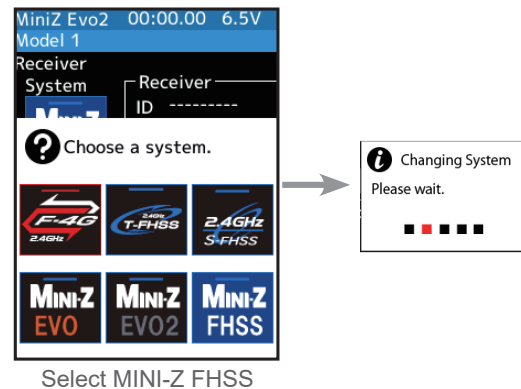

- 3 System change ends. After changing the system, be sure to link it with the Receiver.

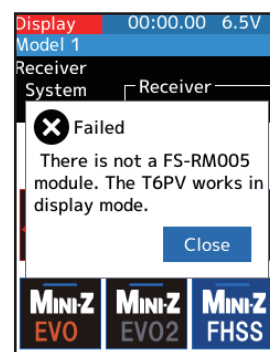

If the FS-RM005 module is not connected to the transmitter, an error message will appear. Connect the FS-RM005 module.



LINKAGE MENU

How To Link

With the transmitter T6PV powered on, bring it within 20-inches (half a meter) of the MINI-Z receiver.

1 Turn on the power while pressing the link switch of the MINI-Z receiver. Check that the LED on the MINI-Z receiver blinks quickly and releases the link switch.

2 Select the [Link] on the "Receiver" screen. The T6PV will enter link mode, and a message will be displayed. Confirm that the LED on the MINI-Z receiver has changed to slow blinking, then Select the [Close].

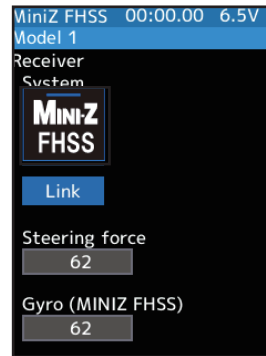

3 Linking is complete when the LED on the MINI-Z receiver changes from blinking to lit.

MINI-Z FHSS receiver function setting method

You can set the steering force function and gyro function of the MINI-Z FHSS receiver with T6PV.

1 (Steering force adjustment)
Select the value with jog key of [Steering force]. Use the [+] or [-] button to adjust the steering force amount.

(Gyro gain adjustment)

Select the value with jog key of [Gyro (MINIZ FHSS)]. Use the [+] or [-] button to adjust the gyro gain amount.

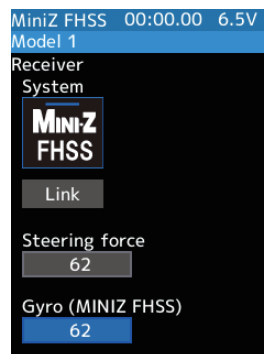
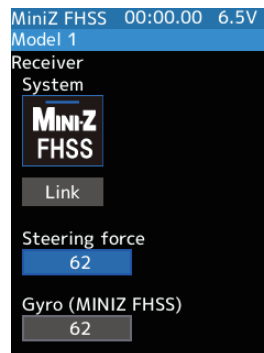

Adjustment buttons

- Adjust with the [+] or [-] button.
- Return to the initial value by press the [+] and [-] button simultaneously

Steering force

1~100
Initial value: 62

Gyro gain

1~100
Initial value: 62

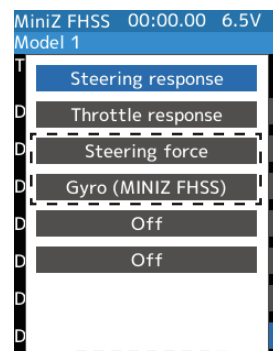

Trim/Dial Setting

The Steering force amount and Gyro gain can be controlled with the digital dial or digital trim using the trim/dial select function. (Linkage menu)



LINKAGE MENU



Servo view

The servo operation of each channel can be checked. Process of the steering angle adjustment, when a mixing function was set, etc. can easily confirm it.

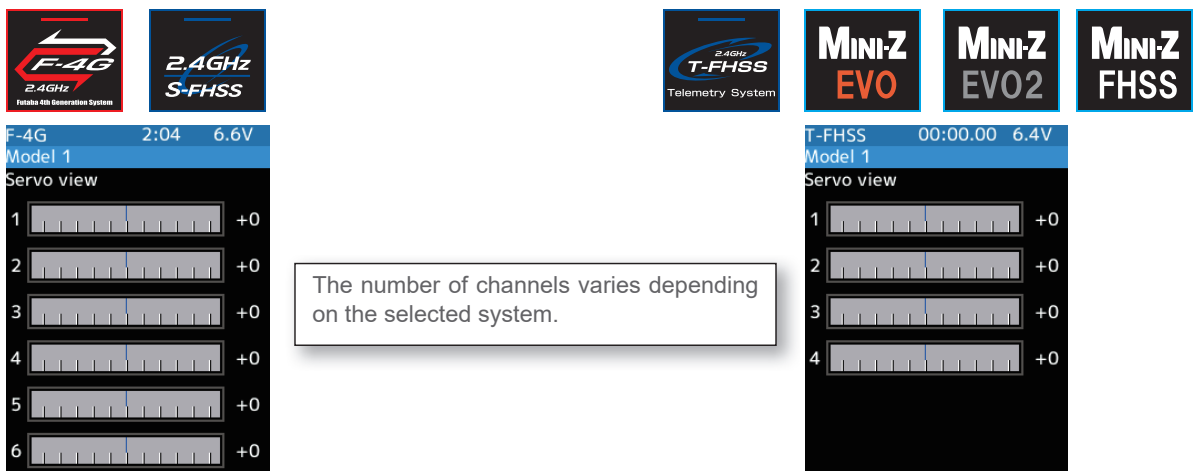
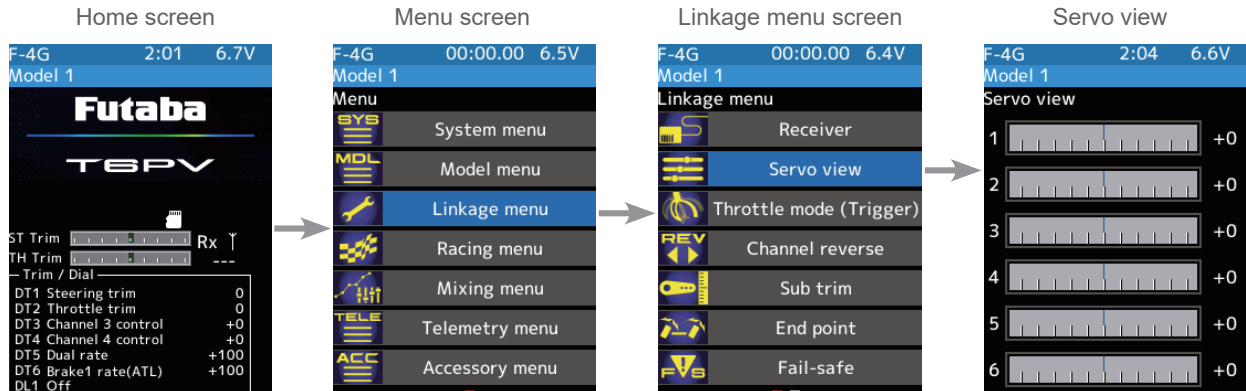

Confirm operation

- 1 Operating each channel, such as a steering wheel or throttle trigger, the graph moves, and the servo operation can be confirmed.
- 2 When finished, return to the Linkage menu screen by pressing the END button, or press and hold the END button to return to the Home screen.



LINKAGE MENU



Throttle mode (Trigger)

This menu has the following two functions:

-Servo neutral mode:

This function allows the selection of the forward side and brake (reverse) side operation ratio from 70:30, 60:40, 50:50, or 100:0 by changing the neutral position of the throttle servo.

-Neutral brake:

To use the "Neutral brake" function, switch set by the "Switch select" function (Linkage menu) is necessary. The neutral brake, which applies the brakes at the neutral position of the throttle trigger, can be set. However, when using the MC971CR, MC970CR, MC960CR, MC950CR, MC851C, MC602C, MC402CR, or other Futaba ESC, confirm that the ESC is in the neutral position and the set is in the operation mode before setting the neutral brake function switch to ON.

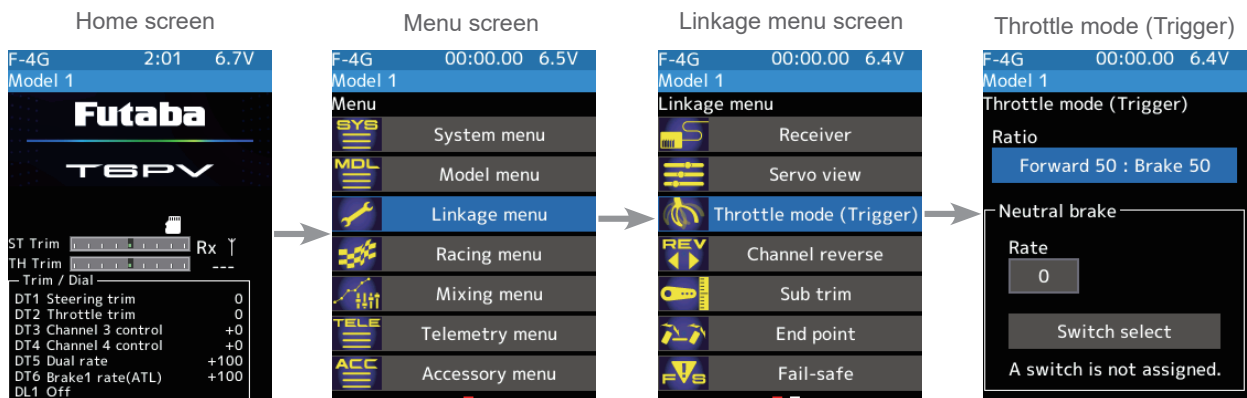

Throttle servo neutral position "Ratio"

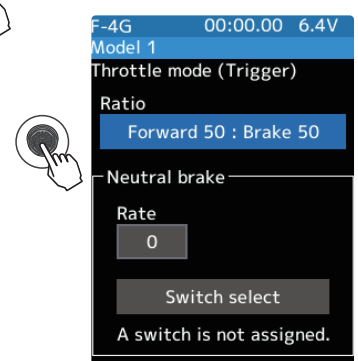
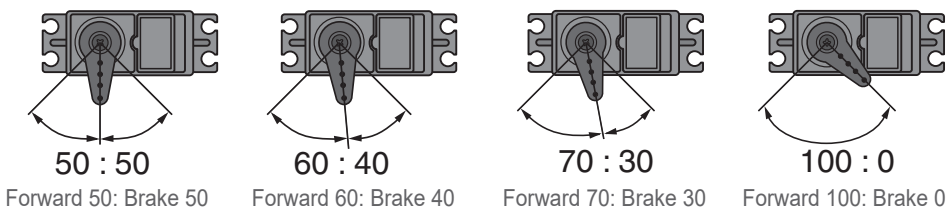

Selecting the trigger ratio

1 (Throttle mode selection)

- Select [Ratio] part.

The mode list appears on the Throttle mode (Trigger) menu screen.

Press jog key from the list and select the mode.

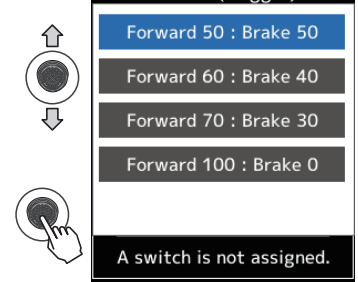

2 When finished, return to the Linkage menu screen by pressing the END button, or press and hold the END button to return to the Home screen.



LINKAGE MENU

Neutral brake "Rate"

Neutral Brake function adjustment

(Preparation)

- Use the switch select function to the "Switch select".

When the switch is not set, "A switch is not assigned" is displayed. Select the [Switch select] to display the switch selection screen and set the switch.

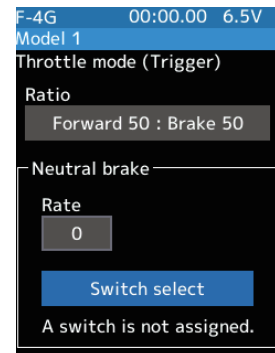

Adjust button

Adjust with the [+] or [-] button.
- Return to the initial value by press the [+] and [-] button simultaneously

Neutral Brake

0~100
Initial value: 0

1 (Neutral brake rate)

Select the value with jog key of the [Rate]. Use the [+] or [-] button to adjust the neutral brake rate amount.

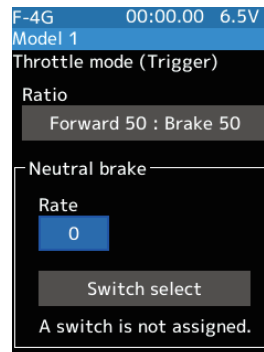

2 When finished, return to the Linkage menu screen by pressing the END button, or press and hold the END button to return to the Home screen.

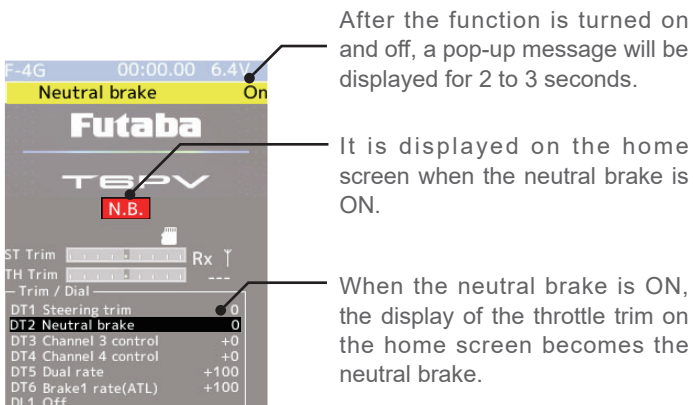

After the function is turned on and off, a pop-up message will be displayed for 2 to 3 seconds.

It is displayed on the home screen when the neutral brake is ON.

When the neutral brake is ON, the display of the throttle trim on the home screen becomes the neutral brake.

If the power switch is turned on while the neutral brake switch is on, an audible alarm will be heard. Immediately set the neutral brake switch to OFF.

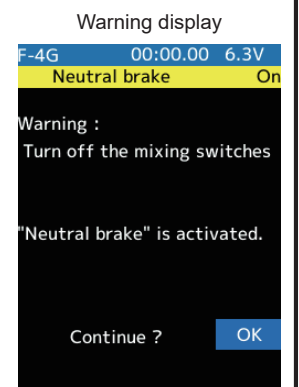

Reference

The ESC neutral brake function and the T6PV neutral brake function can be used simultaneously. However, when the setting is difficult to understand, we recommend that only one neutral brake function be used.

Trim/Dial Setting

When the neutral brake function is "ON", the neutral brake rate adjustment is automatically assigned to the throttle trim (DT1 to DT6 or DL1).

Effect of set value of other functions on the neutral brake

Throttle side EPA function, or ATL function setting also affects neutral brake side operation. The Idle-up or Engine Cut function has priority.



LINKAGE MENU



Channel reverse

This function reverses the direction of operation of the servos related to transmitter steering, throttle, channel 3-6 channels operation.

However, when the position set by trim or sub trim shifts from the center, the center becomes the opposite side.

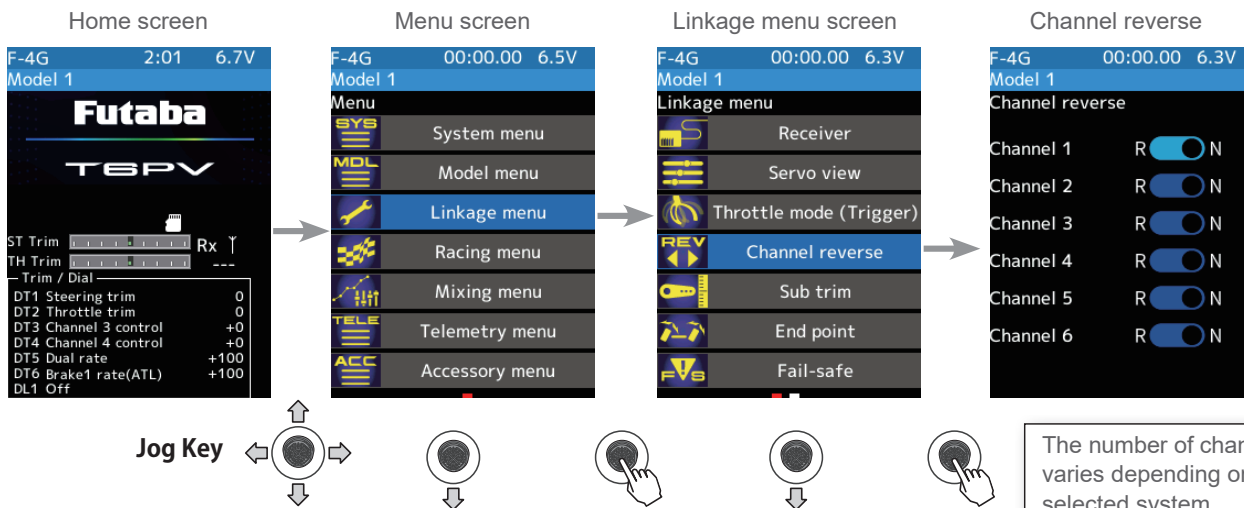

Servo Reverse Function Setting

- 1 (Channel Settings)**
Use the jog key to select the servo channel to be set.



Setting
- Press [+] or [-] button
(N) Normal/(R) Reverse

- 2 (Servo reverse setting)**
Use the [+] or [-] button to set N: normal or R: reverse.
(Each channel can be set similarly.)



- 3** When finished, return to the Linkage menu screen by pressing the END button, or press and hold the END button to return to the Home screen.



LINKAGE MENU



Sub trim

Use this function to adjust the neutral position of the steering, throttle, channel 3, channel 4, and auxiliary channels servos.

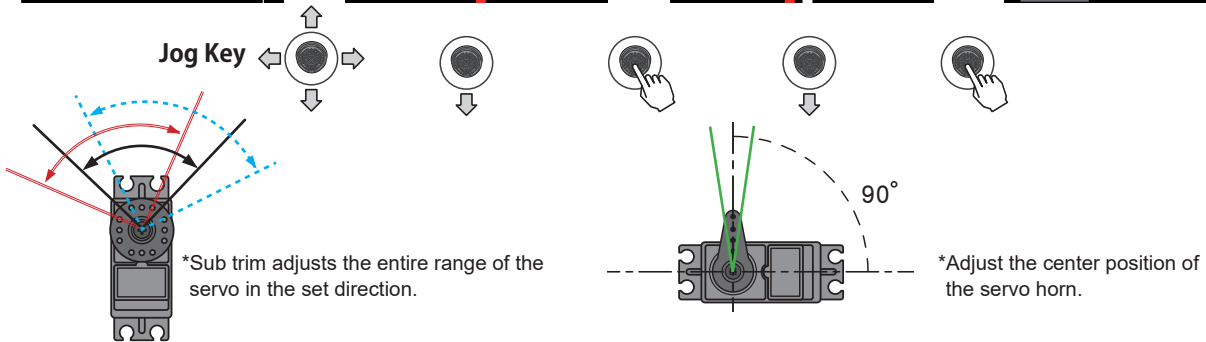
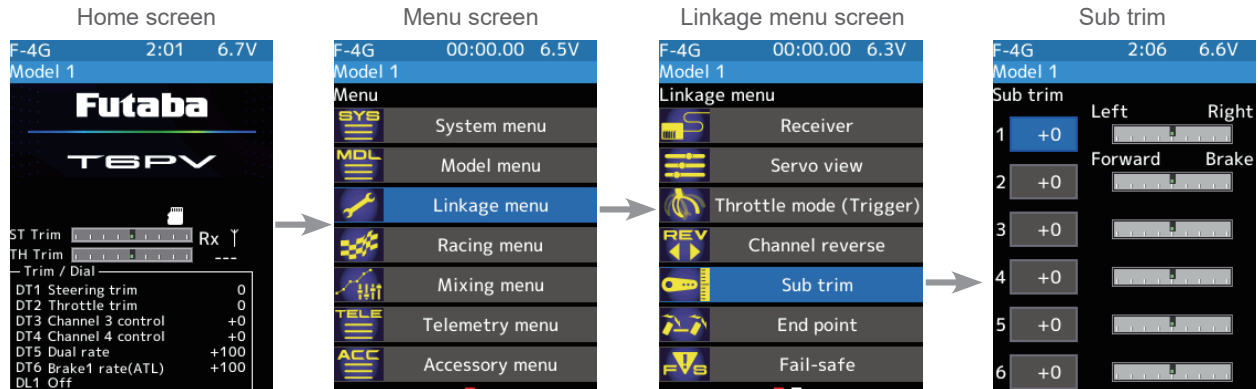

Sub trim adjustment

(Preparation)

- Follow the instructions of the model, install the servo horn, and make the next adjustment.
- Set the steering and throttle digital trims to the neutral "0" position. Set auxiliary channels to the center "0" position.
- Use the jog key to move the cursor to the numerical portion of the channel to be set.

Adjustment buttons

- Adjust with the [+] or [-] button.
- Return to the initial value by press the [+] and [-] button simultaneously

Sub trim

-100~+100
Initial value: 0

1 (Sub trim adjustment)

Use the [+] or [-] button to adjust the center.

- Sub trim adjustment value ± 100 corresponds to approximately 20% of the actual steering angle.
- If the sub trim adjustment value becomes larger, adjust the servo horn mounting angle and hole position and try again.

(Each channel can be set similarly.)

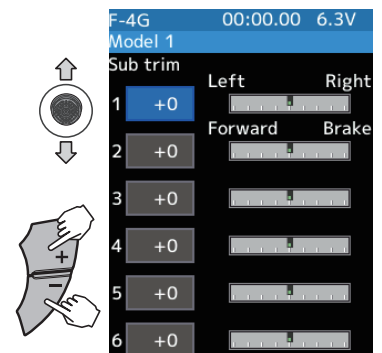

- When finished, return to the Linkage menu screen by pressing the END button, or press and hold the END button to return to the Home screen.



LINKAGE MENU



End point

Used to adjust the left and right end points of the steering wheel, adjust the throttle high side/brake side manipulated variable, change the channel 3, channel 4, auxiliary channel servo upside/downside manipulated variable.

- Correct the maximum steering angle for left and right steering angles when there is a difference in the turning radius due to the characteristics of the vehicle.

Maximum steering angle

The End point function determines the maximum steering angle of each channel. The functions shown below may have been adjusted, or the operating range set by End point function may be exceeded. Check the linkage each time the following functions are adjusted.

- Sub trim (all channels)
- Program mixing slave side (all channels)
- Idle up (throttle)
- Engine Cut (throttle)

Brake rate trim

Brake rate trim allows adjustment of the brake side operation amount during operation. Therefore, when the operating angle is adjusted with the throttle End point, the brake rate trim must also be taken into account.

⚠ Warning

❗ Operate each servo over its full stroke and be sure the linkage does not bind or is not loose.

The continuous application of unreasonable force to a servo may cause damage and excessive battery drain.

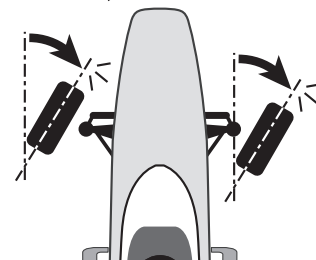
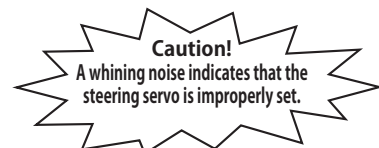

Decide the End point value at the contact point.

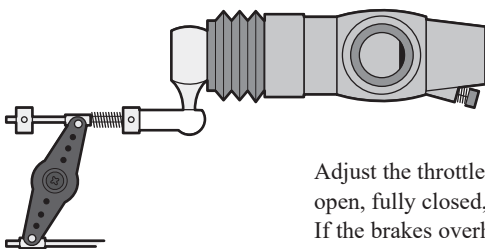

Adjust the steering servo so that unreasonable force is not applied to the servo by the chassis at maximum servo travel.

Adjust the throttle servo so that unreasonable force is not applied when the engine carburetor is fully open, fully closed, and the brakes are implemented fully. If the brakes overheat while running, their ability to function correctly decreases. Before running, adjust the suitable maximum servo travel so that unreasonable force is not applied even when the servo travel is increased while running.



LINKAGE MENU

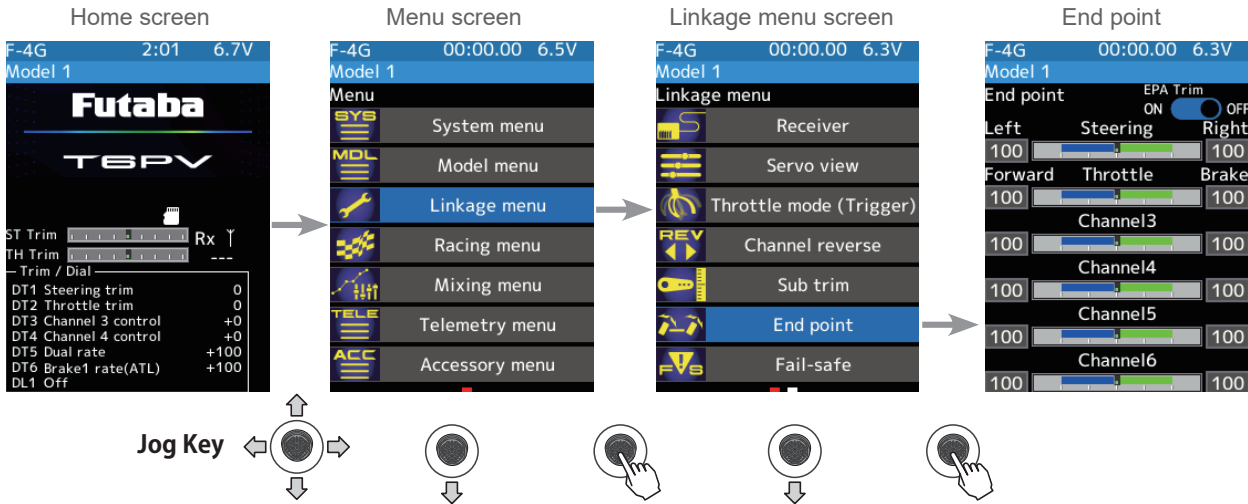

Steering end point adjustment

(Preparation)

- Before setup of the steering end point adjustment, set the steering D/R dial (initial setup: DT5) to the maximum steering angle position 100%.
- Use the jog key to move the cursor to the steering setting value:

1 Steering (left side) adjustment.

Turn the steering wheel entirely to the left and use the [+] or [-] button to adjust the steering angle.

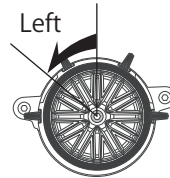

2 Steering (right side) adjustment.

Turn the steering wheel entirely to the right and use the [+] or [-] button to adjust the steering angle.

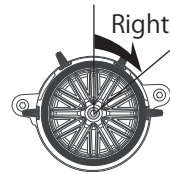

Note

Step #1 & #2 are done when the receiver is in the on position installed on the chassis. You're watching the wheels reach their maximum end point.

- When finished, return to the Linkage menu screen by pressing the END button, or press and hold the END button to return to the Home screen.



Quick EPA

When EPA trim is turned on, the steering angle (end point) can be adjusted by steering trim set digital trim or dial. (Steering trim initial setting: DT1)

-Steering left side adjustment

With the steering wheel turned fully to the left, steering is adjusted by steering trim and temporarily displayed at this part of the HOME screen, as shown in the figure below.

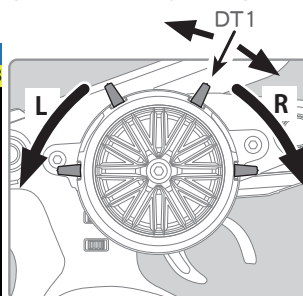
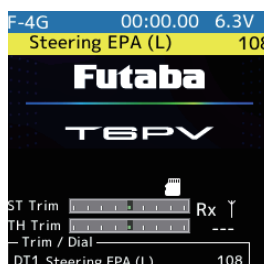

-Steering right side adjustment

With the steering wheel turned fully to the right, steering is adjusted by steering trim and temporarily displayed at this part of the HOME screen, as shown in the figure below.

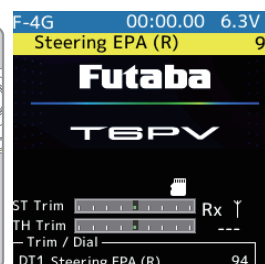



LINKAGE MENU

Throttle end point adjustment

(Preparation)

- Before setting the throttle end point adjustment, set the throttle ATL dial (initial setup: DT6) to the maximum throttle angle position 100%.
- Use the jog key to move the cursor to the throttle setting value:

Adjustment buttons

- Use the [+] or [-] button to make adjustments.
- Return to the initial value by press the [+] and [-] button simultaneously

Throttle End point: 0~140
Initial value: 100

1 Throttle (forward side) adjustment
Pull the throttle trigger fully to the high side and use the [+] or [-] button to adjust the throttle angle. However, when using an ESC, set to 100%.

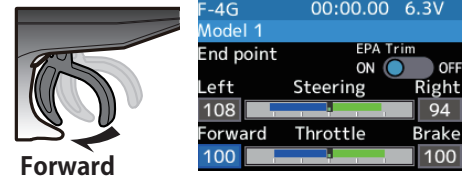

2 Throttle (brake side/reverse side) adjustment
Move the throttle trigger fully to the brake side and use the [+] or [-] button to adjust the throttle angle. However, when using an ESC, set to 100%.

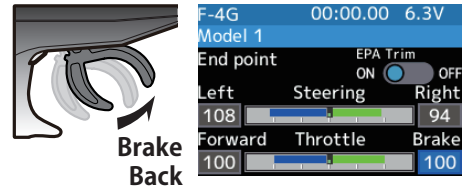

3 When finished, return to the Linkage menu screen by pressing the END button, or press and hold the END button to return to the Home screen.

When trigger ratio (Linkage menu → Throttle mode) was set to 100:0, brake operation is stopped and the throttle (brake side) cannot be adjusted.

Auxiliary channel servo end point adjustment

(Preparation)

- Press jog key the travel button of the channel you want to set. Use the [+] or [-] button to set the rate.

Adjustment buttons

- Use the [+] or [-] button to make adjustments.
- Return to the initial value by press the [+] and [-] button simultaneously

1 Use the [+] or [-] button to adjust the servo angle.

Auxiliary channel End point :0~140
Initial value: 100

Spare channel display

When a mixing function is set at a spare channel, the display changes.

This is an example of setting dual ESC mixing at the 3rd channel and 4WS mixing at the 4th channel.

Dual ESC mixing: Front ESC →
4WS mixing: Rear servo →

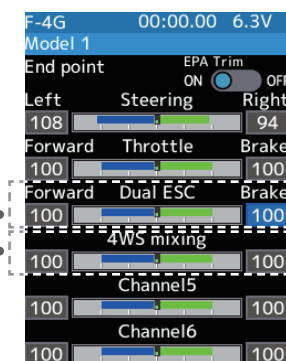

2 When finished, return to the Linkage menu screen by pressing the END button, or press and hold the END button to return to the Home screen.



LINKAGE MENU



Fail-safe/Battery fail-safe

This function sets the servo operation position when transmitter signals cannot be received by the receiver for some reason, or the battery voltage has dropped.

-Fail-safe mode

This function moves each servo to a preset position when the receiver cannot receive the signals from the transmitter for some reason.

* The fail-safe data is transferred from the transmitter to the receiver 10-seconds after the transmitter power was turned on.

* **Note:** Normally, the transmitter is turned on before the receiver, so the receiver will not receive data for about 10-seconds after the receiver is turned on.

* For gasoline engine cars, for safety, we recommend that this fail-safe function be used to set the throttle channel in the direction in which the brakes are applied.

-Hold mode

This function holds the receiver in its position immediately before the reception was lost.

-Off mode (OFF)

This function stops the output of signals to the servos and places the servos into the free state when the receiver cannot receive it.

The F/S, HOLD, and OFF modes are automatically reset when signals from the transmitter can be received again.

For F-4G, CH5 and CH6 cannot be set to Off mode.

-Battery fail-safe function (B-F/S)

If the receiver battery voltage drops below a specific value when this function is enabled, the throttle servo moves to the position set by fail-safe function. When the battery voltage recovers, the battery fail-safe function is automatically reset.

* This function cannot be used when the channel is not set to fail-safe.

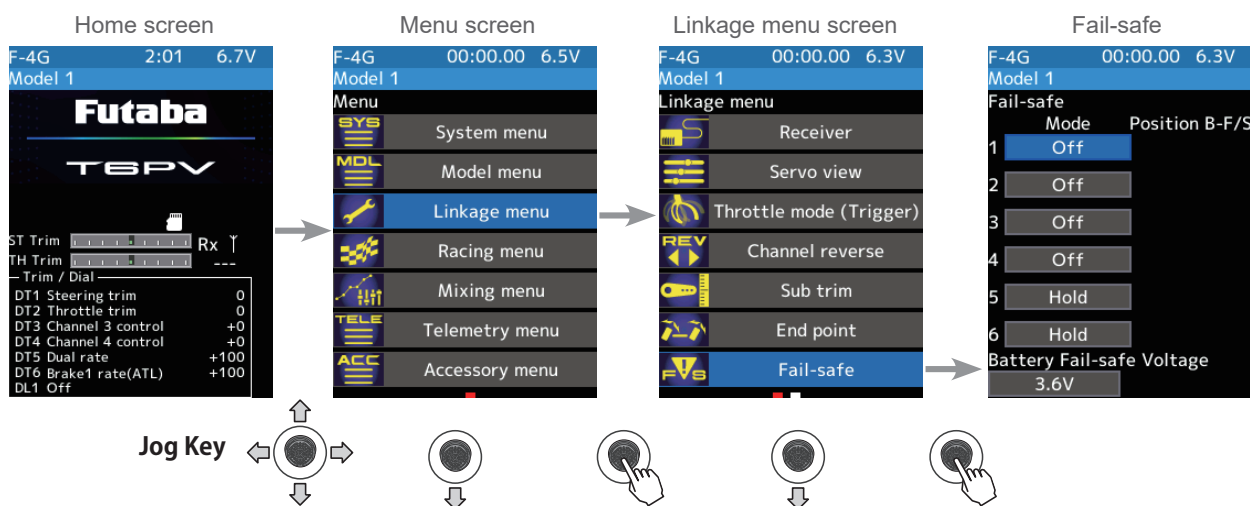

* When fail-safe is set, that servo position is displayed.

Servo position



LINKAGE MENU

Fail-safe mode selection

(Preparation)

- Use the jog key to select the fail-safe channel you want to set.

1 (Mode selection)

Use the [+] or [-] button to select from Off-Fail-safe-Hold.

(Each channel can be individually set.)

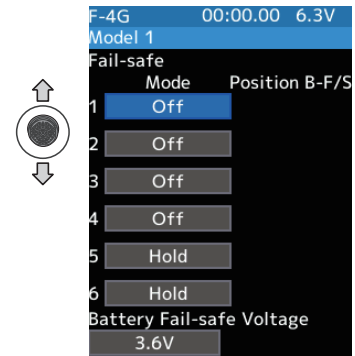

Fail-safe mode
Off, Hold, Fail-safe

- When finished with Hold mode or Off mode setting, return to the Linkage menu screen by pressing the END button, or press and hold the END button to return to the Home screen. When setting fail-safe, set the servo position by the following method.

Fail-safe function setup

1 (Servo position setup)

Select [Mode] button of the channel you want to set, and set that channel to the Fail-safe mode. Use the jog key to move the cursor to [Position].

Hold the corresponding steering wheel, throttle trigger, or other control in the position you want the servo to move to when the fail-safe function is activated, and press the jog key.

The position is displayed as a value.

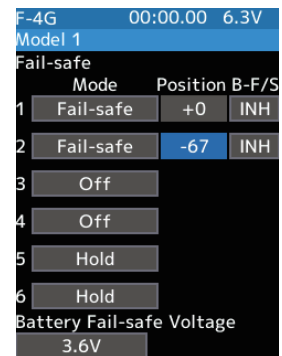

Fail-Safe position setting

While holding the wheel or trigger in the fail-safe position, press the jog key.

- When finished, return to the Linkage menu screen by pressing the END button, or press and hold the END button to return to the Home screen.

B-F/S function ON/OFF & Battery Fail-safe voltage setting

1 (Battery fail-safe function ON/OFF)

Use the jog key to move the cursor to the setting channel B-F/S and press the [+] or [-] button to set it to ON/OFF.

2 (Battery fail-safe voltage setting)

Use the jog key to move the cursor to the battery fail-safe voltage and use the [+] or [-] button to set the voltage.

* The voltage setting is not possible with the S - FHSS system fixed at 3.8 V.

- When finished, return to the Linkage menu screen by pressing the END button, or press and hold the END button to return to the Home screen.

* For the F-4G, the battery fail-safe voltage is set in the receiver when linking. If you change the battery fail-safe voltage setting, the message [Please link the receiver] will appear, so bring the receiver closer, turn it on, select [Link] on the screen with the jog key, press it, and press the receiver switch to link again.

Battery fail-safe function

OFF, ON
Initial value: OFF

Battery Fail-safe Voltage

F-4G
3.5 V-8.6 V
T-FHSS
3.8,4.0,4.2,4.4,4.6,4.8,5.0,
5.3,5.6,5.9,6.2,6.5,6.8,7.1,7.4V
S-FHSS
Only 3.8V

Example:

Ni-MH/Ni-Cd: 4cell---3.8V
Ni-MH/Ni-Cd: 6cell---4.4V
LiFe: 2cell---4.75/4.8V
Li-Po: 2cell---5.5/5.6V

When the receiver power supply of an electric car uses a common power supply from an ESC, we recommend that this function be set to OFF because the voltage supplied to the receiver may drop momentarily and the battery fail-safe function may be activated.



LINKAGE MENU



Acceleration

The servo will jump to the input position at its maximum possible speed. Unlike exponential, which adjusts the whole throttle movement into a curve, throttle acceleration "jumps" away from neutral and then leaves the remaining response linear.

Operation

- Operation near the throttle trigger neutral position becomes a sharp rise.
- The forward and brake sides can be set separately.
- When the brake mixing function (Mixing menu) is set, the auxiliary channel brake can also be set.

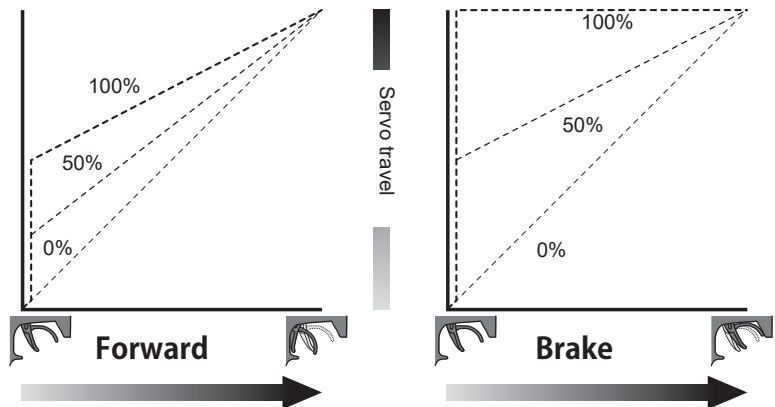

Set value

The standard value (100% point) of this setup affects the operation amount set by the throttle end point function.

Convenient usage method

For gasoline engine cars, the linkage must have clearance because one servo controls the engine carburetor and brake. Thus, there is a noticeable time delay at both the forward and brake sides. Sharp response comparable to that of electric motor cars is obtained by reducing this clearance at the transmitter side.

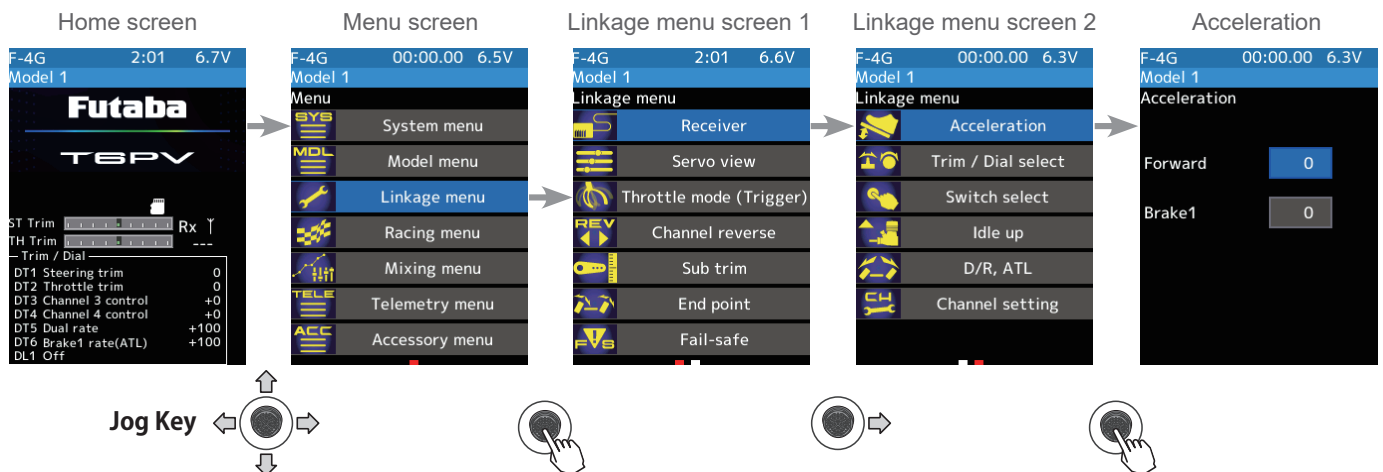
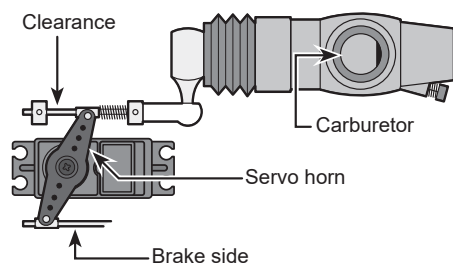



LINKAGE MENU

Throttle acceleration adjustment

(Preparation)

- Use the jog key to move the cursor to the forward value:

- 1 (Forward acceleration amount adjustment)
Use the [+] or [-] button to adjust the acceleration amount.

"0" :No acceleration

"100" :Maximum acceleration (Approximately 1/2 of the forward side throttle angle)

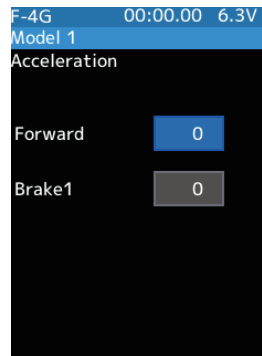

Adjustment buttons

Adjust with the [+] or [-] button.
- Return to the initial value by press the [+] and [-] button simultaneously

Forward acceleration amount (Forward)

0~100

Initial value: 0

Brake side acceleration amount (Brake1)

0~100

Initial value: 0

- 2 (Brake side acceleration amount adjustment)
Press jog key the travel button of the [Brake 1]. Use the [+] or [-] button to adjust the acceleration amount.

"0" :No acceleration

"100" :Maximum acceleration (Brake side maximum throttle angle)

If the "Brake Mixing Function" is being set, the auxiliary channel brake side acceleration will become adjustable.

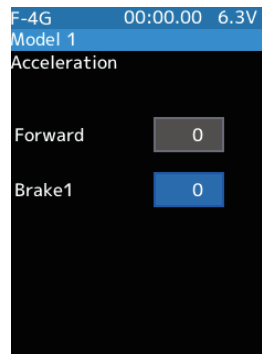

Brake 2

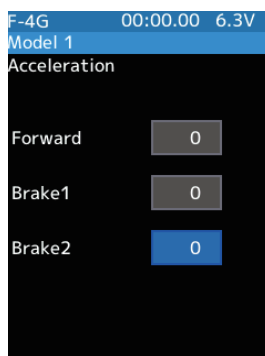

Brake 3

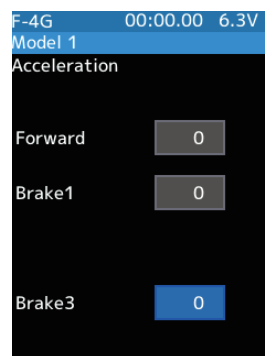

Brake 2&3

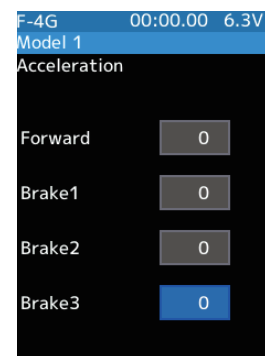

- 3 When finished, return to the Linkage menu screen by pressing the END button, or press and hold the END button to return to the Home screen.

Caution

When the trigger ratio (Linkage menu→Throttle mode) was set to 100:0, brake operation is stopped, and the throttle (brake side) cannot be adjusted.

Trim/Dial Setting

The throttle acceleration adjustment amount (Forward), (Brake 1), auxiliary channels (Brake 2, Brake 3) can be controlled with digital trim DT1-DT6 or digital dial DL1, etc. with the trim/dial select function.

LINKAGE MENU



Trim/Dial select

This function allows the selection of the function performed by the digital dial DL1 and digital trimmers (DT1 to DT6), step amount adjustment, and operating direction reversal.

- The table on next page lists the functions that can be assigned to each dial and digital trim. The assigned function is also displayed on the opening screen together with the current adjustment value. They are displayed in DL1 and DT1 to DT6 order, from top to bottom.
- The step amount can be adjusted. The table in the following page shows the relationship between the set value and step amount.
- The operation direction can be reversed. (Nor./Rev.)

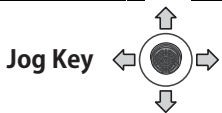
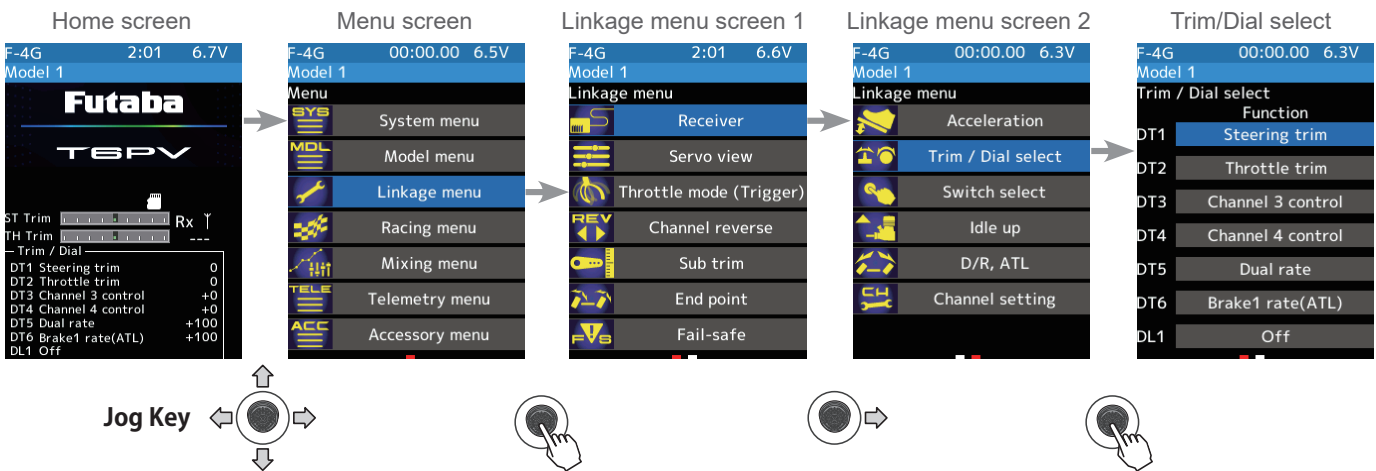

The screen display

When the trim or the dial is adjusted, the value of the function is displayed for a few seconds at the top of the screen.

Example:

The trim/dial is assigned to the gyro mixing function.

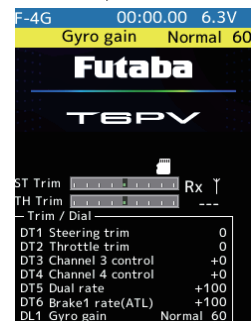

The value of the gyro gain is indicated to the top of the screen for several seconds.

Function select dial setup

- 1 Use the jog key to move the cursor to the trim or dial you want to set.
(DT1, 2, 3, 4, 5, 6/DL1)
- 2 When the cursor is on the desired trim or dial, press the jog key. The function list appears on the Trim/Dial select menu screen.
- 3 (Function setup)
Use the jog key to select a function and press it.

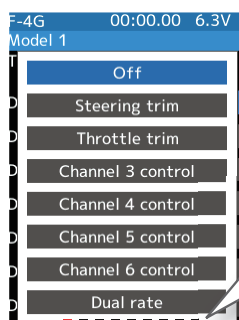
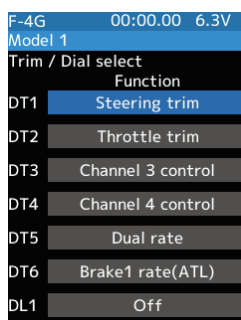

Use the jog key left and right to move between pages





LINKAGE MENU

4 (Changing the operation direction)
Move the jog key left or right to display the second page of the screen. If you want to change the direction, use the jog key to move the cursor and use the [+] or [-] button to set normal or reverse.

F-4G 00:00.00 6.3V		
Model 1		
Trim / Dial select		
	Dir.	Step
DT1	Nor.	2
DT2	Nor.	2
DT3	Nor.	2
DT4	Nor.	2
DT5	Nor.	2
DT6	Nor.	2
DL1	Nor.	2

Setting direction

- Use the [+] or [-] button to select the [Nor.]/[Rev.].
(Nor.) Normal/(Rev.) Reverse

5 (Changing the operation step amount)
Move the jog key left or right to display the second page of the screen. If you want to change the step amount, use the jog key to move the cursor and use the [+] or [-] button to adjust the step amount.

F-4G 00:00.00 6.3V		
Model 1		
Trim / Dial select		
	Dir.	Step
DT1	Nor.	2
DT2	Nor.	2
DT3	Nor.	2
DT4	Nor.	2
DT5	Nor.	2
DT6	Nor.	2
DL1	Nor.	2

Adjust button

Adjust with the [+] or [-] button.
- Return to the initial value by press the [+] and [-] button simultaneously

Step range

1, 2, 5, 10, 20, 30, 40, 50, 100, 200
Initial value: 2

6 When finished, return to the Linkage menu screen by pressing the END button, or press and hold the END button to return to the Home screen.

Relationship between the set value and step amount

(Setting range: 1, 2, 5, 10, 20, 30, 40, 50, 100, 200)

-Steering trim/throttle trim

When set to the minimum "1", the total trim operating width is 200 clicks. For "100", the total operating width is 2 clicks and for 2PS, the total operating width is 1 click.

-Rate, etc. setting

This is the % value which is operated by 1 click relative to the set value of each rate. Since the total operating width of functions having a rate of -100~0~+100 is 200%, when set to "100", the total operating width is 2 clicks. Since the total operating width of functions with a 0~100 rate is 100%, "100" and "200" are operated by 1 click.

-Auxiliary channel

When set to the minimum "1", the total operating width of channel 3 is 200 clicks. For "100", the total operating width is 2 clicks and "200" is operated by 1 click.

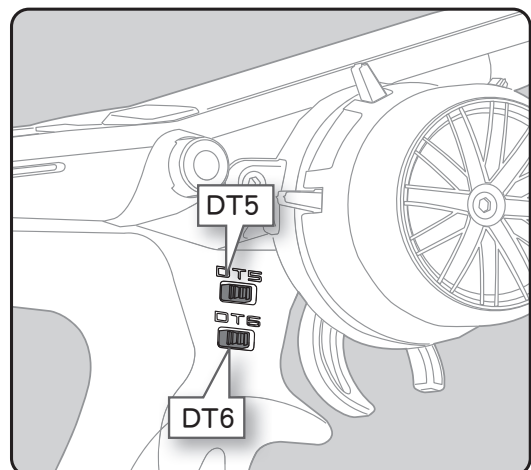
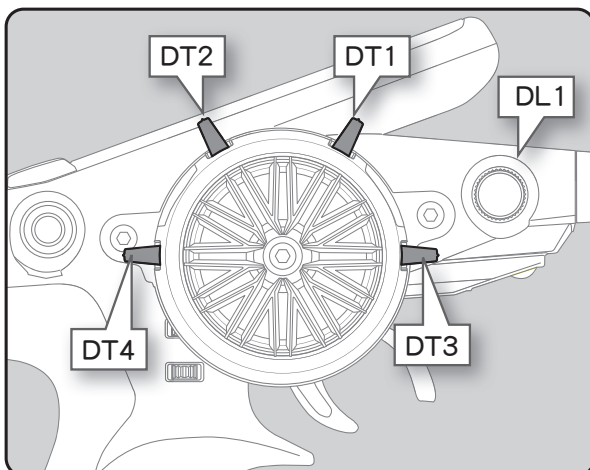



LINKAGE MENU

Set table functions (DT1, DT2, DT3, DT4, DT5, DT6, DL1)	
Name	Function
Steering trim	Steering trim
Throttle trim	Throttle trim
Channel 3-6 control	Channel 3-6 control
Dual rate	Dual rate function
Sub trim Ch.1 to 6	Sub trim Ch.1~6
Acceleration (forward)	Throttle acceleration (Forward side)
Acceleration (brake 1)	Throttle acceleration (Brake 1 side)
Acceleration (brake 2)	Throttle acceleration (Brake 2 side)
Acceleration (brake 3)	Throttle acceleration (Brake 3 side)
Steering curve	Steering curve (EXP) rate
Throttle curve	Throttle curve (EXP) (Forward side)
Steering speed(turn)	Steering speed (Turn side)
Steering speed(return)	Steering speed (Return side)
Th speed(turn)	Throttle speed (Turn side)
Th speed(return)	Throttle speed (Return side)
ABS(return brake 1)	Brake 1 A.B.S. function (Return amount)
ABS(delay brake 1)	Brake 1 A.B.S. function (Delay amount)
ABS(cycle brake 1)	Brake 1 A.B.S. function (cycle speed)
ABS(return brake 2)	Brake 2 A.B.S. function (Return amount)
ABS(delay brake 2)	Brake 2 A.B.S. function (Delay amount)
ABS(cycle brake 2)	Brake 2 A.B.S. function (cycle speed)
ABS(return brake 3)	Brake 3 A.B.S. function (Return amount)
ABS(delay brake 3)	Brake 3 A.B.S. function (Delay amount)
ABS(cycle brake 3)	Brake 3 A.B.S. function (cycle speed)
Traction control(return)	Traction control function (Return amount)
Traction control(delay)	Traction control function (Delay amount)
Traction control(cycle)	Traction control function (Cycle amount)
Brake 1 rate(ATL)	Brake 1 rate (ATL)
Brake EXP (brake 1)	Throttle EXP (Brake 1 side)
Brake delay (brake 1)	Brake mixing: Brake 1 delay
Brake rate (brake 2)	Brake1 rate (Brake 2 side)
Brake EXP (brake 2)	Throttle EXP (Brake 2 side)
Brake delay (brake 2)	Brake mixing: Brake 2 delay
Brake rate (brake 3)	Brake 1 rate (Brake 3 side)
Brake EXP (brake 3)	Throttle EXP (Brake 3 side)
Brake delay (brake 3)	Brake mixing: Brake 3 delay
Brake 2,3 rate	Brake mixing: Brake 2,3 rate function
Winch	Winch
Winch mixing (THR → Winch)	Winch mixing: Throttle to winch rate
Winch mixing (Winch → THR)	Winch mixing: Winch to throttle rate
Idle up	Idle up function rate
Prog. mixing 1~5 A	Program mixing: rate A side (Left/Forward/Upsides)
Prog. mixing 1~5 B	Program mixing: rate B side (Right/Brake/Downsides)
4WS rear rate	4WS mixing: (rear steering rate)
Dual ESC	Dual ESC mixing (Drive mode select)
Dual ESC ratio	Dual ESC mixing: drive ratio (front & rear)
Gyro gain	Gyro mixing: (Gain rate)
Ackermann	Ackermann mixing: (ackermann rate)
Throttle rate	Throttle rate
Engine cut	Engine cut
Gyro data	Gyro data
Steering response	Steering response
Throttle response	Throttle response
OFF	Not used



LINKAGE MENU



Switch select

This function allows the selection of the function to be performed by the switches (SW1-3, steering wheel, throttle trigger) and setting of the direction, etc. of operation.

- Next lists the functions that can be assigned to each push switch.
- The push switch SW3 is integrated with the DL1.
- All switches can be made alternating operations (ON/OFF changes each time SW pressed). (Nor./Alt.)
- The ON/OFF direction can be reversed. The reverse select function always starts from the ON state. However, the steering/trigger switch is different, depending on the position. (Nor./Rev.)

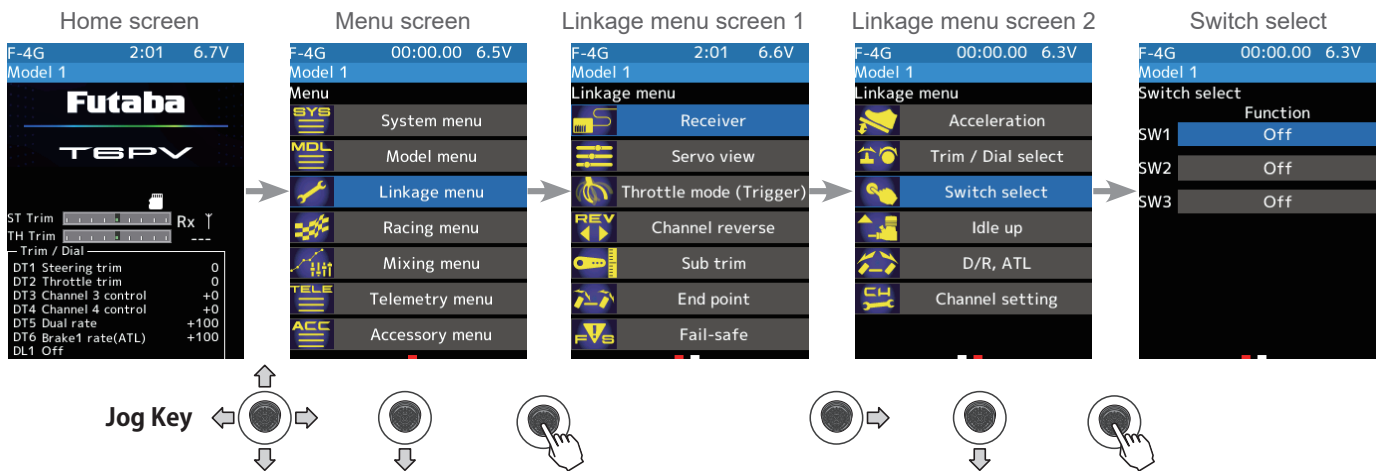

Function select dial setup

1 (Function setup)

Use the jog key to select the switch you want to set. Press the jog key to display the function list. Use the jog key to select a function and press it.

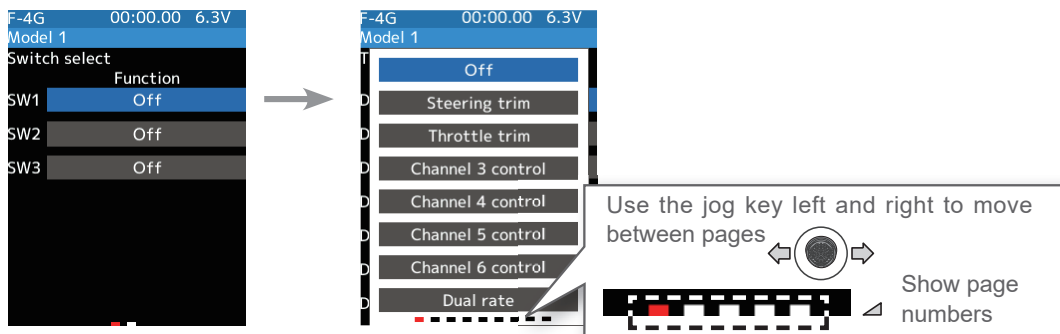



LINKAGE MENU

- 2** (Changing the operation direction)
Move the jog key left or right to display the second page of the screen. If you want to change the direction, use the jog key to move the cursor and use the [+] or [-] button to set normal or reverse.

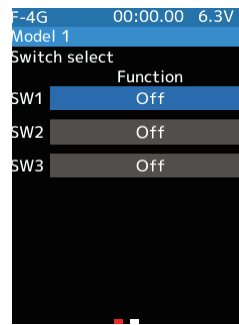

Use the jog key left or right to go to page 2

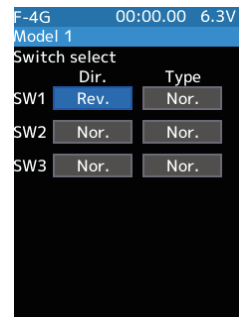

Setting direction

- Use the [+] or [-] button to select the [Nor.]/[Rev.].
(Nor.) Normal/(Rev.) Reverse

- 3** (Changing the SW operation type)
Move the jog key left or right to display the second page of the screen. If you want to change the SW operation type, use the jog key to move the cursor and use the [+] or [-] button to changing the SW operation type (Nor. or Alt.).

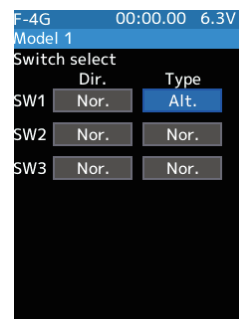

Switch Type

- Use the [+] or [-] button to select the [Nor.]/[Alt.].
(Nor.) Normal/(Alt.) Alternate

"Nor." : Press:ON Release:OFF

"Alt." : Press:ON → Press:OFF → Press:ON → Press:OFF ...

- 4** When finished, return to the Linkage menu screen by pressing the END button, or press and hold the END button to return to the Home screen.





LINKAGE MENU

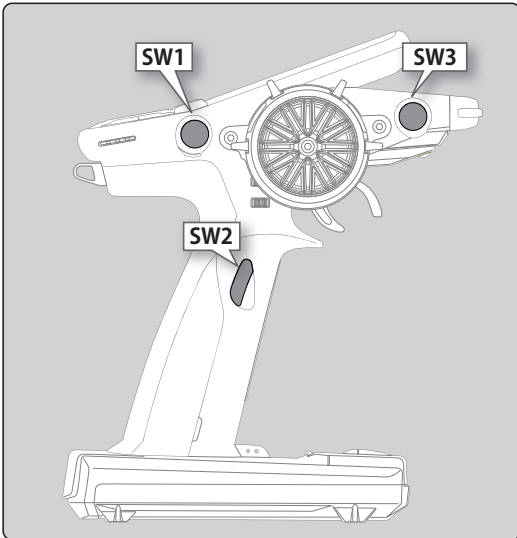

Set table functions	Push switch : SW1-SW3
Abbreviation used on the setup screen	Function name, etc
Channel 3 to 6 control	Operation of channel 3 to 6 (Number of channels varies by system.)
Program mixing (1-5)	Program mixing (1-5) function ON/OFF
A.B.S. (Brake 1)	A.B.S function brake 1 (2 channel) ON/OFF
A.B.S. (Brake 2,3)	A.B.S function brake 2,3 (Auxiliary channel) ON/OFF
Traction control	Traction control function ON/OFF
4WS Type switching	4WS mixing function ON/OFF & type select
4WS Type1 (Front)	4WS mixing function type1 (Front) select
4WS Type2 (Reverse)	4WS mixing function type2 (Reverse) select
4WS Type3 (Same)	4WS mixing function type3 (Same) select
4WS Type4 (Rear)	4WS mixing function type4 (Rear) select
Dual ESC	Dual ESC mixing
Dual ESC (Rear)	Dual ESC mixing (Rear Drive mode)
Dual ESC (4WD)	Dual ESC mixing (4WD mode)
Dual ESC (Front)	Dual ESC mixing (Front Drive mode)
Gyro mixing	Switching GYRO mode function ON/OFF
Gyro gain	Switching GYRO mode (Switch of Gain1 and Gain2 in the same group)
Gyro group switching	Switching GYRO mode (Switch of Gain group)
CPS mixing (1-3)	CPS up function ON/OFF
Brake	Steering mixing (Brake function ON/OFF)
Start	Start function trigger wait ON/OFF
Engine cut	Engine cut function ON/OFF
Idle up	Idle up function ON/OFF
Neutral brake	Neutral brake function ON/OFF
Timer start	Timer function start/stop
Timer reset	Timer function reset
Telemetry log	Telemetry data logging ON/OFF
Screen capture	Save images of the currently displayed screen to microSD card.
Backlight	LCD backlight ON
Throttle rate	Throttle rate ON/OFF
Gyro data 1-5	Gyro data 1-5
Trans-Brake	Trans-Brake ON/OFF

The HOME screen display

When the push switch is operated, the state of the function is displayed for a few seconds at the top of the screen.

Example:

When the push switch to which ON/OFF of the neutral brake is assigned is operated.

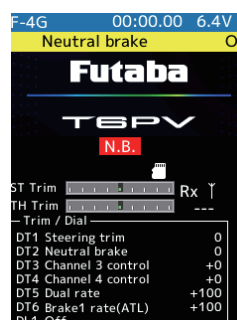

Neutral brake ON/OFF is indicated on the home screen for a few seconds.



LINKAGE MENU



Idle-up

To use the "Idle-Up" function, the switch set by the "Switch select" function (Linkage menu) is necessary. This function is used to improve engine starting performance by raising the idling speed when starting the engine of a GP car (boat). It is also effective when you want to prevent braking when the power is turned off during running, due to the effect of your gear ratio setting and choice of the motor when operating an electronic car. However, considering safety, and to prevent the motor from rotating instantly when the power is turned on, Futaba electronic motor speed controller (ESC) will not enter the operation mode if the neutral position is not confirmed. When using the Futaba ESC, verify that the ESC is in the neutral position and the set is in the operation mode before setting the idle up function switch to ON.

Operation

The throttle neutral position is offset to the forward side or brake side. There is no linkage locking, etc. Because there is no change near the maximum operation angle even when the neutral position is offset by this function.

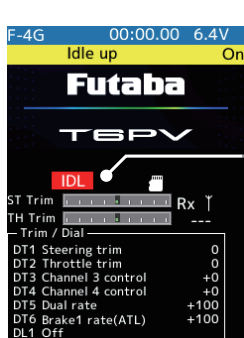
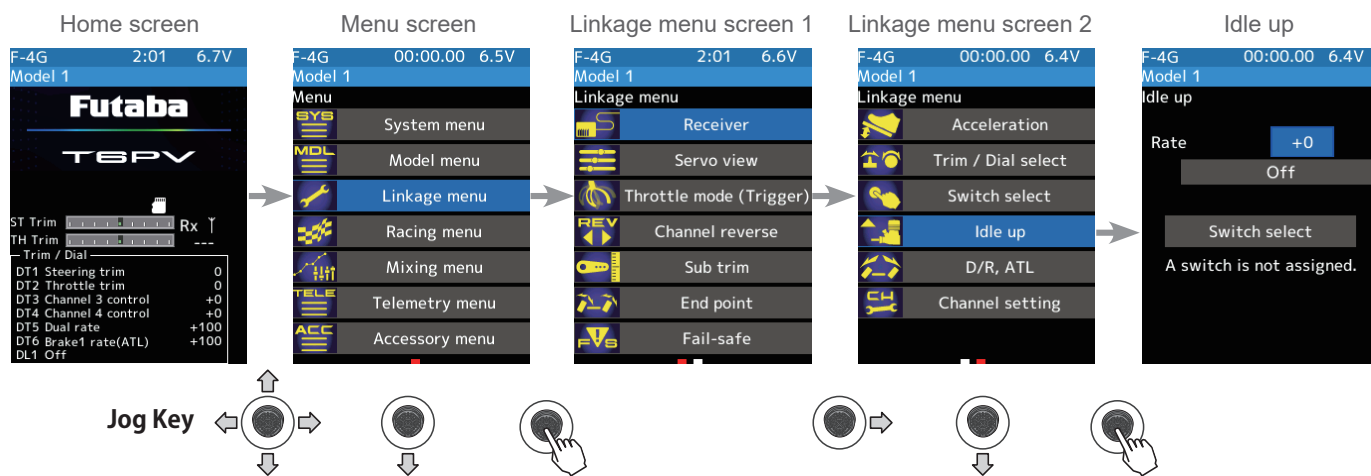

Idle-up ON/OFF is indicated on the home screen for a few seconds.

It is displayed on the home screen when the Idle-up is ON.

If the power switch is turned on while the Idle-up switch is on, an audible alarm will be heard. Immediately set the Idle-up switch to OFF.



LINKAGE MENU

Idle-up function adjustment

(Preparation)

- In the [Switch select] function(Linkage menu), set the ON/OFF switch for the idle-up function. If it is not set, “A switch is not assigned” will be displayed, so select [Switch select] with the jog key and press it to move to the switch setting screen and set the switch.

Example of setting SW1 as an idle up switch

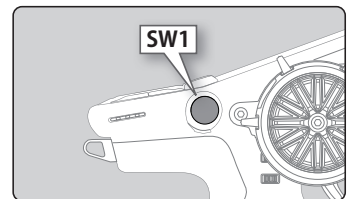
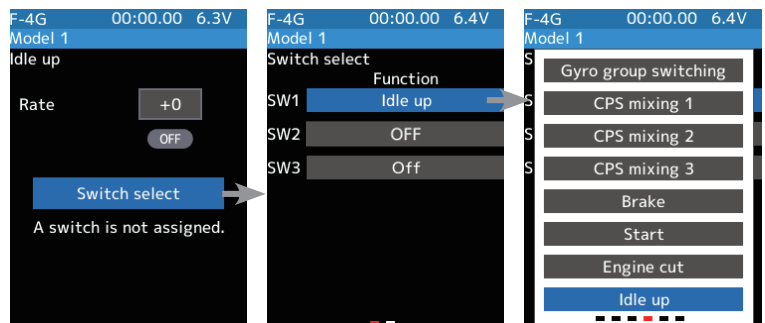

1 (Idle-up rate)

With the cursor on the [Rate] number, use the [+] or [-] button to set the idle-up rate.

Adjust button

Adjust with the [+] or [-] button.
- Return to the initial value by press the [+] and [-] button simultaneously

Idle-up rate

-50~+0~+50
Initial value: +0

2 When finished, return to the Linkage menu screen by pressing the END button, or press and hold the END button to return to the Home screen.

Trim/Dial Setting

The function select dial function can control the Idle-up rate with digital dial or digital trim (Linkage menu).



LINKAGE MENU



D/R, ATL

D/R (Steering dual rate)

The steering left and right servo travels are adjusted simultaneously. This setting is linked to transmitter grip trim DT5. When DT5 is assigned another function, the dual rate can be adjusted with this screen.

ATL (Brake 1 rate)

This function decreases the set value when the braking effect is strong and increases the set value when the braking force is weak. This function is linked to transmitter grip trim DT6. When DT6 is assigned another function, this function can be set with this screen.

Throttle rate

Even if the throttle trigger is set to full speed, the amount of throttle movement can be adjusted so that it does not reach full throttle.

- By assigning the [Throttle rate] function on the switch setting screen, you can switch the function ON / OFF according to the situation.
- Throttle rate can be adjusted with the dial DL1 and digital trim DT1 to DT6 in the [trim / dial settings].

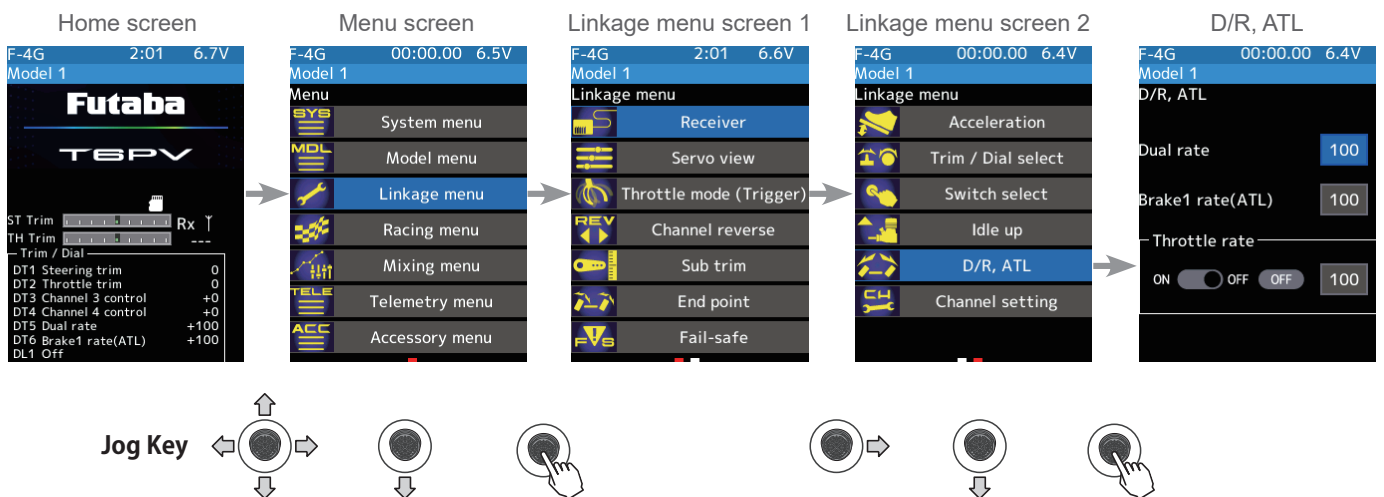

Dual rate adjustment

- 1 Use the jog key to move the cursor to the [Dual rate] value, and then use the [+] or [-] button to set the rate.

When finished, return to the Linkage menu screen by pressing the END button, or press and hold the END button to return to the Home screen.

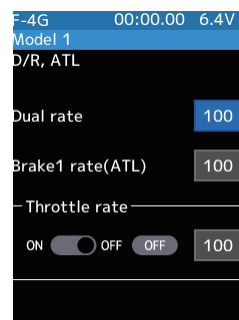

Adjust button

Adjust with the [+] or [-] button.
- Return to the initial value by press the [+] and [-] button simultaneously

Dual rate

0~100
Initial value: 100



LINKAGE MENU

Brake rate (ATL) adjustment

- 1 Use the jog key to move the cursor to the [Brake1 rate (ATL)] value and use the [+] or [-] button to set the rate.

When finished, return to the Linkage menu screen by pressing the END button, or press and hold the END button to return to the Home screen.

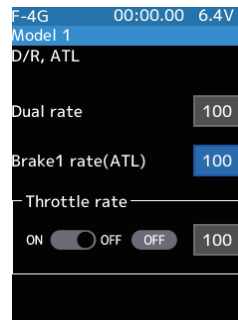

Adjust button

- Adjust with the [+] or [-] button.
- Return to the initial value by press the [+] and [-] button simultaneously

Brake rate(ATL)

0~100
Initial value: 100

Throttle rate adjustment

- 1 (Throttle rate Function ON/OFF)
Use the jog key to select ON/OFF and then use the [+] or [-] button to set.

"OFF": Function OFF
"ON": Function ON

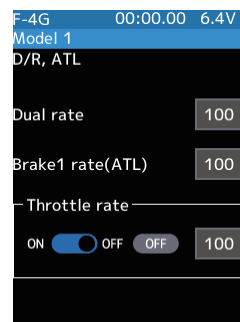

Setting

- Use the [+] or [-] button to set (ON)/(OFF).

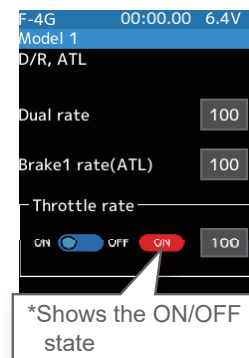

- 2 Use the jog key to move the cursor to the [Throttle rate] value and use the [+] or [-] button to set the rate.

When finished, return to the Linkage menu screen by pressing the END button, or press and hold the END button to return to the Home screen.

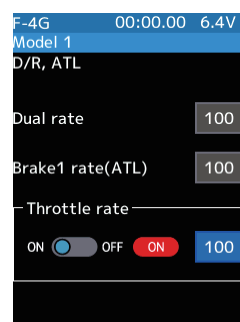

Adjust button

- Adjust with the [+] or [-] button.
- Return to the initial value by press the [+] and [-] button simultaneously

Throttle rate

0~100
Initial value: 100



LINKAGE MENU



Channel setting

This function assigns steering or throttle to any channel. You can operate steering and throttle on other channels, and operate other channels in the same way as steering and throttle.

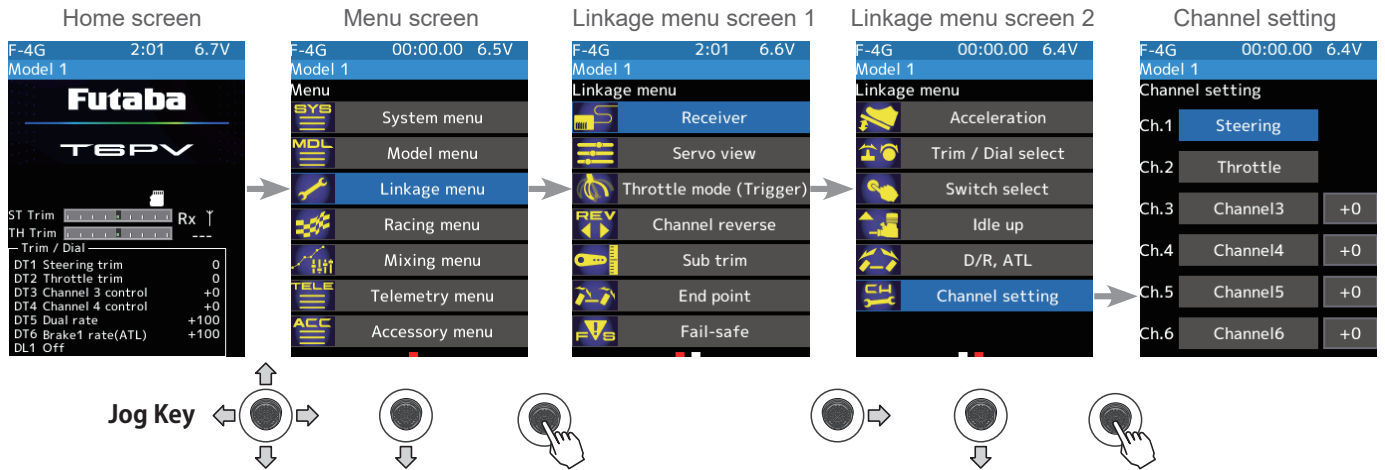

The number of channels varies depending on the selected system.

How to select steering/throttle

1 (Channel setup)
 Select a channel with the jog key and press it to display a pop-up screen. Select the desired function with the jog key and press it.

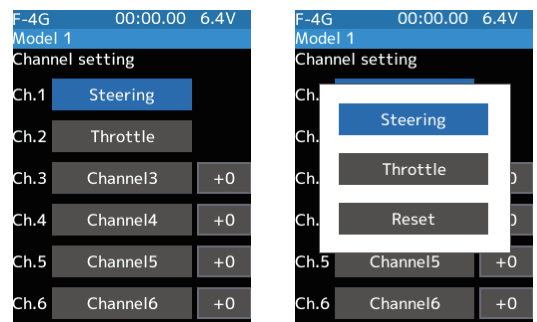

2 (Position setting of the auxiliary channel)
 If there is no switch, trim/dial, etc. To operate the auxiliary channel, you can set the position here.

Select the jog key the rate display part of the channel you want to adjust. Use the [+] or [-] button to adjust the position.



Adjust button
 Adjust with the [+] or [-] button.
 - Return to the initial value by press the [+] and [-] button simultaneously

Position
 -100~+0~+100
 Initial value: +0

3 When finished, return to the Linkage menu screen by pressing the END button, or press and hold the END button to return to the Home screen.



RACING MENU



Curve (EXP)

Steering curve

This function is used to change the sensitivity of the steering servo around the neutral position. It does not affect the maximum servo travel.

Home screen Menu screen Racing menu screen Curve(EXP) screen

Home screen: Futaba TSPV, Model 1, DT1 Steering trim 0, DT2 Throttle trim 0, DT3 Channel 3 control +0, DT4 Channel 4 control +0, DT5 Dual rate +100, DT6 Brake1 rate(ATL) +100, DL1 Off.

Menu screen: Menu, SYS System menu, MDL Model menu, Linkage menu, Racing menu, Mixing menu, TELE Telemetry menu, ACC Accessory menu.

Racing menu screen: Racing menu, Curve(EXP), Speed, Traction control, A.B.S., Start, Engine cut, Response.

Curve(EXP) screen: Steering curve, Throttle curve, Brake curve.

EXP curve screen: Steering curve graph, EXP rate Type EXP Rate +0. * Press [+] or [-] button the type to switch the curve type.

Quick (Positive side) / Mild (Negative side) diagrams showing servo travel and wheel operation.

Quick (Positive side) / Mild (Negative side) diagrams showing servo travel and wheel operation.

VTR curve screen: Steering curve graph, VTR rate Type VTR Rate -50 Point 50.

Quick (Positive side) / Mild (Negative side) diagrams showing servo travel and wheel operation.



RACING MENU

Trim/Dial Setting

The steering EXP, VTR adjustment can be controlled with digital trim DT1 to DT6 or digital dial DL1 etc. with the trim/dial select function. (Linkage menu)

EXP adjustment

(Preparation)

-Press jog key the curve type and select [EXP].

- 1 Select the value with jog key of the [EXP rate]. Use the [+] or [-] button to set the rate. When you want to quicken steering operation, use the [+] button to adjust the + side. When you want to make steering operation milder, use the [-] button to adjust the - side.

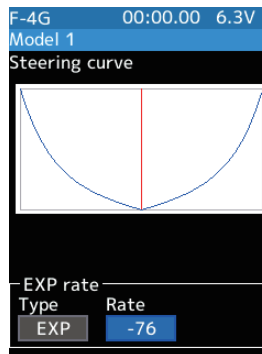

Adjustment buttons

- Adjust with the [+] or [-] button.
- Return to the initial value by press the [+] and [-] button simultaneously

Curve rate

-100~+100
Initial value: +0

- 2 When finished, return to the Racing menu screen screen by pressing the END button, or press and hold the END button to return to the Home screen.

VTR adjustment

(Preparation)

-Press jog key the curve type and select [VTR].

- 1 Select the value with jog key of the [VTR rate]. Use the [+] or [-] button to set the rate. When you want to quicken steering operation, use the [+] button to adjust the + side. When you want to make steering operation milder, use the [-] button to adjust the - side.

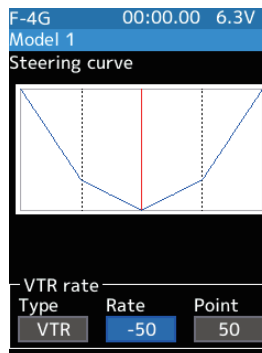

Adjustment buttons

- Adjust with the [+] or [-] button.
- Return to the initial value by press the [+] and [-] button simultaneously

Curve rate

-100~+100
Initial value: +0

Point

1~99

Initial value: 50

- 2 Curve switching point adjustment

Select the value with jog key of the [Point]. use the [+] or [-] button to move to the point you want to set.

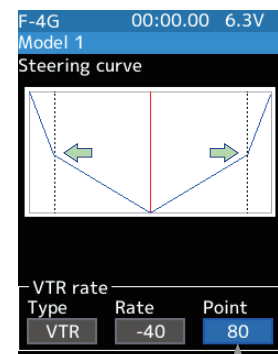
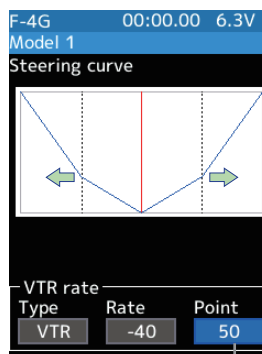

- 3 When finished, return to the Racing menu screen screen by pressing the END button, or press and hold the END button to return to the Home screen.



RACING MENU

Throttle curve (Forward side)

This function makes the throttle high side direction servo operation quicker or milder. It has no effect on the servo maximum operation amount.

The selection from among three kinds of curves (EXP/VTR) is also possible.

Advice

When the course conditions are good and the surface has good grip, set each curve to the plus [+] side (quick side). When the road surface is slippery and the drive wheels do not grip it, set each curve to the minus [-] side (mild).

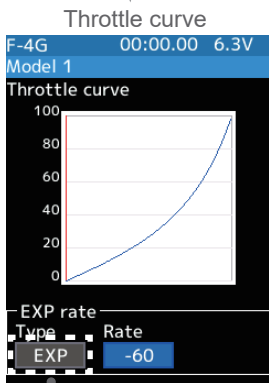
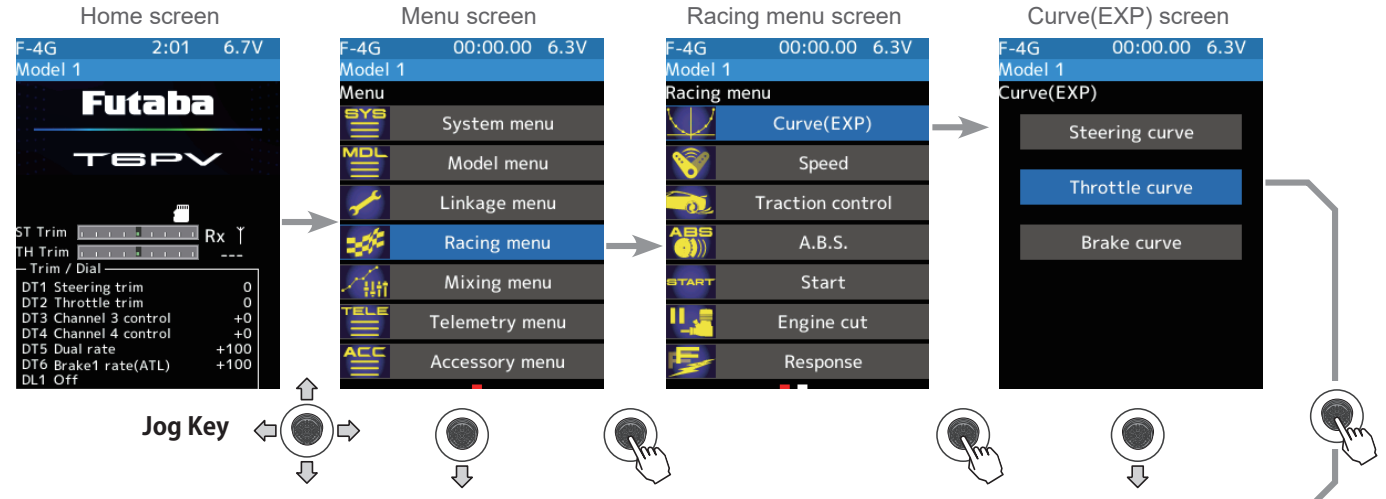

EXP curve screen
Curve type which operates the throttle from the neutral point to the high point on a curved curve.

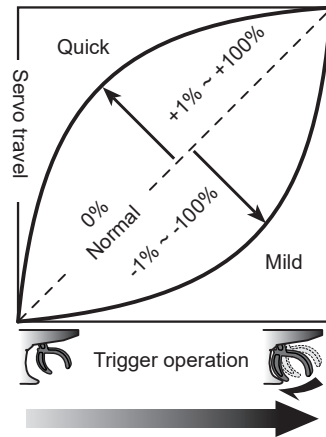

* Press [+] or [-] button the type to switch the curve type.

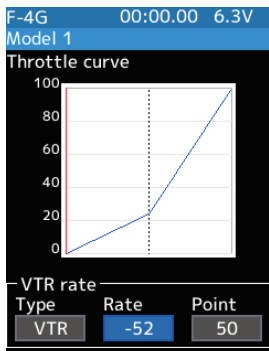

VTR curve screen
Curve type which sets the switching point between the throttle neutral point and high point and operates the throttle on a linear curve.

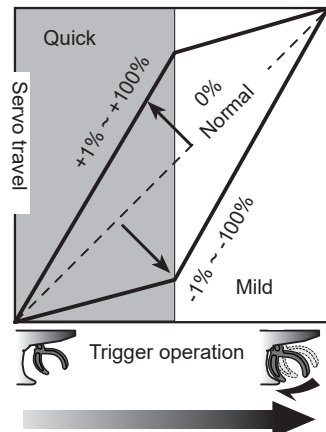



RACING MENU

Trim/Dial Setting

The steering EXP, VTR adjustment can be controlled with digital trim DT1 to DT6 or digital dial DL1 etc. with the trim/dial select function. (Linkage menu)

EXP adjustment

(Preparation)

-Press jog key the curve type and select [EXP].

- 1 Select the value with jog key of the [EXP rate]. Use the [+] or [-] button to set the rate. When you want to quicken throttle operation, use the [+] button to adjust the + side. When you want to make throttle operation milder, use the [-] button to adjust the - side.

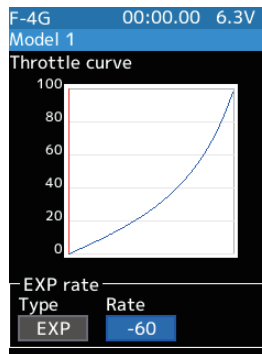

Adjustment buttons

- Adjust with the [+] or [-] button.
- Return to the initial value by press the [+] and [-] button simultaneously

Curve rate

-100~+100
Initial value: +0

- 2 When finished, return to the Racing menu screen screen by pressing the END button, or press and hold the END button to return to the Home screen.

VTR adjustment

(Preparation)

-Press jog key the curve type and select [VTR].

- 1 Select the value with jog key of the [VTR rate]. Use the [+] or [-] button to set the rate. When you want to quicken throttle operation, use the [+] button to adjust the + side. When you want to make throttle operation milder, use the [-] button to adjust the - side.

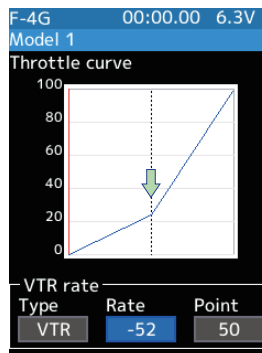

Adjustment buttons

- Adjust with the [+] or [-] button.
- Return to the initial value by press the [+] and [-] button simultaneously

Curve rate

-100~+100
Initial value: +0

Point

1~99

Initial value: 50

- 2 Curve switching point adjustment

Select the value with jog key of the [Point]. use the [+] or [-] button to move to the point you want to set.

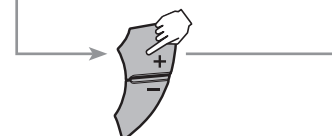
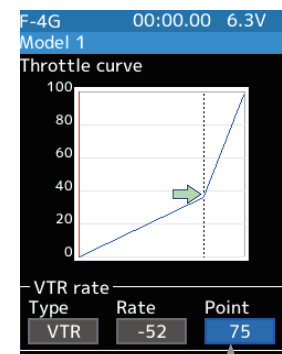
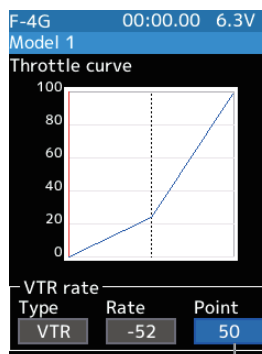

- 3 When finished, return to the Racing menu screen screen by pressing the END button, or press and hold the END button to return to the Home screen.



RACING MENU

Brake curve

This function makes the servo operation on the brake side faster or gentler. It does not affect the maximum servo movement. The selection from among two kinds of curves (EXP/VTR) is also possible. If the Ratio is set to 100:0 with the trigger function (Linkage menu→Throttle mode), the brake side will not operate. Since the setting method of each curve is the same as the throttle (forward) side curve, please read previous page “Throttle curve”.

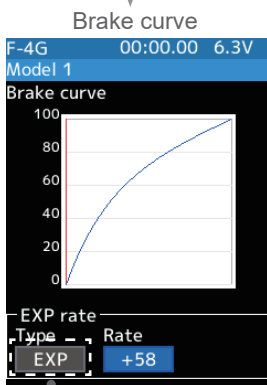
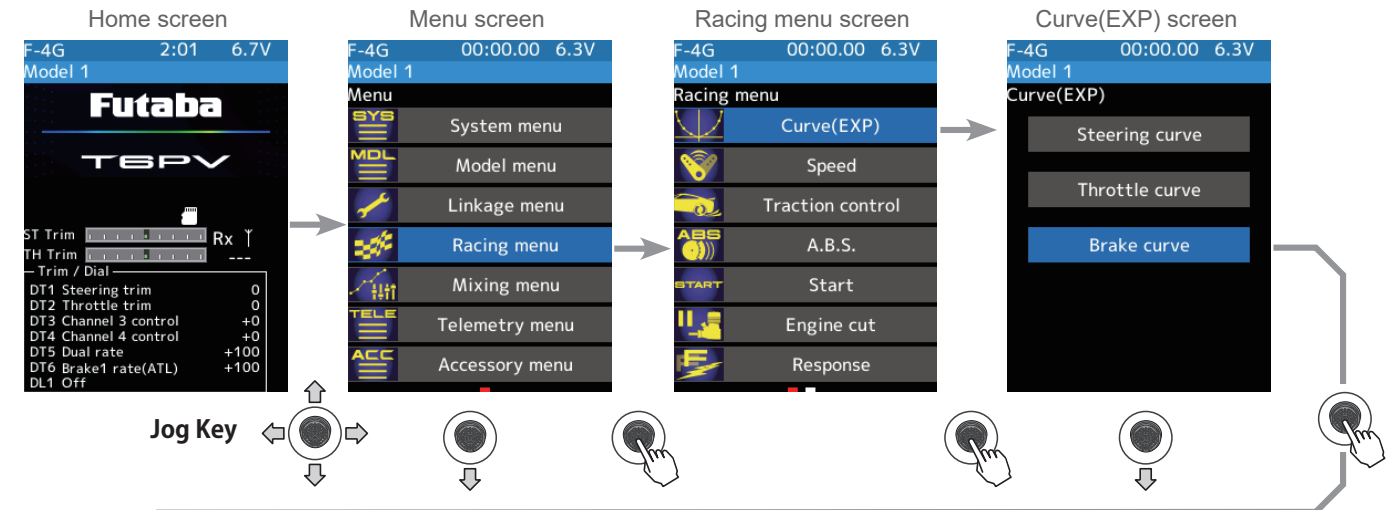

EXP curve screen

Curve type which operates the throttle from the neutral point to the high point on a curved curve.

* Press [+] or [-] button the type to switch the curve type.

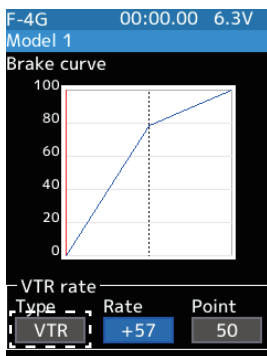

VTR curve screen

Curve type which sets the switching point between the throttle neutral point and high point and operates the throttle on a linear curve.

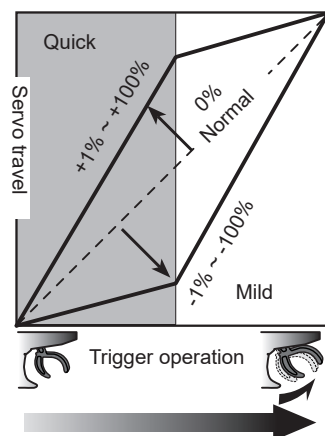
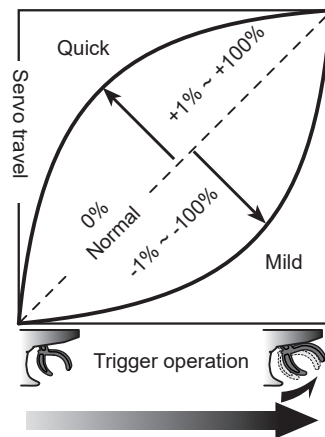

Trim/Dial Setting

The throttle/brake EXP, VTR adjustment can be controlled with digital trim DT1 to DT6 or digital dial DL1 etc. with the trim/dial select function. (Linkage menu)



RACING MENU



Speed

Steering speed

Quick steering operation will cause momentary understeering, loss of speed, or spinning. This function is useful in such cases.

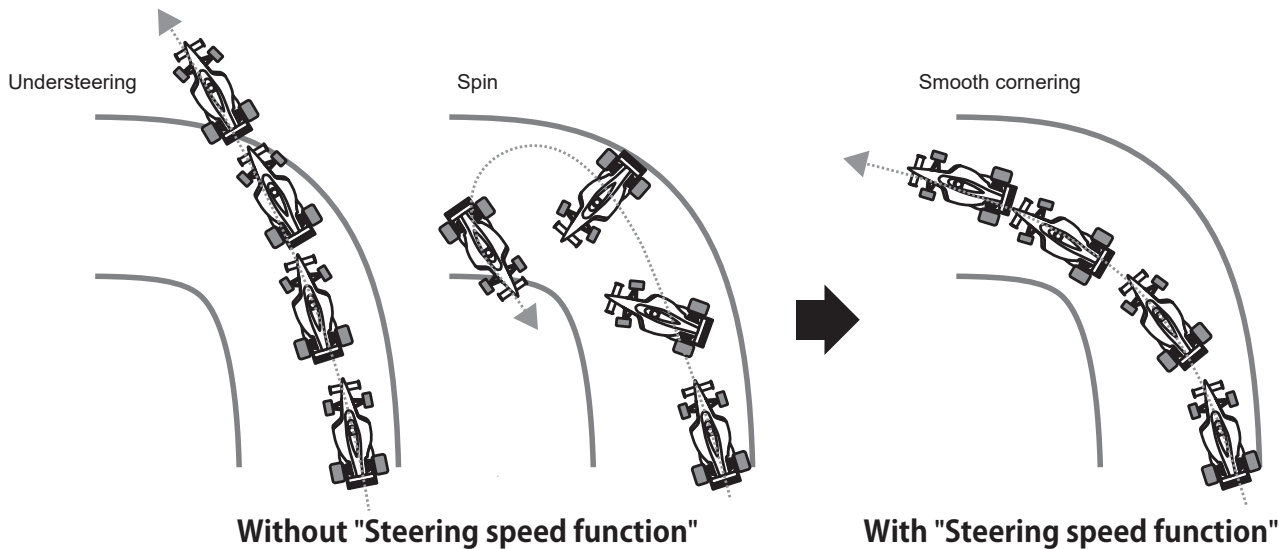

Operation

- This function limits the maximum speed of the steering servo. (Delay function)
- The steering speed when the steering wheel is operated (Turn direction) and returned (Return direction) can be independently set.
- If the steering wheel is turned slower than the set speed, the steering servo is not affected.

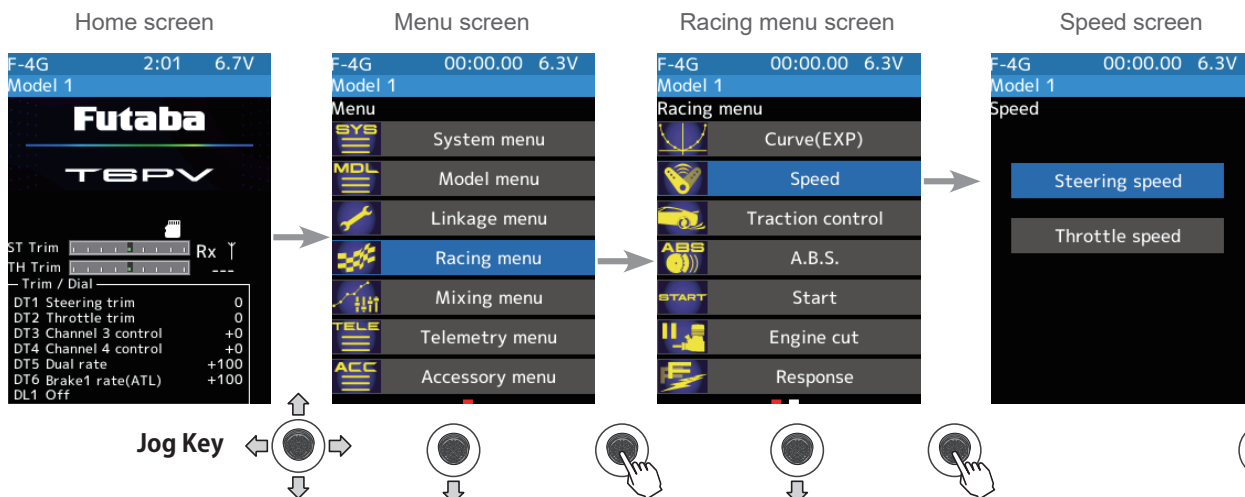
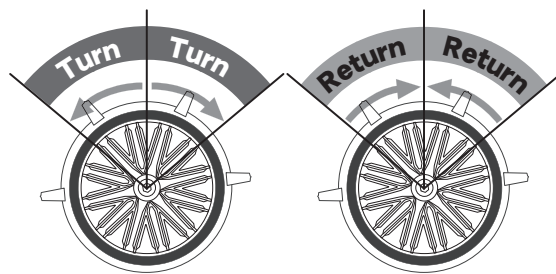



RACING MENU

Steering Speed adjustment

1 ("Turn" direction delay adjustment)

Select the value with jog key of the [Turn]. Use the [+] or [-] button to adjust the turn speed amount.

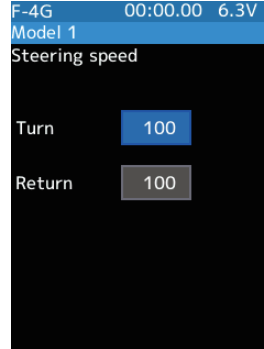
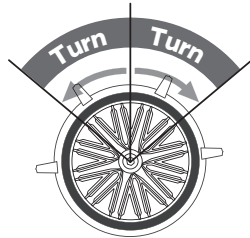

Adjustment buttons

- Adjust with the [+] or [-] button.
- Return to the initial value by press the [+] and [-] button simultaneously

Speed range

1~100

Initial value:
100, there is no delay.

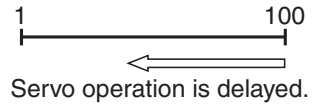

2 ("Return" direction adjustment)

Select the value with jog key of the [Return]. Use the [+] or [-] button to adjust the return speed amount.

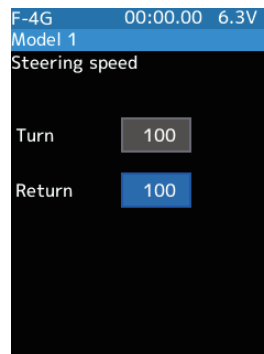
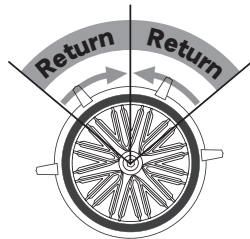

Adjustment buttons

- Adjust with the [+] or [-] button.
- Return to the initial value by press the [+] and [-] button simultaneously

Speed range

1~100

Initial value:
100, there is no delay.

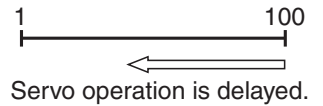

3 When finished, return to the Racing menu screen screen by pressing the END button, or press and hold the END button to return to the Home screen.

Trim/Dial Setting

The steering speed adjustment "Turn" and "Return" adjustment can be controlled with digital trim DT1 to DT6 or digital dial DL1 etc. with the trim/dial select function. (Linkage menu)



RACING MENU

Throttle speed

Sudden throttle trigger operation on a slippery road only causes the wheels to spin, and the vehicle cannot accelerate smoothly. Setting the throttle speed function reduces wasteful battery consumption while at the same time permitting smooth, enjoyable operation.

Without "Throttle speed function"

Slow start due to skidding



With "Throttle speed" function

Quick start without skidding



Operation

-Throttle servo (ESC) operation is delayed so that the drive wheels will not spin even if the throttle trigger is operated more than necessary. This delay function is not performed when the throttle trigger is returned and at brake operation.

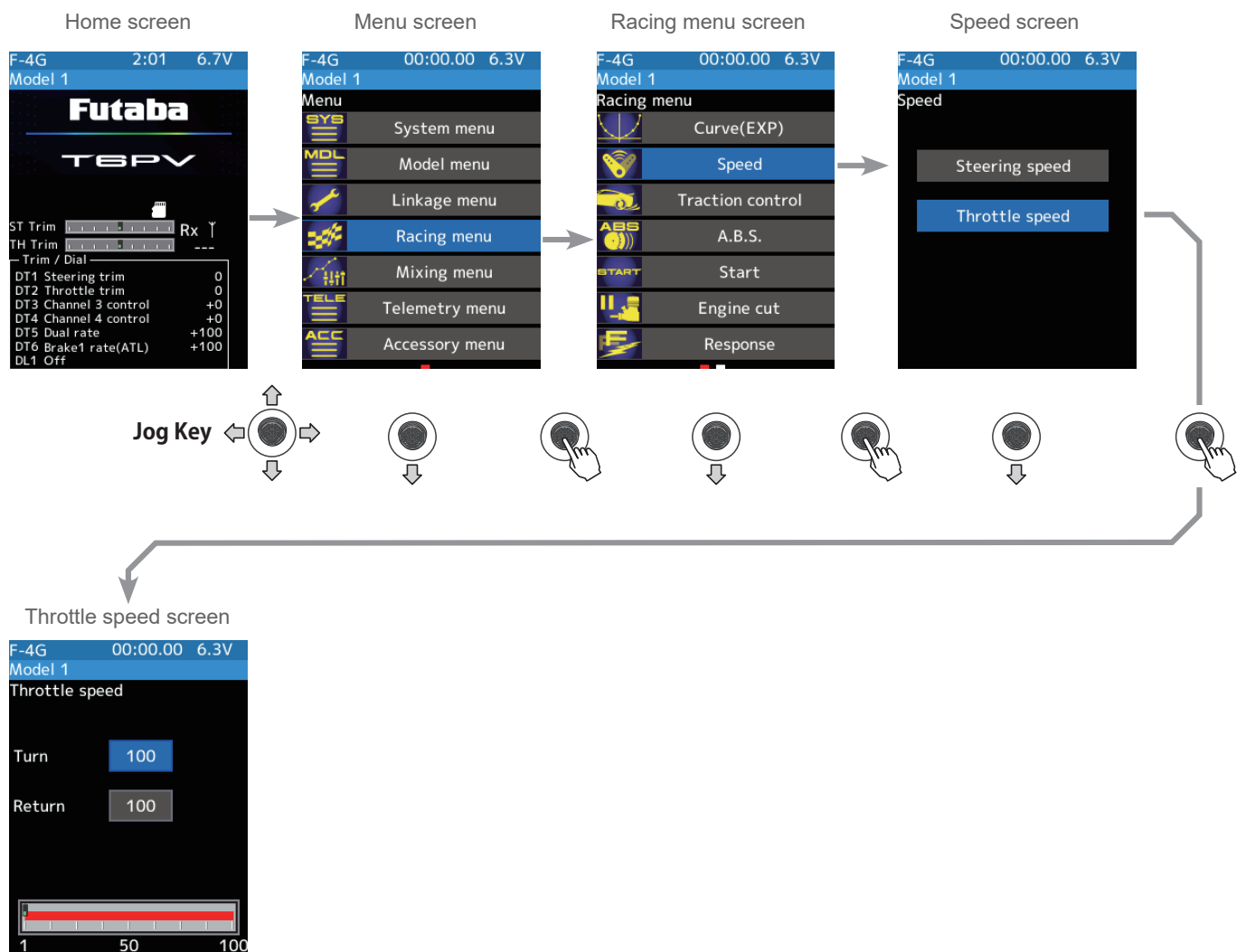



RACING MENU

Adjustment method for Speed mode

(Preparation)

-Use the jog key to select [Throttle Speed] and press it.

1 (Turn direction delay adjustment)

Select [Turn] side of the value button. Use the [+] or [-] button to adjust the turn speed amount.

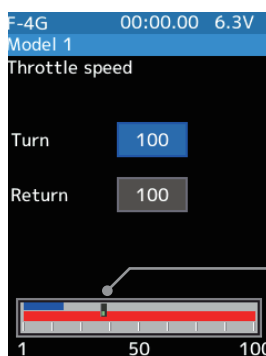

Adjustment buttons

- Adjust with the [+] or [-] button.
- Return to the initial value by press the [+] and [-] button simultaneously

Speed range

1~100

Initial value:

100, there is no delay.

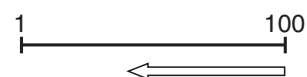

Servo operation is delayed.

2 (Return direction delay adjustment)

Select [Return] side of the value button. A warning is displayed saying, "Return speed will be slow. Please be careful.". If you want to use the return, with the cursor on [Close], press the jog key. Use the [+] or [-] button to adjust the return speed amount.

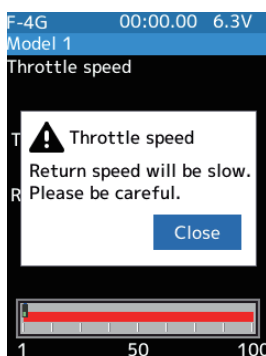

Adjustment buttons

- Adjust with the [+] or [-] button.
- Return to the initial value by press the [+] and [-] button simultaneously

Speed range

1~100

Initial value:

100, there is no delay.

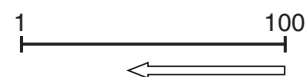

Servo operation is delayed.

3 When finished, return to the Racing menu screen screen by pressing the END button, or press and hold the END button to return to the Home screen.

Trim/Dial Setting

The throttle speed adjustment "Turn" and "Return" adjustment can be controlled with digital trim DT1 to DT6 or digital dial DL1 etc. with the trim/dial select function. (Linkage menu)

⚠ Warning

- ❶ Setting the speed function in the return direction slows the deceleration of the car, so please be careful to set it carefully.



RACING MENU



Traction control

Trigger operation with cornering on a slippery road surface is hard to get traction, and smooth cornering cannot be done. By intermittently operating the operation of the throttle, you can smoothly navigate and travel on driving lines. Also, with a drift car, by intermittently operating the motor in the high point direction, a pseudo revving engine sound can be reproduced.

Operation

- During throttle operation, the throttle servo is intermittently operated in the forward direction.
- You can set the amount of return to the slow side, the amount of delay, the speed of pumping, the operating point, and the duty ratio of pumping.
- You can choose the action on the slow side near the neutral and the action on the high point side.

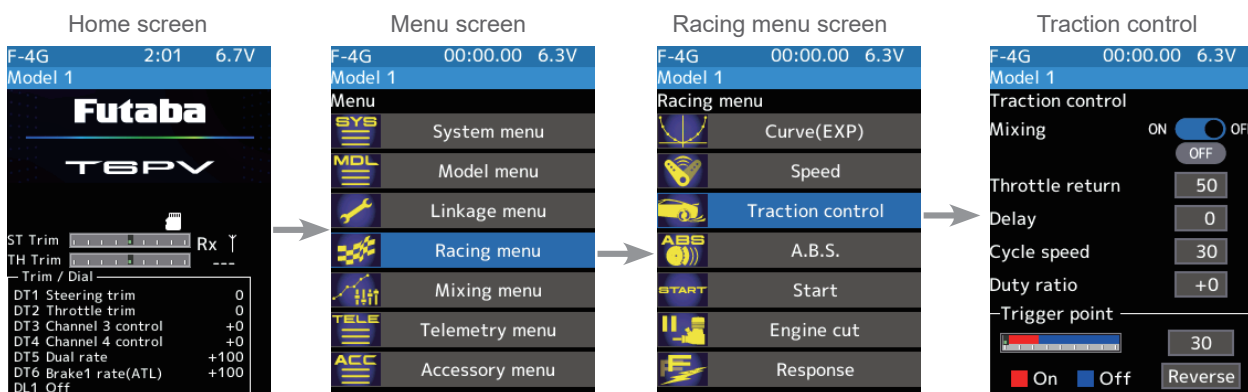

Jog Key

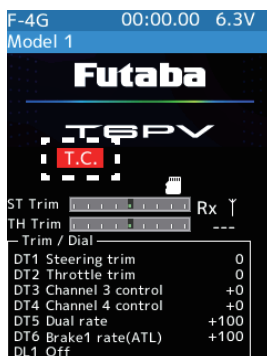
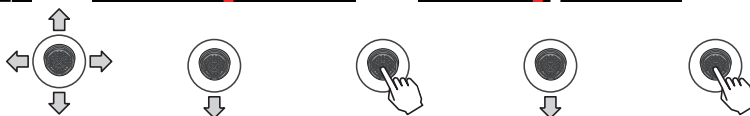

It is displayed in the home screen. When the traction control is ON.

- Mode : Function ON/OFF

Traction control function ON/OFF setting. When using the Traction control function, set to "ON".

- Throttle return

Set the ratio at which the servo returns to the slow side with respect to the trigger operation. If set to 0%, the traction control function will not work. At 50%, it returns to the neutral position at 50% (half), 100% of the trigger operation amount.

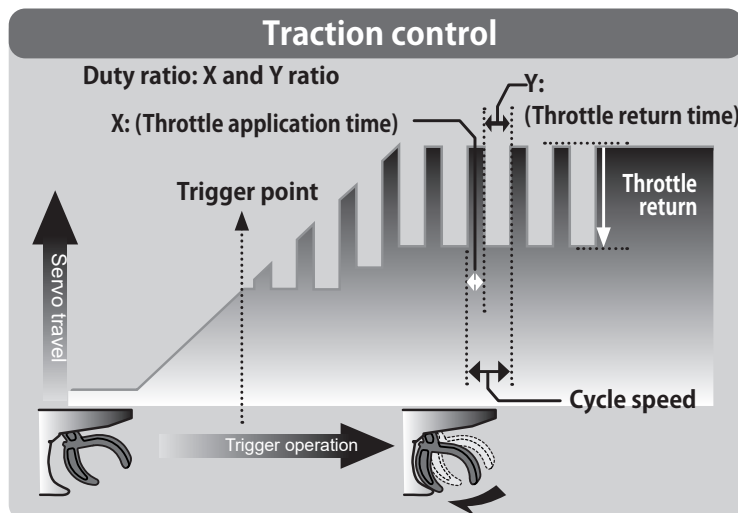



RACING MENU

- Delay

Set the delay from when the throttle is operated until when the traction control operation starts. When set to 0%, the traction control function works without delay. At 50%, the traction control function works approximately 0.5-seconds later, and the traction control function works about 1.0-seconds later at 100%.

- Cycle speed

The lower this setting, the faster the pulse speed. Set value, the quicker the pulse speed.

- Duty ratio

Set the ratio of the time to operate to the high side and the time to operate to the slow side in the pumping operation.

The ratio can be set to +4 ~ +0 ~ -4 in 9 steps.

- Trigger point

In the throttle operation, set the position of the trigger at which traction control starts to work. Normal/Reverse, reverse the throttle operation range where the traction control operates, with the trigger point as the boundary.

Traction control function adjustment

1 (Function ON/OFF)

With the cursor on Mixing ON/OFF, press the [+] or [-] button to select ON/OFF.

"OFF": Traction control function OFF

"ON": Traction control function ON

When using traction control function ON/OFF by switch, use the switch select function (Linkage menu) to set the switch to be used.



2 ("Throttle return" amount adjustment)

Use the jog key to place the cursor on the [Throttle return] value. Use the [+] or [-] button to adjust the return amount.

"0": No return

"50": Return to the 50% position of the brake operation amount

"100": Return to the neutral position.

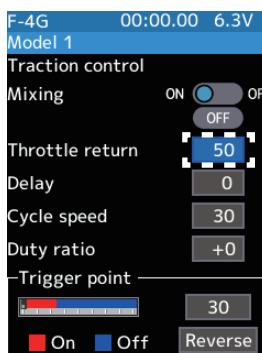
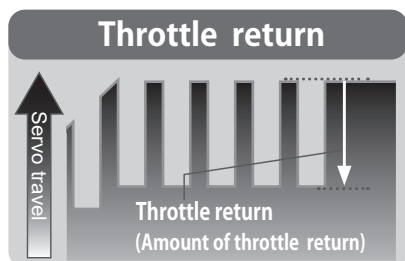

Adjustment buttons

- Adjust with the [+] or [-] button.
- Return to the initial value by press the [+] and [-] button simultaneously

Return amount

0~50~100
Initial value: 50

The amount of throttle return varies depending on the curve setting of the throttle etc.



RACING MENU

3 ("Delay" amount setup)

Select the value with jog key of the [Delay]. Use the [+] or [-] button to adjust the delay amount.

- "0": Function performed without any delay
- "50": Function performed after an approximate 0.5-sec delay.
- "100": Function performed after an approximate 1.0-sec delay.



Adjustment buttons

- Adjust with the [+] or [-] button.
- Return to the initial value by press the [+] and [-] button simultaneously

Delay amount

0~100
Initial value: 0

4 ("Cycle speed" adjustment)

Select the value with jog key of the [Cycle speed]. Use the [+] or [-] button to adjust the cycle speed amount.

- The lower this setting, the faster the pulse speed. Set value, the quicker the pulse speed.

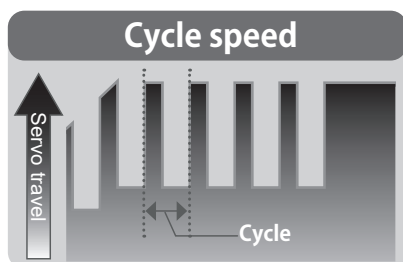

Adjustment buttons

- Adjust with the [+] or [-] button.
- Return to the initial value by press the [+] and [-] button simultaneously

Cycle speed amount

1~100
Initial value: 30

5 ("Duty ratio" setup)

Select the value with jog key of the [Duty ratio]. Use the [+] or [-] button to adjust the duty ratio amount.

- "-4": Brake application time becomes shortest. (Brakes lock with difficulty)
- "+4": Brake application time becomes longest (Brakes lock easily)

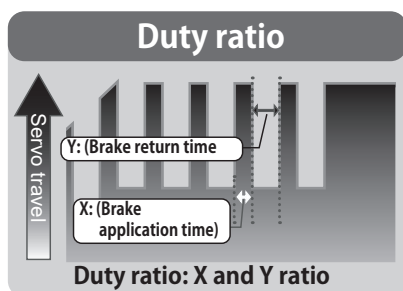

Adjustment buttons

- Adjust with the [+] or [-] button.
- Return to the initial value by press the [+] and [-] button simultaneously

Duty ratio amount

-4~+0~+4
Initial value: +0



RACING MENU

6 ("Trigger point" setup)

Select the value with jog key of the [Trigger point]. Use the [+] or [-] button to adjust the operation point.

- Sets the throttle trigger position at which the traction control function is performed. The number is the % display with the full brake position made 100.

Select [Normal] or [Reverse] to set the operating range.

Use the jog key to place the cursor on Normal/Reverse and press the [+] or [-] button to select.

"Normal": High range from the trigger point to the operating range.

"Reverse": Operating range from neutral to trigger point.

Adjustment buttons

- Adjust with the [+] or [-] button.
- Return to the initial value by press the [+] and [-] button simultaneously

Trigger point

5~95

Initial value: 30

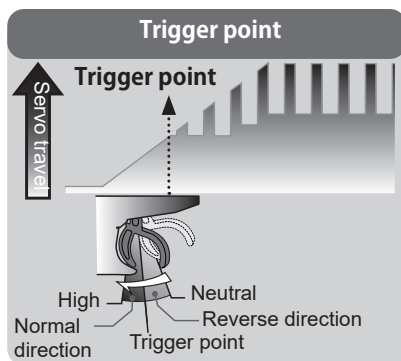

* Throttle trigger position

7 When finished, return to the Racing menu screen by pressing the END button, or press and hold the END button to return to the Home screen.

Switch setting

Use switch the traction control function ON/OFF.
See the switch select function. (Linkage menu)

Trim/Dial Setting

The throttle return amount, delay amount, and cycle speed can be controlled with digital trim DT1 to DT6 or digital dial DL1, etc. with the trim/dial select function. (Linkage menu)



RACING MENU



A.B.S.

When the brakes are applied while cornering with a 4-Wheel Drive or other types of vehicles, understeer may occur. The tendency to understeer can be eliminated and corners can be smoothly cleared by using this function.

Operation

- When the brakes are applied, the throttle servo will pulse intermittently, will have the same effect as pumping the brakes in a full-size car
- The brake return amount, pulse cycle, and brake duty can be adjusted.
- By setting the brake mixing function (Mixing menu), it can also be set for the 2nd and 3rd (auxiliary channel) brake.

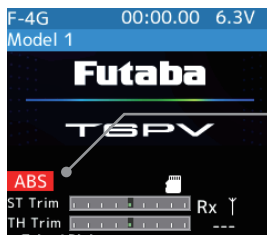
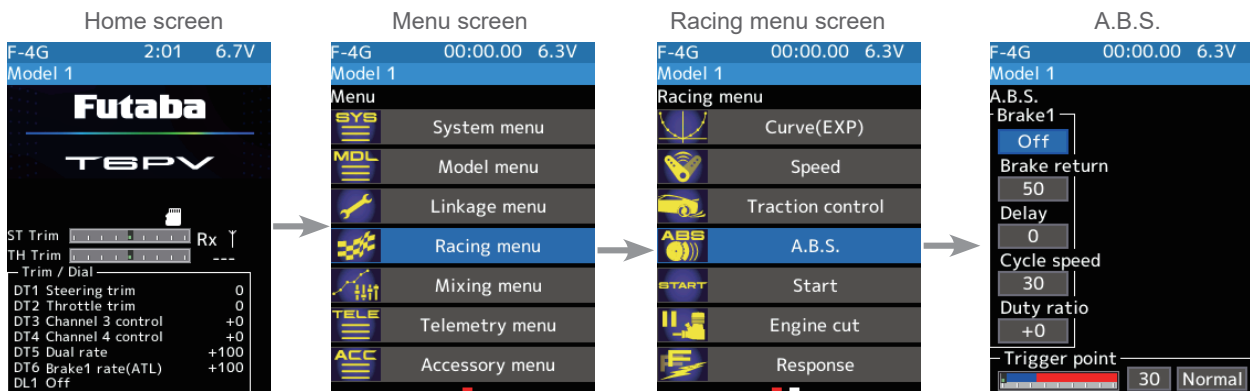
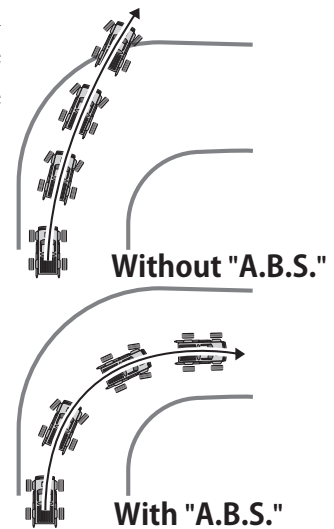

It is displayed in the home screen. When the A.B.S is ON.

- Mode: Function ON/OFF

ABS function ON/OFF setting. When using the ABS function, set to "ON".

- Brake return

Sets the rate at which the servo returns versus trigger operation for brake release. When set to 0%, the ABS function is not performed. When set to 50%, the servo returns 50% (1/2) of the trigger operation amount, and when set to 100%, the servo returns to the neutral position.

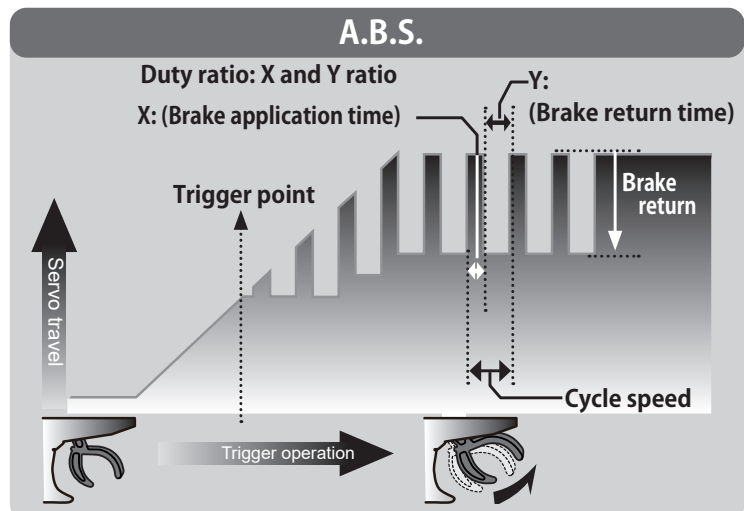



RACING MENU

- Delay

Sets the delay from brake operation to ABS operation. When set to 0%, the ABS function is activated without any delay. At 50%, the ABS function is activated after a delay of approximately 0.7-seconds and at 100%, the ABS function is activated after a delay of approximately 1.4-seconds.

- Cycle speed

The lower this setting, the faster the pulse speed. Set value, the quicker the pulse speed.

- Duty ratio

Sets the proportion of the time the brakes are applied, and the time the brakes are released by pulse operation. The ratio can be set to +4 ~ +0 ~ -4 in 9 steps.

- Trigger point

Sets the trigger point at which the ABS function begins to operate at brake operation.

When the trigger ratio was set to 100:0

When the trigger ratio (Linkage menu→Throttle mode) was set to 100:0, brake operation stops, and the servo does not operate even if the ABS function is set.

A.B.S. function adjustment

1

(Function ON/OFF)

Use the jog key to place the cursor on BRAKE ON/OFF and use the [+] or [-] button to select ON/OFF.

"OFF" :ABS function OFF

"ON" :ABS function ON

When using ABS function ON/OFF by switch, use the switch select function (Linkage menu) to set the switch to be used.

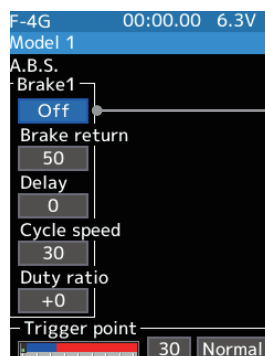

* Displays ON/OFF of the condition that ABS is working by throttle trigger operation.

2

("Brake return" amount adjustment)

Select the value with jog key of the [Brake return]. Use the [+] or [-] button to adjust the return amount.

"0": No return

"50": Return to the 50% position of the brake operation amount

"100": Return to the neutral position.

Adjustment buttons

- Adjust with the [+] or [-] button.
- Return to the initial value by press the [+] and [-] button simultaneously

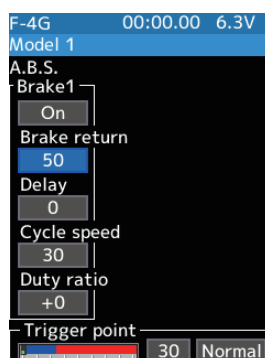
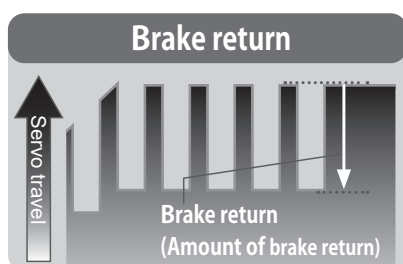

Return amount

0~50~100
Initial value: 50

The amount of brake return varies depending on the curve setting of the brake etc.



RACING MENU

3 ("Delay" amount setup)

Select the value with jog key of the [Delay]. Use the [+] or [-] button to adjust the delay amount.

- "0": A.B.S. function performed without any delay
- "50": A.B.S. function performed after an approximate 0.5-sec delay.
- "100": A.B.S. function performed after an approximate 1.0-sec delay.

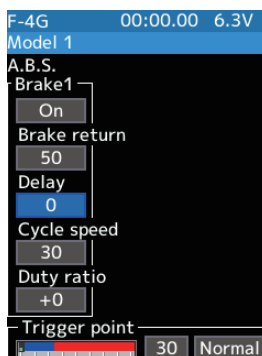

Adjustment buttons

- Adjust with the [+] or [-] button.
- Return to the initial value by press the [+] and [-] button simultaneously

Delay amount

0~ 100
Initial value: 0

4 ("Cycle speed" adjustment)

Select the value with jog key of the [Cycle speed]. Use the [+] or [-] button to adjust the cycle speed amount.

- The lower this setting, the faster the pulse speed. Set value, the quicker the pulse speed.

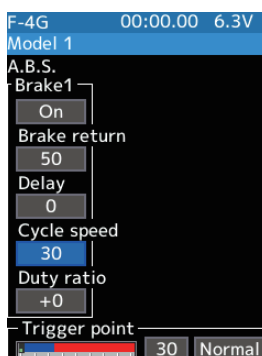

Adjustment buttons

- Adjust with the [+] or [-] button.
- Return to the initial value by press the [+] and [-] button simultaneously

Cycle speed amount

1~100
Initial value: 30

5 ("Duty ratio" setup)

Select the value with jog key of the [Duty ratio]. Use the [+] or [-] button to adjust the duty ratio amount.

- "-4": Brake application time becomes shortest. (Brakes lock with difficulty)
- "+4": Brake application time becomes longest (Brakes lock easily)

Adjustment buttons

- Adjust with the [+] or [-] button.
- Return to the initial value by press the [+] and [-] button simultaneously

Duty ratio amount

-4~+0~+4
Initial value: +0

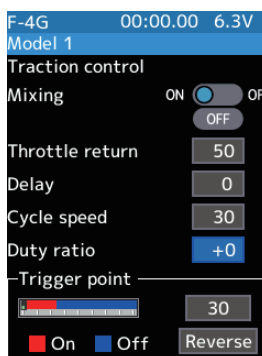
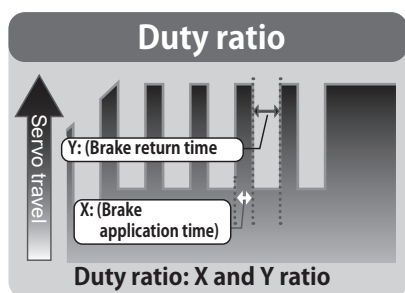



RACING MENU

6 ("Trigger point" setup)

Select the value with jog key of the [Trigger point]. Use the [+] or [-] button to adjust the operation point.

- Sets the throttle trigger position at which the A.B.S. function is performed. The number is the % display with the full brake position made 100.

Select [Normal] or [Reverse] to set the operating range.

"Normal": Neutral to trigger point is the range of motion.

"Reverse": The range from the trigger point to the full brake side is the operating range.

Adjustment buttons

- Adjust with the [+] or [-] button.
- Return to the initial value by press the [+] and [-] button simultaneously

Trigger point

5~95

Initial value: 30

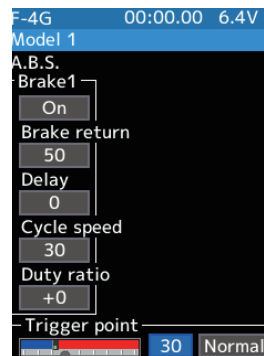
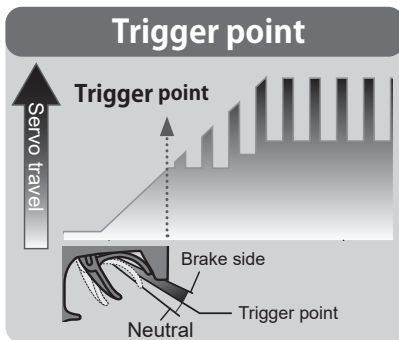

* Throttle trigger position

7 When finished, return to the Racing menu screen by pressing the END button, or press and hold the END button to return to the Home screen.

The 1/5 scale car and other independent brakes and ABS

ABS can be independently set for the brakes, which are controlled by the Brake 2 and Brake 3 (brake 2 and 3 are auxiliary channels). Brake mixing can be set under the mixing menu.

Brake 1, 2, 3 can be adjusted independently except for the trigger point of the setting item.

Brake mixing
Brake 2 "ON"

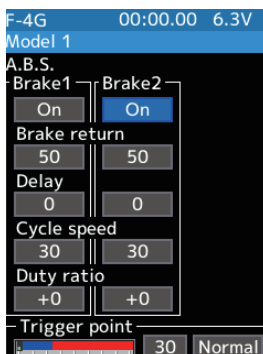

Brake mixing
Brake 3 "ON"

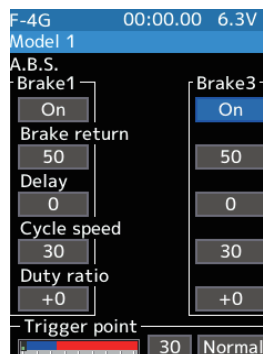

Brake mixing
Brake 2&3 "ON"

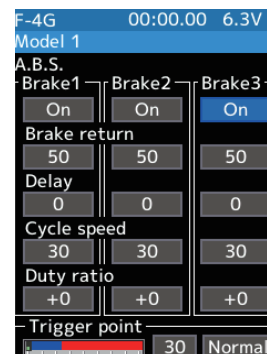



RACING MENU

Switch setting

Use switch the A.B.S. function ON/OFF.
See the switch select function. (Linkage menu)

Trim/Dial Setting

The brake return amount, delay amount, and cycle speed can be controlled with digital trim DT1 to DT6 or digital dial DL1, etc. with the trim/dial select function. (Linkage menu)

Example of A.B.S. function setting

(There will be a slight difference depending on the state of the linkage.)

Brake return: Approx. 30% (If this value is too high, the braking distance will increase.)

Cycle speed: 5~7

Duty ratio: 0 (When grip is low: - side, when grip is high: + side)

Delay: 10~15%

Trigger point: Approx. 70%

Steering mixing: Off

- When the wheels lock, or the car spins, when the brakes are applied fully.

Brake return: Increase from 30%

Duty ratio: Shift from 0 to - side (-1, -2, -3, -4)

Delay: Reduce the delay.

- When the braking effect is poor, and the braking distance is long when the brakes are applied fully.

Brake return: Decrease from 30%

Duty ratio: Shift from 0 to + side (+1, +2, +3, +4)

DLY: Increase the delay.



RACING MENU

START

Start

If the track is slippery and you begin to accelerate by pushing the trigger to full throttle, the car wheels will spin, and the car will not accelerate smoothly. When the Start function is activated, merely operating the throttle trigger slowly causes the throttle servo to automatically switch from the set throttle position to a preset point so that the tires do not lose their grip and the car accelerates smoothly.

Without the "Start" function

Wheels spin- Car does not accelerate



With the "Start" function

Tires grip the track firmly- Car accelerates



Operation

- When the throttle trigger is moved to the preset position (trigger point), the throttle servo moves to the preset position.
- When the throttle trigger is operated slowly so that the wheels will not spin, the car automatically accelerates to the set speed.
- This function is effective only for the first throttle trigger operation at starting. This function has to be activated before every start.
- When the throttle trigger is returned slightly, the Start function is automatically deactivated, and the set returns to normal throttle trigger operation.

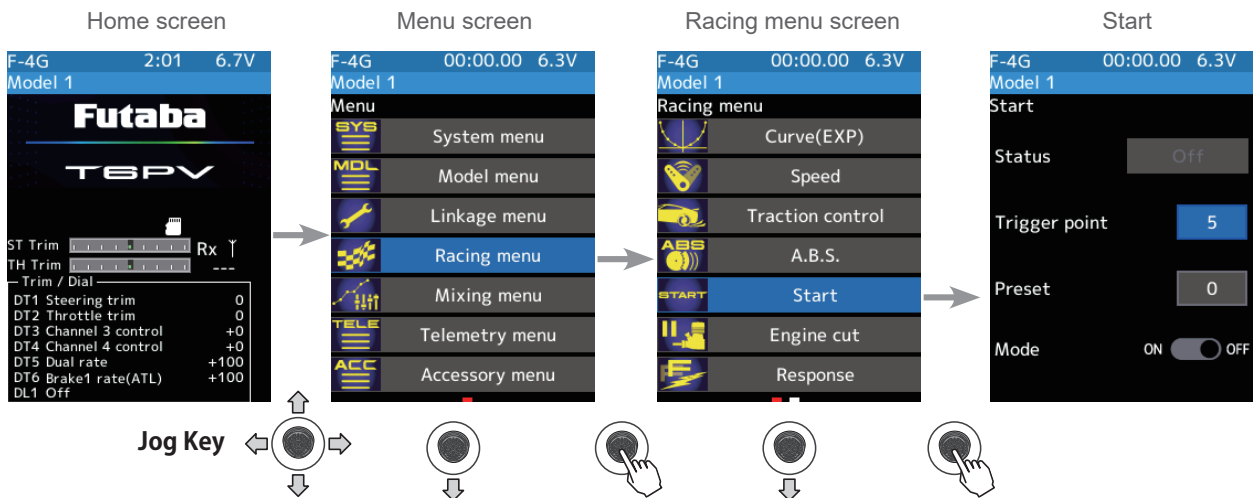

Start function adjustment

1 (Function ON/OFF)

Use the jog key to move the cursor to "Mode" ON/OFF. Use the [+] or [-] button to select ON/OFF.

"OFF": Start function OFF
"ON": Start function ON

The status display changes to [Ready] or [Active].

To enable the [Active] status with the switch, set the "Start switch" with the switch select function (Linkage menu).

Setting

- Use the [+] or [-] button to set (ON)/(OFF).

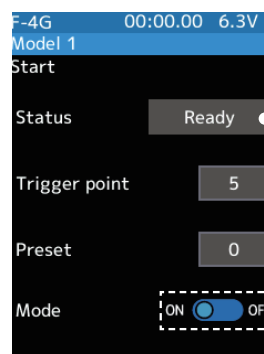

* The status display changes to [Active] or [Ready].



RACING MENU

- 2** ("Trigger point" setup)
Select the value with jog key of the [Trigger point]. Use the [+] or [-] button to adjust the operation point.

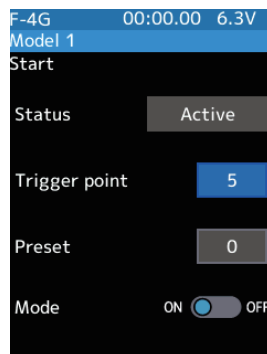

Adjustment buttons
- Adjust with the [+] or [-] button.
- Return to the initial value by press the [+] and [-] button simultaneously

Trigger point
5~95
Initial value: 5

- 3** ("Preset position" setup)
Select the value with jog key of the [Preset]. Use the [+] or [-] button to set the preset position of the throttle servo.

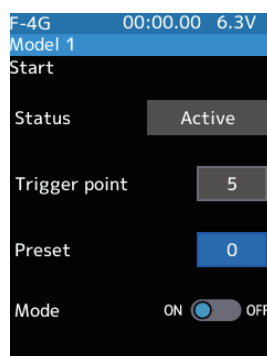

Adjust button
Adjust with the [+] or [-] button.
- Return to the initial value by press the [+] and [-] button simultaneously

Preset position
0~100
Initial value: 0

- 4** ("Ready" setting)
To set "Ready" again, when you select [OFF] under "Status" with the jog key and press it, the display will change to [Ready] and the device will wait for a trigger operation. Also, you can set the switch to be in the [Ready] state in the switch select function (Linkage menu).

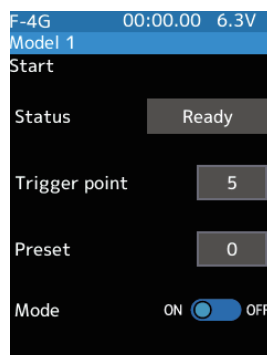

Restart
Select the [OFF] to [Ready]

- 5** When finished, return to the Racing menu screen by pressing the END button, or press and hold the END button to return to the Home screen.

In the [Ready] state, if the throttle trigger is operated to the position of the trigger position, the throttle servo moves to the servo operation position set with preset. It is canceled when the throttle trigger is returned.



RACING MENU



Engine cut

When the switch is pressed, the throttle servo will move to the preset position without regard to the throttle trigger position. This function is convenient when used to cut the engine of boats, etc. (The switch select function in Linkage menu)

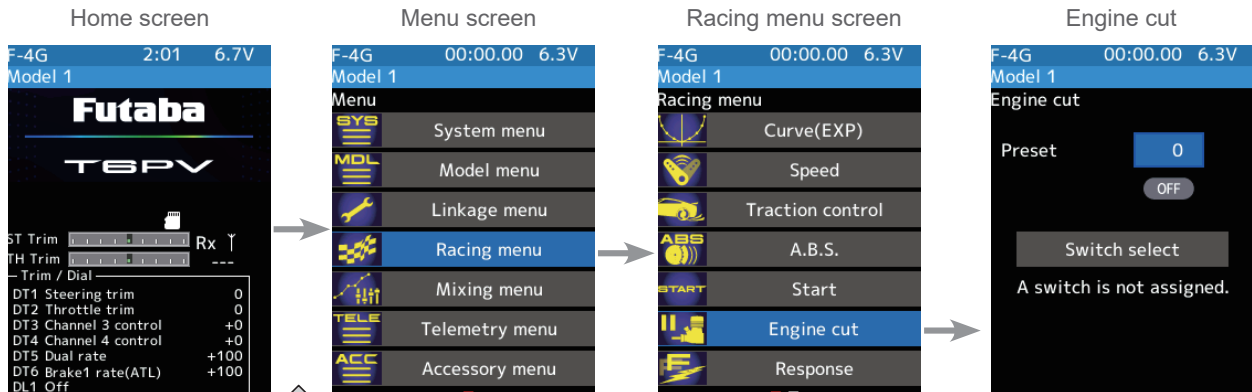

Jog Key

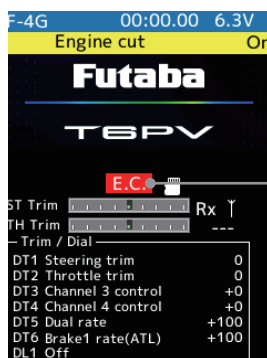

Engine cut ON/OFF is indicated on the home screen for a few seconds.

It is displayed in the home screen, when the engine cut is ON.

Warning display

If the power switch is turned on while the engine cut switch is on, an audible alarm will be heard. Immediately set the engine cut switch to OFF.

When the trigger ratio was set to 100:0

When the trigger ratio (Linkage menu→Throttle mode) is set to 100:0, the brake side function will not operate. The preset position set here is the linkage reference. Set the linkage so that the carburetor is fully closed in the preset adjustment range, and the engine stops. The full throttle position is set by end point function. Adjust the idling position with throttle trim.

Engine Cut function adjustment

(Preparation)

- Use the switch setting function to the "Switch select". (Linkage menu)
- When the switch is not set, "A switch is not assigned" is displayed. Select the [Switch select] to display the switch selection screen and set the switch.

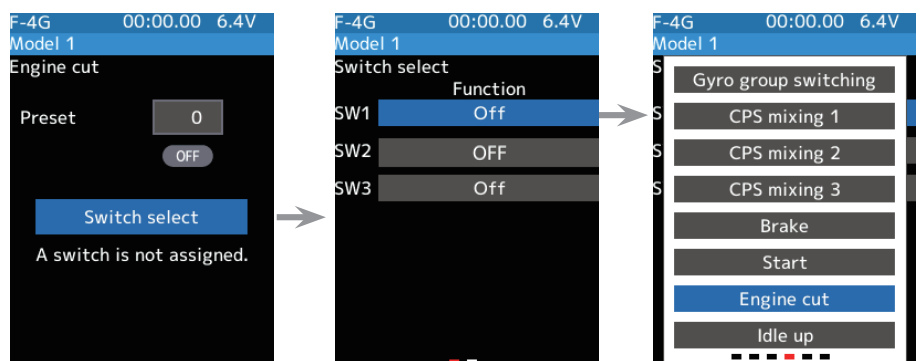

Example of setting to SW1



RACING MENU

1 (Preset position setup)

Select the value with jog key of the [Pre-set]. Use the [+] or [-] button to set the preset position of the throttle servo.

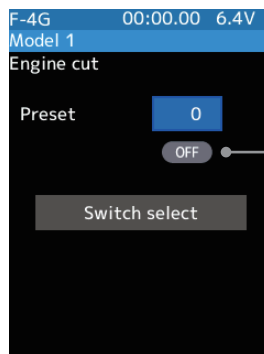

*Shows the ON/OFF state

Adjust button

Adjust with the [+] or [-] button.
- Return to the initial value by press the [+] and [-] button simultaneously

Preset position

0~100

Initial value: 0

- ## 2
- When finished, return to the Linkage menu screen by pressing the END button, or press and hold the END button to return to the Home screen.

Trim/Dial Setting

The function select trim/dial function can control the engine cut preset position with the digital dial or digital trim (Linkage menu).

The throttle servo operating position (preset position) set by this setting is unrelated to the environment of other functions. Maximum to minimum servo travel can be set. However, the reverse function setting is enabled.

Caution

⚠ Always operate carefully before using this function.

When push switch, or trigger switch with preset function set is in the ON state, the servo (motor controller) is locked in the preset position and does not operate even if the throttle trigger is operated. If the servo was operated at the wrong setting, you may lose control of the car (boat).



RACING MENU



Response

It is a function to make the response mild. Use when the servo response is too sensitive.

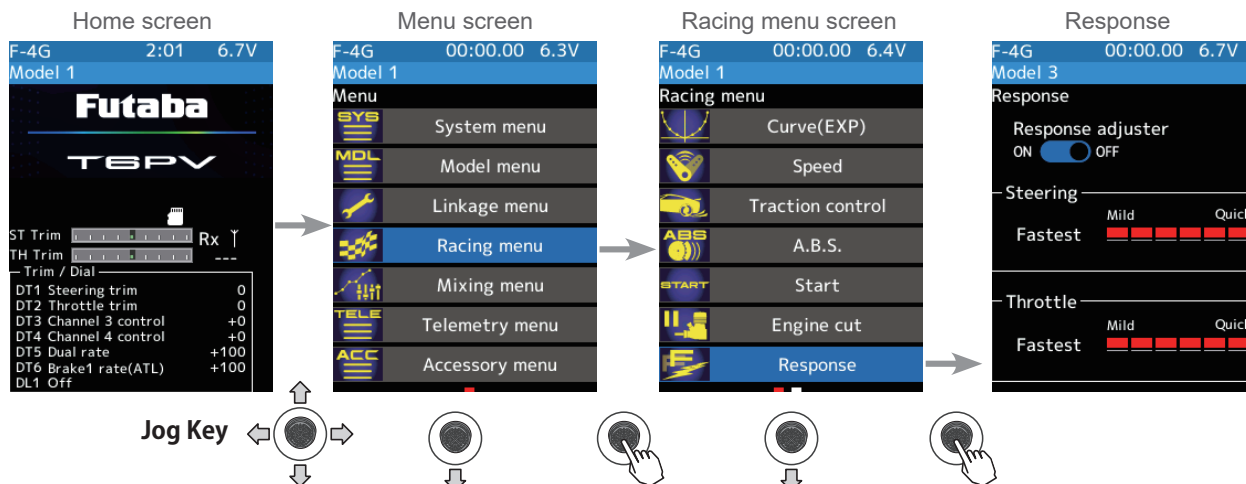

Response function adjustment

- 1 (Function ON/OFF)
Use the jog key to move the cursor to "Response adjuster" ON/OFF. Use the [+] or [-] button to select ON/OFF.

"OFF": Response function OFF (Response Fastest)

"ON": Response function ON

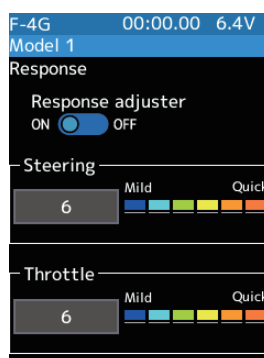

Setting

- Use the [+] or [-] button to set (ON) (OFF).

- 2 Select the value with jog key of the [Steering]. Use the [+] or [-] button to adjust the response.



Adjust button

Adjust with the [+] or [-] button.
- Return to the initial value by press the [+] and [-] button simultaneously

Response

(Mild)1-6 (Quick)
Initial value: 6 (Quick)

- 3 Select the value with jog key of the [Throttle]. Use the [+] or [-] button to adjust the response.

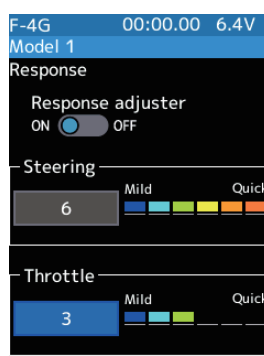

Adjust button

Adjust with the [+] or [-] button.
- Return to the initial value by press the [+] and [-] button simultaneously

Response

(Mild)1-6 (Quick)
Initial value: 6 (Quick)

When finished, return to the Racing menu screen by pressing the END button, or press and hold the END button to return to the Home screen.



RACING MENU



Drag racing

Trans-Brake

The Trans-Brake allows the engine to develop full power without that power being transmitted into the drive-train. This function can be used in a drag racing situation, where the driver can use the trans-brake to assist in the staging process.

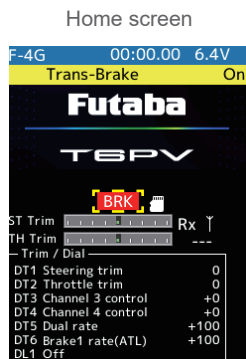
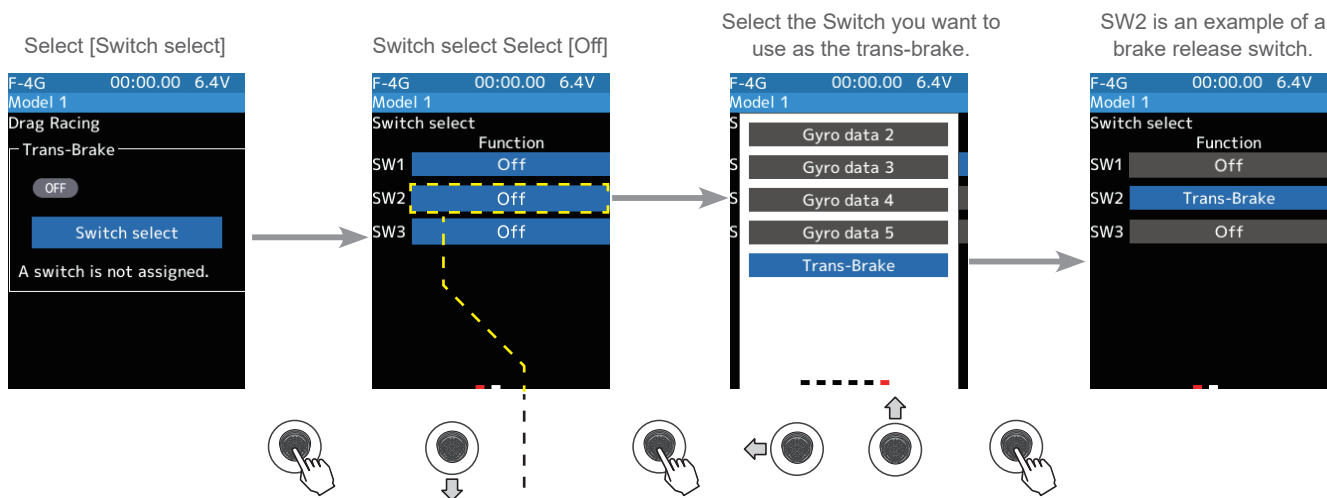
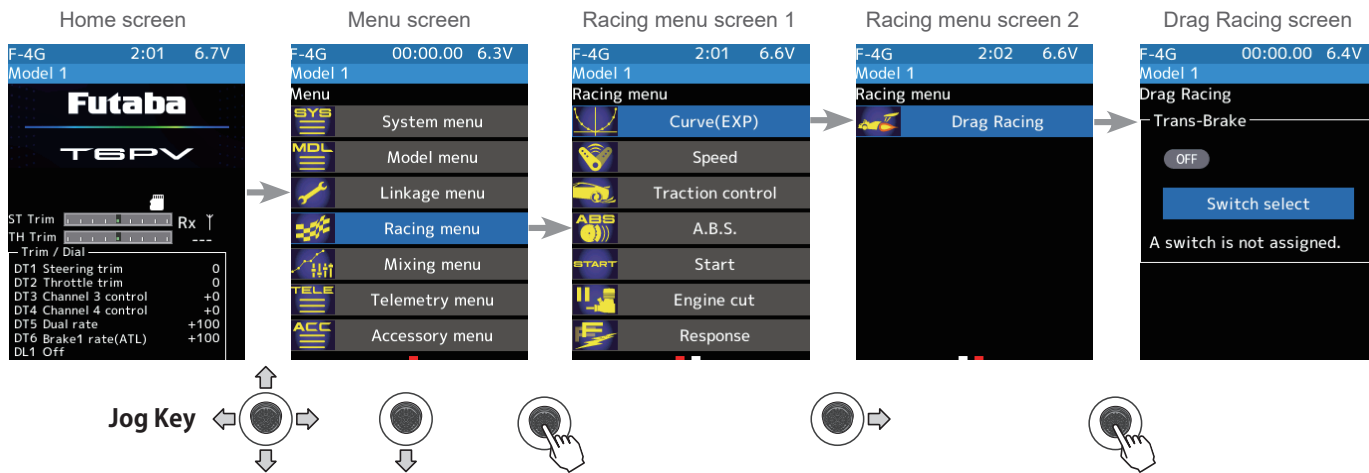

SW2 example

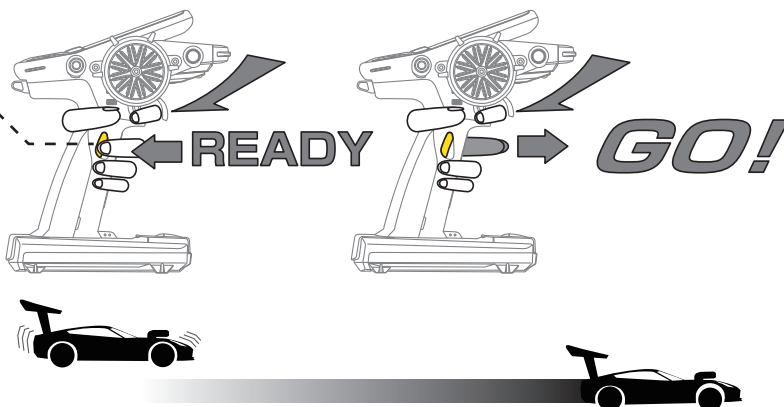

When the switch is activated, Trans-brake is visible as "BRK" on the main screen. You can now modulate the throttle and the car will not move until the Trans brake switch is released.

Steering mixing

This mixing function uses two servos to individually control the left and right steering. Left and right steering can be set independently, so smooth cornering is possible. By using the "Steering mixing rate" function, the motions of the servos on the left and right sides of the steering can be adjusted at the same time. The right side steering servo or the left side steering servo connects to receiver channel 1, and the other side connects to receiver auxiliary channels. The channel to which the left and right servo connect is not specified. After the left and right servos are adjusted individually, Ackerman can also be adjusted by the Ackerman rate. Also, the left and right steering are operated in the opposite direction by the switch. An emergency brake function by steering can also be set.

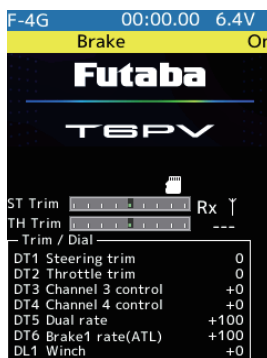
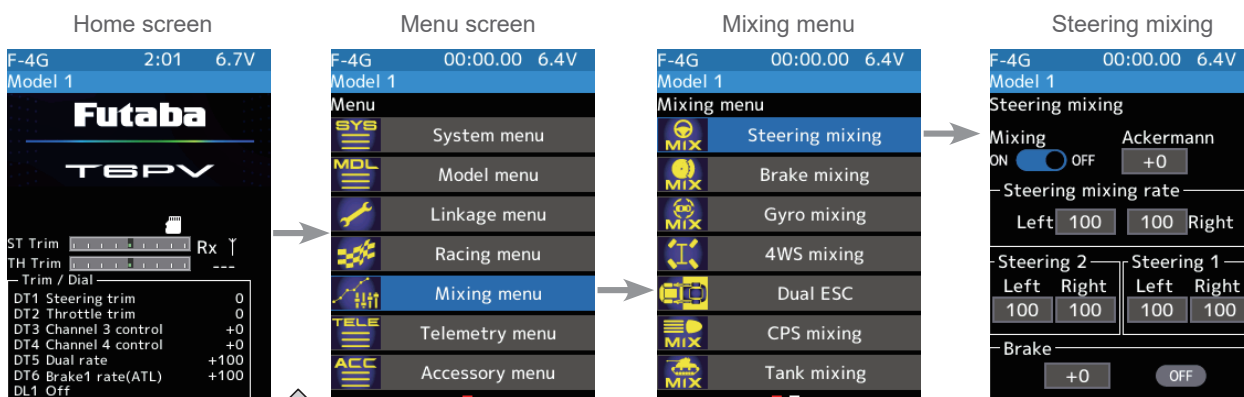

Steering brake ON/OFF is indicated on the home screen for a few seconds.

If the power switch is turned on while the steering brake switch is on, an audible alarm will be heard. Immediately set the steering brake switch to OFF.

The mixing function is assigned to auxiliary channels used by another mixing cannot be used. When the number of channels is insufficient, cancel the other mixing.

Steering mixing adjustment

- (Function ON/OFF)
Use the jog key to move the cursor to "Mixing" ON/OFF. Use the [+] or [-] button to select ON/OFF.

"OFF": Mixing function OFF
"ON": Mixing function ON

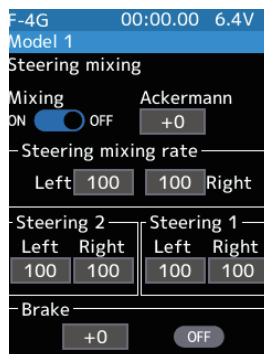

Setting
- Use the [+] or [-] button to set (ON)/(OFF).

2 (Channel setup)

The channel list screen used for steering 2 is displayed. Press jog key the auxiliary channel that connected the servo of steering 2.

- When all channels are in use, a screen saying "No assignable channel" is displayed, please turn off other mixing and select an unused channel. You can check the mixing used on the channel setting screen (Linkage menu).
- T6PV can also be used for steering 2 by setting the throttle to other auxiliary channels setting function and making the Ch.2 assignable channel (Linkage menu).

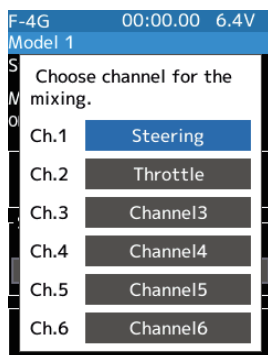

The number of channels varies depending on the selected system.

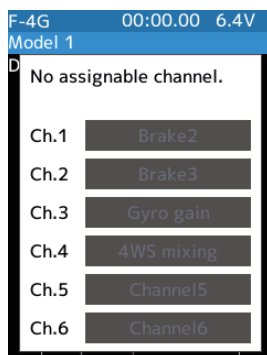

If there is no assignable channel, Select the [Close]. Turn off other mixing and make assignable channels.

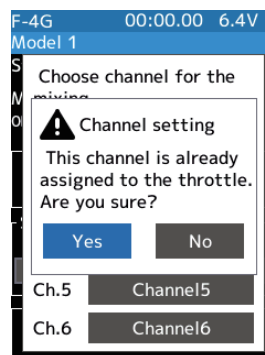

To set the throttle to another auxiliary channel and use it for steering 2, Select the [Yes]. To cancel, [No] is press jog key.

3 (Steering 1 servo steering angle adjustment)

Select the value with jog key of the "Steering 1" [Left] or [Right]. Turn the steering wheel fully to the left or right and adjust the left and right steering amounts by [+] or [-] button.

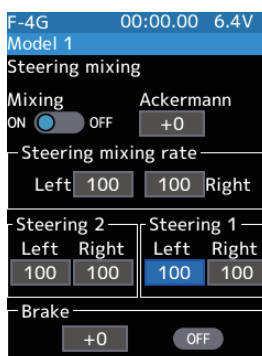

Adjustment buttons

- Adjust with the [+] or [-] button.
- Return to the initial value by press the [+] and [-] button simultaneously

Steering 1 rate (Left/Right)

0~140
Initial value: 100

4 (Steering 2 servo steering angle adjustment)

Select the value with jog key of the "Steering 2" [Left] or [Right]. Turn the steering wheel fully to the left or right and adjust the left and right steering amounts by [+] or [-] button.

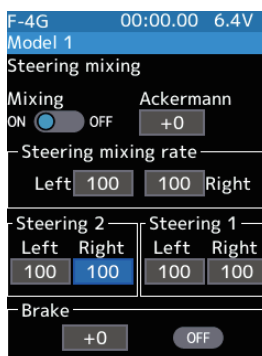

Adjustment buttons

- Adjust with the [+] or [-] button.
- Return to the initial value by press the [+] and [-] button simultaneously

Steering 2 rate (Left/Right)

0~140
Initial value: 100

- 5** (Steering mixing rate adjustment)
 Select the value with jog key of the "Steering mixing rate" [Left] or [Right]. Adjust each of the left/right steering angles using the [+] or [-] button.



Adjustment buttons

- Adjust with the [+] or [-] button.
- Return to the initial value by press the [+] and [-] button simultaneously

Steering mix rate

0~100
 Initial value: 100

- 6** (Ackerman adjustment)
 Select the value with jog key of the "Ackerman rate". Adjust the Ackerman by [+] or [-] button.



Adjustment buttons

- Adjust with the [+] or [-] button.
- Return to the initial value by press the [+] and [-] button simultaneously

Steering mix rate

-100~+0~+100
 Initial value: +0

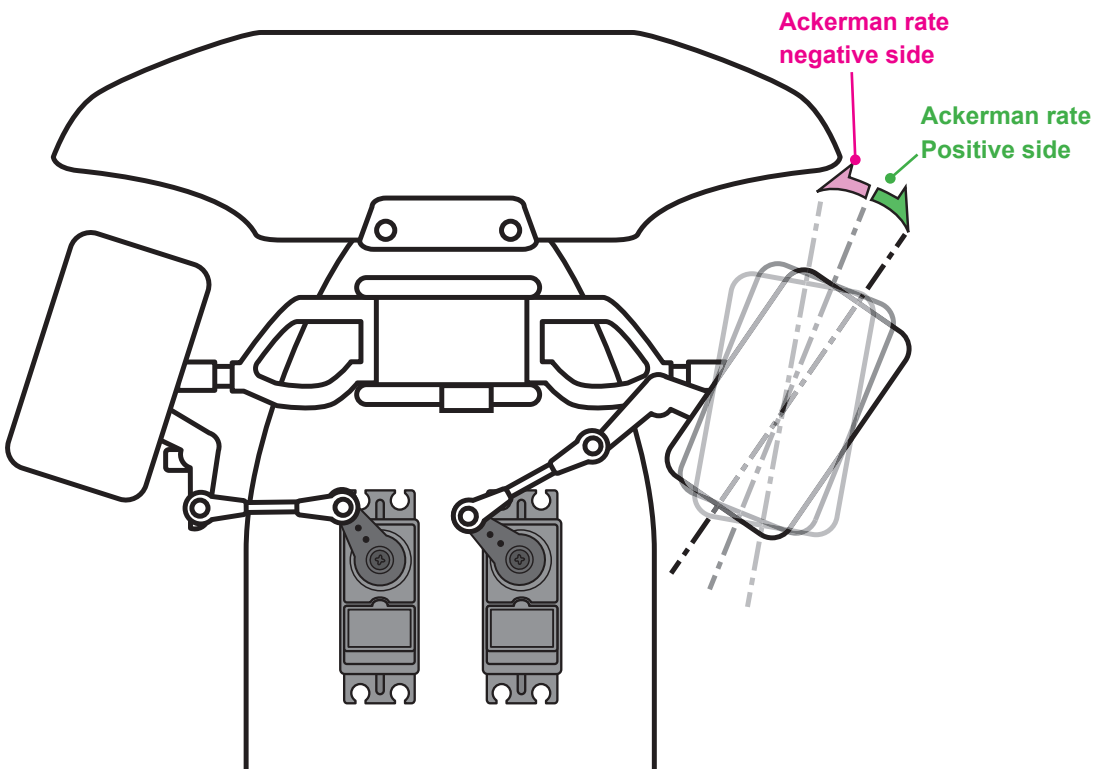

7 (Steering brake) (Preparations)

When using this function, set the switch with the "Switch select" function (Linkage menu). Select the value with jog key of the "Brake rate". adjust the steering 1/2 operation position by [+] or [-] button.

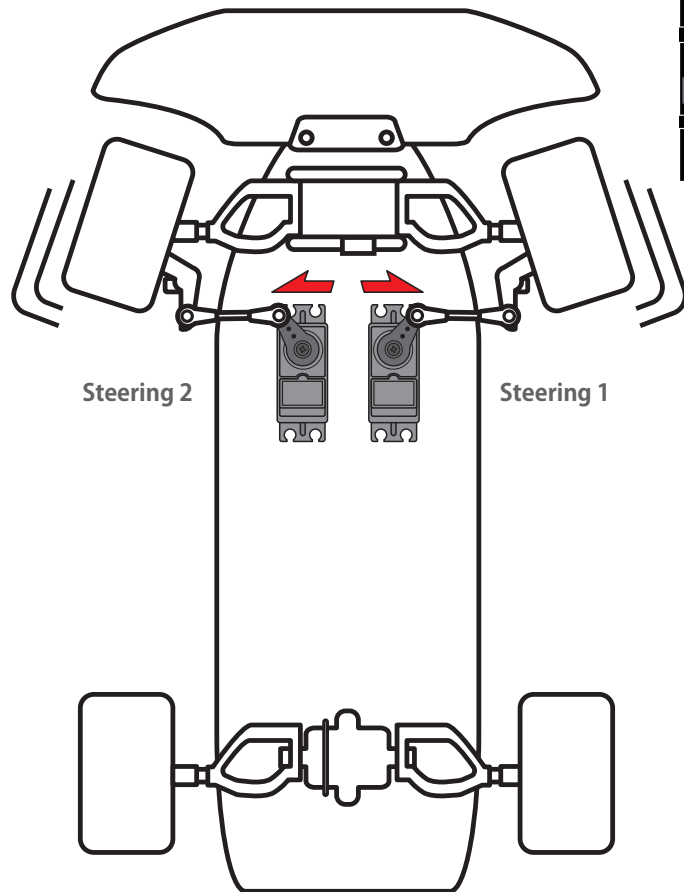
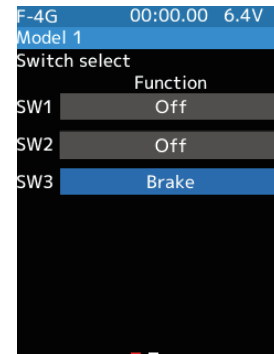
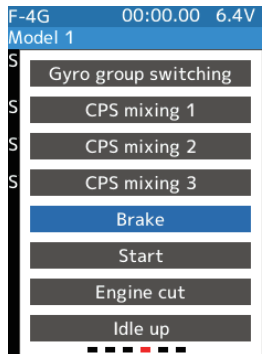

Adjustment buttons

- Adjust with the [+] or [-] button.
- Return to the initial value by press the [+] and [-] button simultaneously

Brake rate

-100~+0~+100
Initial value: +0

8 When finished, return to the Racing menu screen screen by pressing the END button, or press and hold the END button to return to the Home screen.

Trim/Dial Setting

The Ackerman rate adjustment can be controlled with digital trim DT1 to DT6 or digital dial DL1 etc. with the trim/dial select function. (Linkage menu)

Brake mixing

This function is used when the front and rear brakes must be adjusted independently such as a 1/5 scale GP car. This mixing uses the 2nd channel for the rear brakes and the auxiliary channel for the front brakes, or controls the front brakes with the auxiliary channel servos, or controls the 2nd channel by the independent throttle and controls the rear and front brakes with the auxiliary channel. Also, mixing, which varies the auxiliary channels brake rate in proportion to steering operation is possible.

Operation

- When braking, mixing is applied from brake 1 to brake 2 and brake 3.
- Brake 2 and brake 3 amount, brake 1,2,3 delay, and Brake 2 and brake 3 EXP and ABS can be set.
- Steering mixing, which varies front brakes brake 2,3 (auxiliary channels) matched to the steering operation, can be set. Front brake 2,3 (auxiliary channels) can be individually weakened according to the steering left or right operation amount.

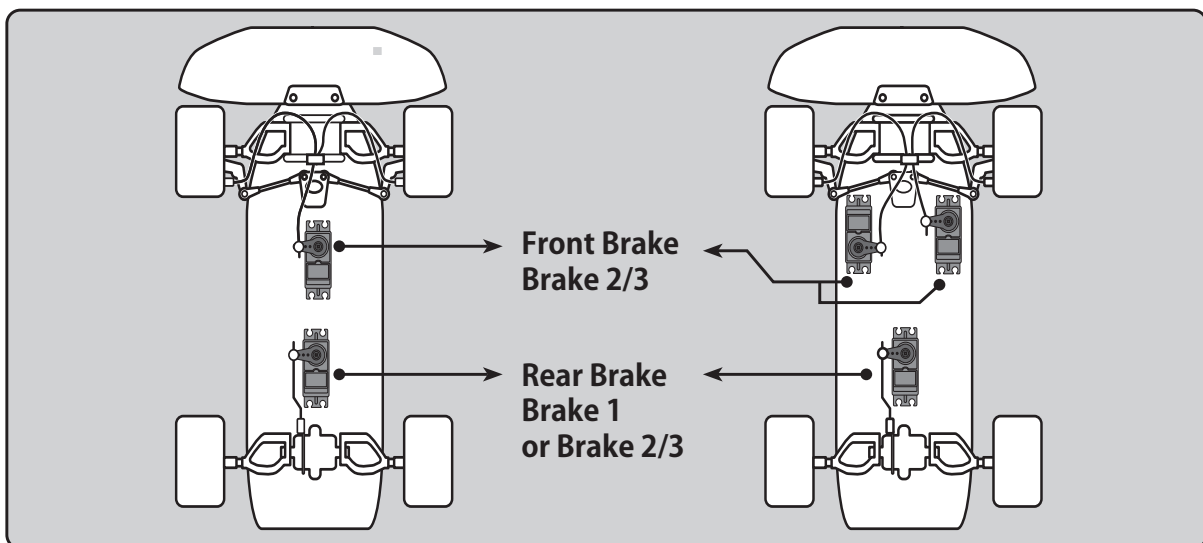

When the trigger ratio was set to 100:0

When the trigger ratio (Linkage menu→Throttle mode) was set to 100:0, brake operation stops. When using brake mixing, set the trigger mode to 70:30/60:40/50:50.

Auxiliary channels A.B.S.

Brake mixing can also use the A.B.S. function for 2nd and 3rd brakes. Except for trigger point and steering mixing, it can be set exclusively for the 2nd and 3rd brakes side. Even if the A.B.S. function on the 1st brake (2nd channel) side is OFF, you can also use the A. B. S. function on the 2nd and 3rd brakes side alone. You can set the ON/OFF of the A.B.S. (brake 2, 3) function with the switch select function (Linkage menu).

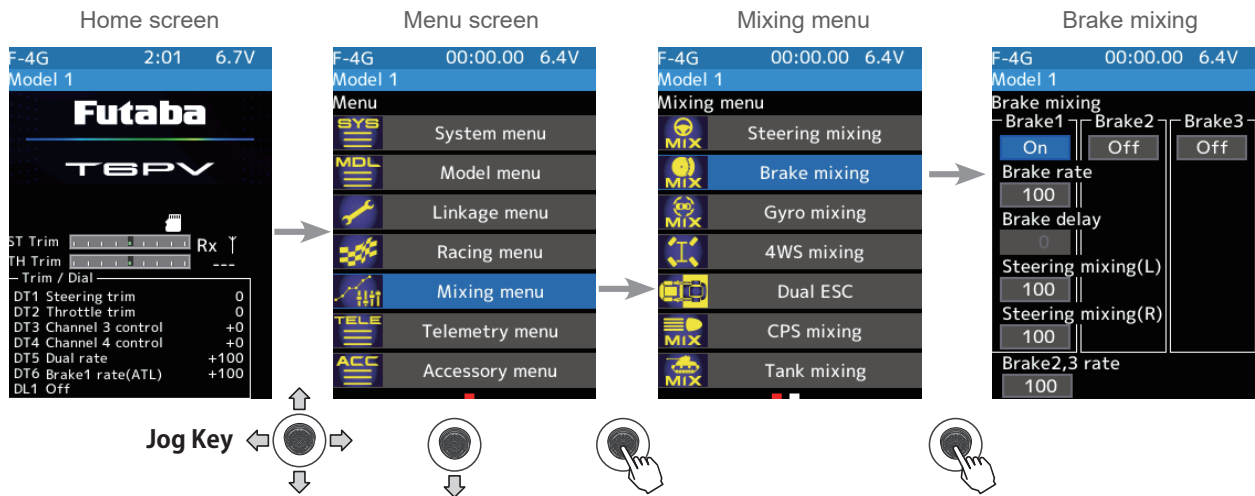

Brake mixing ON

Brake mixing Brake 2 "ON"	Brake mixing Brake 3 "ON"	Brake mixing Brake 2&3 "ON"

The mixing function is assigned to auxiliary channels used by another mixing cannot be used. When the number of channels is insufficient, cancel the other mixing.

Steering mixing adjustment

- (Function ON/OFF)
Use the jog key to move the cursor to "Mixing" ON/OFF. Use the [+] or [-] button to select ON/OFF.

"OFF": Mixing function OFF
"ON": Mixing function ON

Setting
- Use the [+] or [-] button to set (ON)/(OFF).



2 (Channel setup)

The channel list screen used for brake 2 or brake 3 is displayed. Press jog key the auxiliary channel that connected the servo of brake 2 or brake 3.

- When all channels are in use, a screen saying "No assignable channel" is displayed, please turn off other mixing and make an unused channel. You can check the mixing used on the channel setting screen (Linkage menu).
- T6PV can also be used for brake 2 or 3 by setting the steering to other auxiliary channels with the channel setting function and making the Ch.1 assignable channel (Linkage menu).

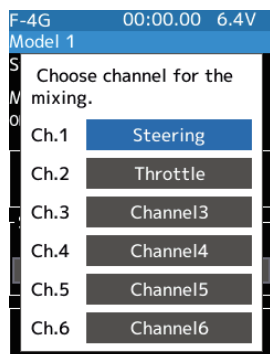

The number of channels varies depending on the selected system.

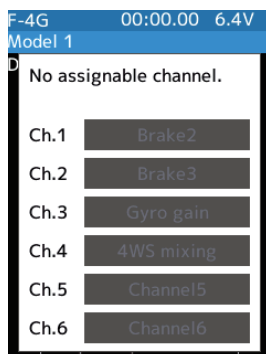

If there is no assignable channel, Select the [Close]. Turn off other mixing and make assignable channels.

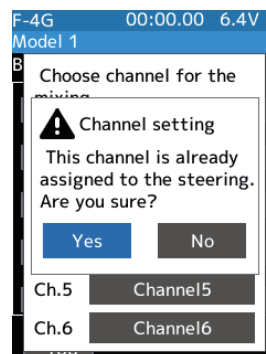

To set the steering to another auxiliary channel and use it for brake 2 or 3, Select the [Yes]. To cancel, [No] is press jog key.

3 (Brake 2 & 3 rate)

Select the value with jog key of the "Brake 2 or 3" [Brake rate]. Use the [+] or [-] button to adjust the brake rate amount.

- When adjusting the brake amount of both brakes after individually adjusting the Brake 2 and Brake 3, select "Brake 2,3 rate".
- The brake 1 rate is linked with the throttle channel (ATL) setting.



Adjustment buttons

- Adjust with the [+] or [-] button.
- Return to the initial value by press the [+] and [-] button simultaneously

Brake rate

0~100
Initial value: 100

4 (Delay amount setup)

Select the value with jog key of the "Brake 1 or 2,3" [Brake delay]. Use the [+] or [-] button to adjust the delay amount.

- Since a delay at all the brakes is dangerous, a delay is not applied to the brake to be adjusted last.
- For example, when brakes 1, 2, and 3 are all used, when a delay is applied to brakes 2 and 3, a delay cannot be applied to brake 1. When a delay must be applied to brake 1, the brake 2 or brake 3 delay must be set to "0".

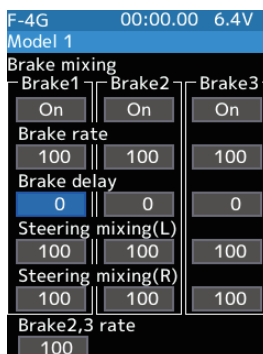

5 (Steering mixing)

Use this function when you want to soften the brakes when the steering is operated.

Select the value with jog key of the "Brake 1 or 2,3" [Left]. Use the [+] or [-] button to adjust the brake amount.

Select the value with jog key of the "Brake 1 or 2,3"[Right]. Use the [+] or [-] button to adjust the brake amount. The smaller the value, the weaker the front brakes. Set value "100" is the state in which steering mixing is not performed.

- The mixing amount can be adjusted in a range from 0 to 100.



Adjustment buttons

- Adjust with the [+] or [-] button.
- Return to the initial value by press the [+] and [-] button simultaneously

Brake rate (Mixing)

0~100
Initial value: 100



- ## 6
- When finished, return to the Mixing menu screen screen by pressing the END button, or press and hold the END button to return to the Home screen.

Trim/Dial Setting

The trim/dial select function can control the brake 1,2,3 rate, delay amount, and EXP setting using the digital dial or digital trim. (Linkage menu)

Gyro mixing

This function is a remote gain function which adjusts the sensitivity of the Futaba car rate gyro at the T6PV side, and is mixing that uses the auxiliary channels to improve the gyro sensitivity. When using the T6PV by switching the AVCS and normal modes, use SW with the switch select function (Linkage menu).

For a description of the "Car rate gyro" mounting method and handling, refer to the rate gyro instruction manual.

When using UR/SR mode compatible gyro in UR/SR mode channel, set both steering input and gyro sensitivity input channel to UR/SR mode. If either one is in normal mode, the gyro will not operate properly.

AVCS/NORMAL Modes

The gyro has two operating modes: NORMAL mode and AVCS mode. In the AVCS mode, the angle is controlled simultaneously with NORMAL mode rate control (swing speed). The AVCS mode increases straight running stability more than that of the NORMAL mode. Because the feel of operation is different, choose your favorite mode.

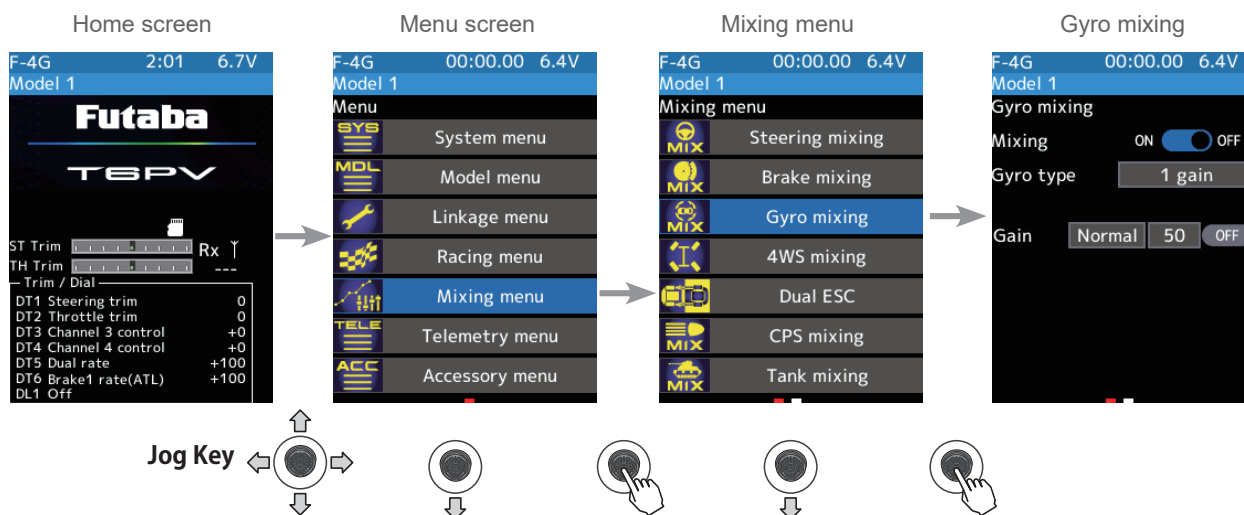

The mixing function is assigned to auxiliary channels used by another mixing cannot be used. When the number of channels is insufficient, cancel the other mixing.

Gyro mixing adjustment

(Preparation)

- Refer to the gyro instruction manual and connect the gyro to the receiver. When using remote gain, connect gyro sensitivity adjustment to the auxiliary channels of the receiver.
- When using gyro mixing by switching between the NORM (normal) and AVCS modes, use the switch select function (Linkage menu) to set the switch to be used.

1 (Function ON/OFF)

Use the jog key to move the cursor to "Mixing" ON/OFF. Use the [+] or [-] button to select ON/OFF.

"OFF": Mixing function OFF
 "ON": Mixing function ON

Setting

- Use the [+] or [-] button to set (ON)/(OFF).



2 (Channel setup)

The channel list screen used for the gain steering channel is displayed. Press jog key the auxiliary channel that connected the gain steering channel.

- When all channels are in use, a screen saying "No assignable channel" is displayed, please turn off other mixing and make an unused channel. You can check the mixing used on the channel setting screen (Linkage menu).

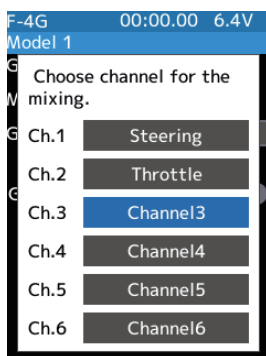

The number of channels varies depending on the selected system.

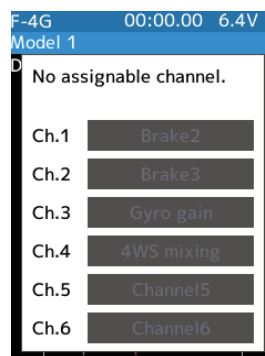

If there is no assignable channel, Select the [Close]. Turn off other mixing and make assignable channels.

3 (Gyro mixing type selection)
Use the jog key to move the cursor to Gyro type. Use the [+] or [-] button to select [1 gain], [2 gain] or [4 gain].

"1 gain" :One mode only
"2 gain" :Switching Gyro gain 1 and Gyro gain 2
"4 gain" :Set 4 Gyro gains.
2 groups of 2 gains can be set in one group.
Set the switch to change the group and the switch to change the gain in the group. (Use to 2 switch)

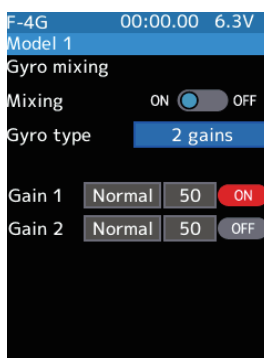

Can be switch between groups 1 and 2 with the group change switch.



Setting

- Press jog key Gain type.
1 gain/2 gain/4 gain

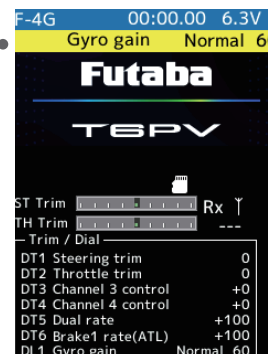

When changing the gain with the switch, indicated on the home screen for a few seconds.

* Display the current gyro gain.

4 (Gyro gain adjustment)
Select the value with jog key of each [Gain]. Use the [+] or [-] button to adjust the gain rate amount.

Place the cursor on Normal or AVCS and use the [+] or [-] button to select.



Adjustment buttons

- Adjust with the [+] or [-] button.
- Return to the initial value by press the [+] and [-] button simultaneously

Gyro gain

Normal: 0~120
AVCS: 0~120
Initial value: Normal 50

5 When finished, return to the Mixing menu screen screen by pressing the END button, or press and hold the END button to return to the Home screen.

Trim/Dial Setting

The gain amount can be adjusted by using the trim/dial select function. (Linkage menu)



4WS mixing

This function can be used with crawlers and other 4WS type vehicles. It is mixing that uses the 1st channel to control front side steering and the auxiliary channel to control rear side steering.

A method of specifying directly for each type of opposite phase (only on the in-phase side), reverse phase, in-phase side and rear side by selecting SW in the "Switch select" function (Linkage menu). And, it is possible to switch in order.

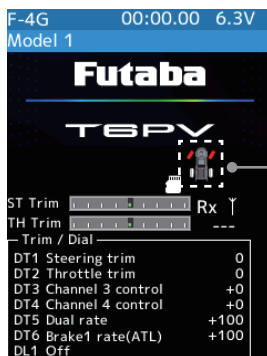
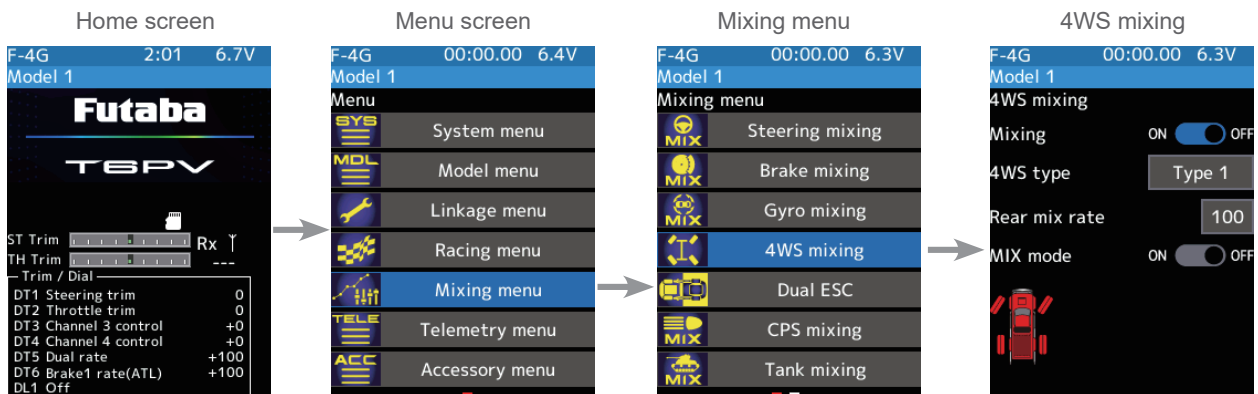

When the mode is activated by a switch, indicated on the home screen for a few seconds.

Display the current 4WS type.

The mixing function is assigned to auxiliary channels used by another mixing cannot be used. When the number of channels is insufficient, cancel the other mixing.

4WS mixing adjustment

(Preparation)

- Since this function is used by switching the type of 4WS with a switch, the switch used by the switch select function (Linkage menu) is set.

1

(Function ON/OFF)

Use the jog key to move the cursor to "Mixing" ON/OFF. Use the ± button to select ON/OFF.

- "OFF": Mixing function OFF
- "ON": Mixing function ON

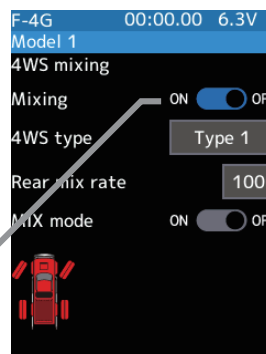
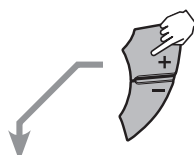

Setting

- Use the [+] or [-] button to set (ON)/(OFF).

2 (Channel setup)

The channel list screen used for rear steering is displayed. Press jog key the auxiliary channel that connected the servo of rear steering.

- When all channels are in use, a screen saying "No assignable channel" is displayed, please turn off other mixing and make an unused channel. You can check the mixing used on the channel setting screen (Linkage menu).
- T6PV can also be used for rear steering by setting the throttle to other auxiliary channels setting function and making the Ch.2 assignable channel (Linkage menu).



The number of channels varies depending on the selected system.

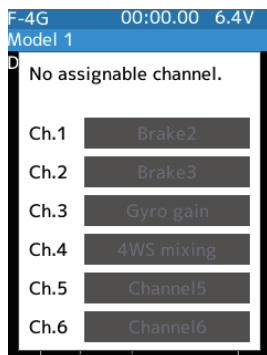

If there is no assignable channel, Select the [Close]. Turn off other mixing and make assignable channels.

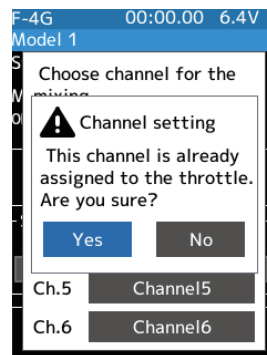

To set the throttle to another auxiliary channel and use it for steering 2, Select the [Yes]. To cancel, [No] is press jog key.

3 (4WS type selection)

Use the Jog key to move the cursor to [4WS type]. Use the [+] or [-] button to select [Type 1], [Type 2], [Type 3] or [Type 4].

"Type 1": Function OFF (front only)

"Type 2": Front side only, reverse phase switching

"Type 3": Front side only, reverse phase and same phase switching

"Type 4": Front side only, reverse phase, same phase, and rear side only switching

Setting

- Press [+] or [-] button 4WS type.
Type 1/Type 2/Type 3/Type 4

Switched in the order shown in the figure below by the assigned switch.

Type 2
Front side only, Reverse phase switching



Type 3
Front side only, Reverse phase and same phase switching

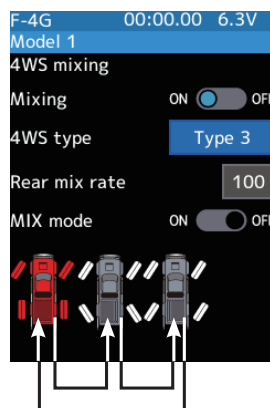

Type 4
Front side only, reverse phase, same phase, and rear side only switching

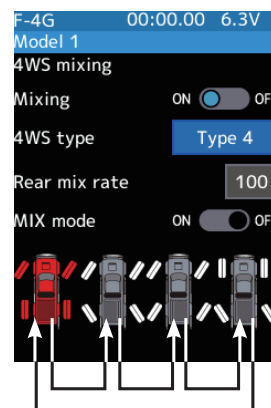

- 4** (Rear side travel adjustment)
 Select the value with jog key of the [Rear mix rate]. Use the [+] or [-] button to adjust the rear side travel amount.



Adjustment buttons

- Adjust with the [+] or [-] button.
- Return to the initial value by press the [+] and [-] button simultaneously

Rear rate (Rear mix rate)

0~100
 Initial value:100

- 5** (Mix mode setting)
 Use the jog key to move the cursor to "MIX mode" ON/OFF. Use the [+] or [-] button to select ON/OFF.

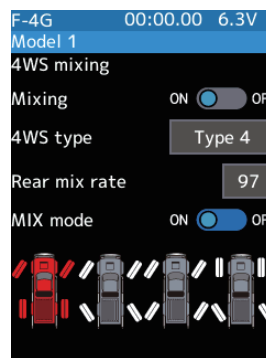

Setting

- Use the [+] or [-] button to set (ON)/(OFF).

"OFF": The EXP function of the 1st CH and other settings are not mixed.

"ON": The EXP function of the 1st CH and other settings are mixed.

- 6** When finished, return to the Mixing menu screen by pressing the END button, or press and hold the END button to return to the Home screen.

Trim/Dial Setting

The mixing amount can be adjusted by using the trim/dial select function. (Linkage menu)



Dual ESC

This function is mixing two ESCs used with crawlers and other 4WD type vehicles and uses the 2nd channel to control the rear motor controller and the auxiliary channel to control the front motor controller.

Front drive only, rear drive only, and both front and rear drive (4WD) switching can be performed by trim dial or by setting a switch for each mode.

Use a 50:50 trigger ratio setting. (Linkage menu→Throttle mode).

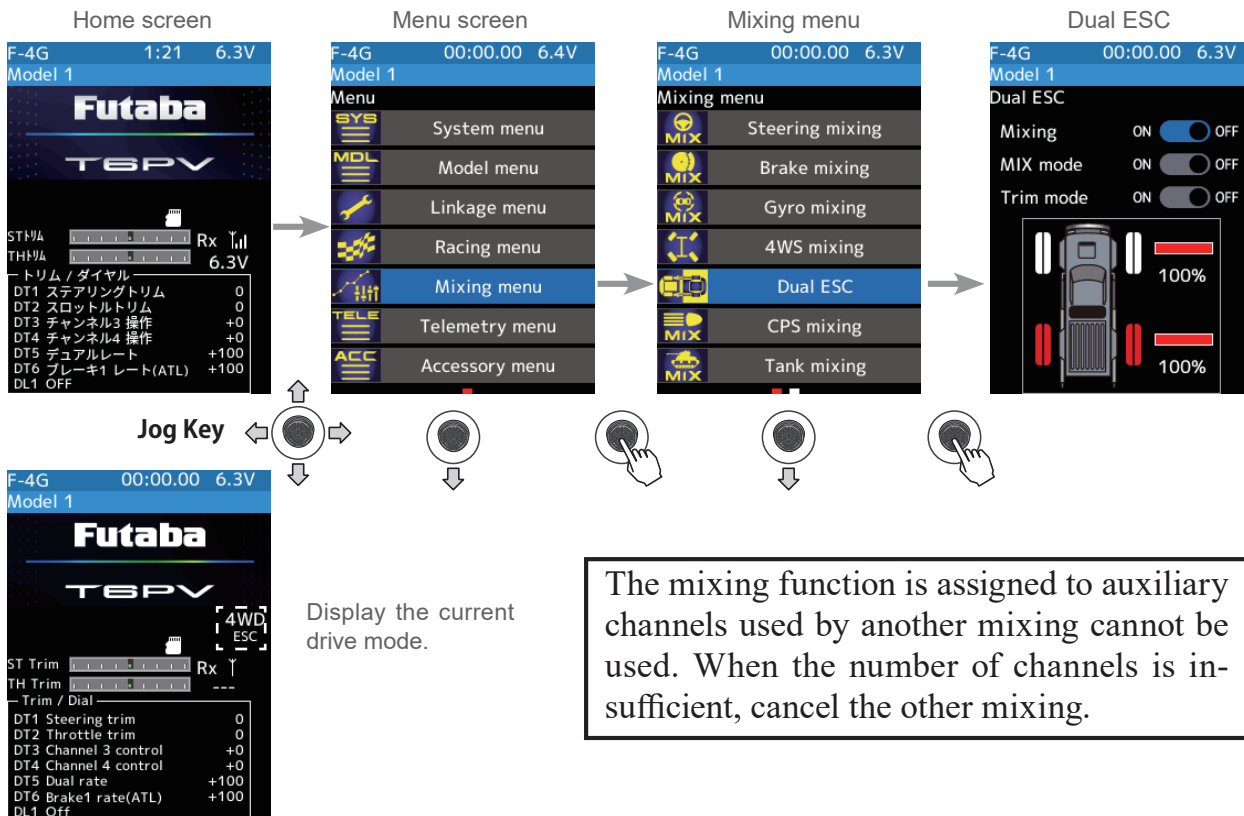

Dual ESC mixing adjustment

(Preparation)

- This function has 2 methods. One method is used by switching the drive type (4WD/front/rear) by one digital trim/dial. The other method performs switching by assigning a switch to each mode (4WD/front/rear). Both methods are set from among DL1 and DT1 to DT6 by the "Trim/Dial select" function.

1 (Function ON/OFF)

Use the jog key to move the cursor to "Mixing" ON/OFF. Use the [+] or [-] button to select ON/OFF.

"OFF": Mixing function OFF
 "ON": Mixing function ON

When switching by one digital trim is set, the set switch performs switching as shown below.

Front-drive ⇄ 4WD ⇄ Rear-drive

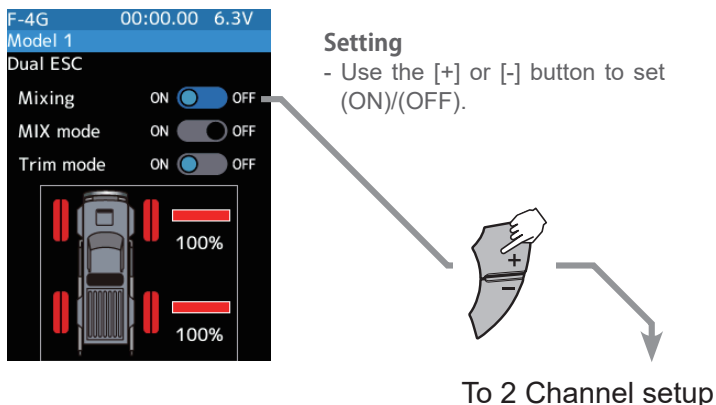

2 (Channel setup)

The channel list screen used for the front ESC channel is displayed. Press jog key the auxiliary channel that connected the front ESC channel.

- When all channels are in use, a screen saying "No assignable channel" is displayed, please turn off other mixing and make an unused channel. You can check the mixing used on the channel setting screen (Linkage menu).

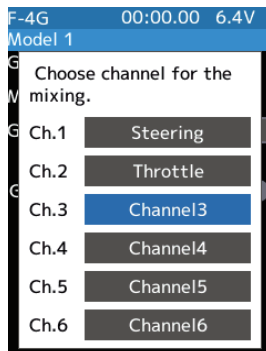

The number of channels varies depending on the selected system.

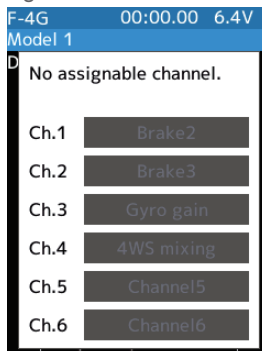

If there is no assignable channel, Select the [Close]. Turn off other mixing and make assignable channels.

3 (Drive ratio adjustment)

Select the track icon with the jog key to adjust the movement amount (ratio) of the front and rear motor controllers. The + button increases the rear ratio, and the - button decreases it. Either the front or rear is 100%.

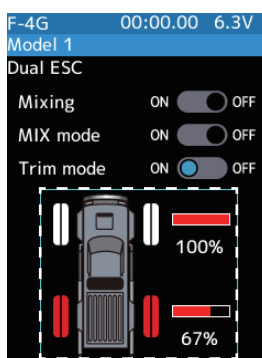

Adjustment buttons

+ button increases the rear ratio, and the - button decreases it. Return to the initial value by press the [+] and [-] button simultaneously

Rear rate (Rear mix rate)

0~100
Initial value: 100

4 (Mix mode setting)

Use the jog key to move the cursor to "MIX mode" ON/OFF. Use the [+] or [-] button to select ON/OFF.

"OFF": The EXP function of the 2nd CH and other settings are not mixed.

"ON": The EXP function of the 2nd CH and other settings are mixed.

Setting

- Use the [+] or [-] button to set (ON)/(OFF).

5 (Trim mode setup)

Use the jog key to move the cursor to "Trim mode" ON/OFF. Use the [+] or [-] button to select ON/OFF.

"OFF": The trim of the 2nd CH is not mixed.

"ON": The trim of the 2nd CH is mixed.

Setting

- Use the [+] or [-] button to set (ON)/(OFF).

6 When finished, return to the Mixing menu screen by pressing the END button, or press and hold the END button to return to the Home screen.

Trim/Dial Setting

The trim/dial select function can control the drive ratio with the digital dial or digital trim. (Linkage menu)

Note:

As this function drives two separate motor controllers simultaneously, a mutual load is applied. Use this function carefully so that the motor controllers are not damaged. Futaba will not be responsible for motor controller, motor, and other vehicle trouble due to the use of this function.

This function controls the Futaba CPS-1 channel power switch. Usually, when using the CPS-1 unit to light the vehicle dress-up and other illumination (LED) the CPS-1 unit with LED connected is connected to a vacant switch channel and the LEDs are turned on and off by switch while the vehicle is running. However, when the "CPS mixing" function is used, the LED can be turned on and off and flashed in step with steering and throttle operation. Well, as being turned on/off by the switch. The flashing speed (cycle) can be set. The LED can be flashed as a brake light by throttle brake side operation. Three lines of CPS mixing can be used.

The CPS-1 unit does not operate in UR/SR mode. Connect it to the channel of the normal mode.

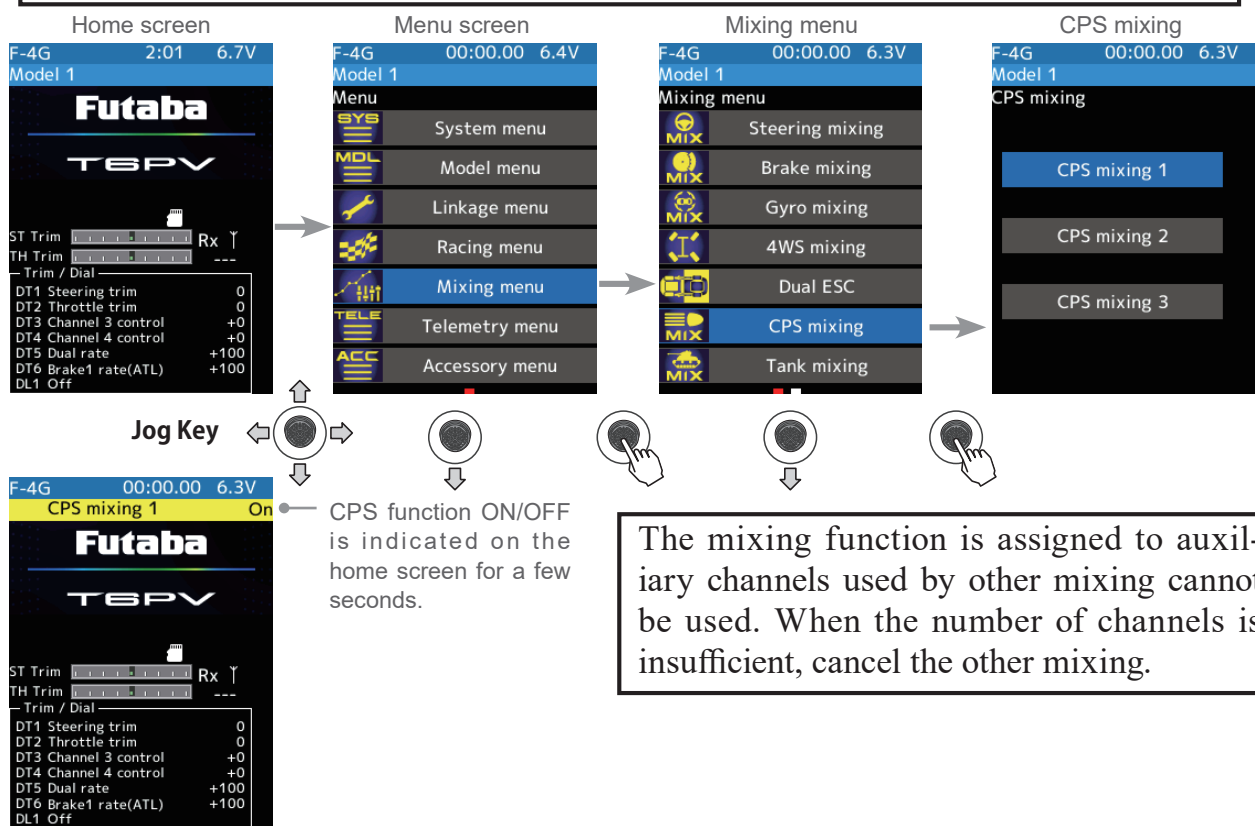

The mixing function is assigned to auxiliary channels used by other mixing cannot be used. When the number of channels is insufficient, cancel the other mixing.

CPS mixing adjustment

(Preparation)

- CPS-1 unit connects to the receiver's auxiliary channel.
- When the LEDs are turned on and off by a switch, use the function select switch function (Linkage menu) to set the switch to be used.
- From the CPS Mixing screen, Select the [CPS Mixing 1]/[CPS Mixing 2] or [CPS Mixing 3] to display the setting screen.

Setting

- Use the [+] or [-] button to set (ON)/(OFF).

1 (Function ON/OFF)

Use the jog key to move the cursor to "Mixing" ON/OFF. Use the [+] or [-] button to select ON/OFF.

"OFF": Mixing function OFF

"ON": Mixing function ON

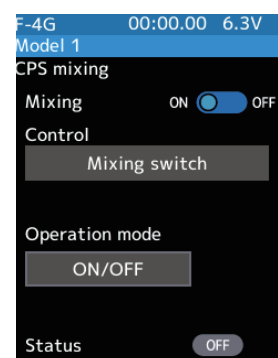

2 (Channel setup)

The channel list screen used for the CPS channel is displayed. Press jog key the auxiliary channel that connected the CPS-1 unit channel.

- When all channels are in use, a screen saying "No assignable channel" is displayed, please turn off other mixing and make an unused channel. You can check the mixing used on the channel setting screen (Linkage menu).

3 (Control system setup)

With the cursor on [Control], press the jog key. The mode list appears on the CPS mixing menu screen, and press jog key from the list and select the control mode.

- "Mixing Switch": ON/OFF by switch set at the CPS mixing
- "Steering neutral": ON at steering neutral
- "Steering endpoint": ON at both sides of steering
- "Throttle neutral": ON at throttle neutral
- "Throttle forward": ON at throttle forward side
- "Throttle brake": ON at throttle back (brake) side
- "Throttle neutral & brake": ON at throttle neutral and back (brake) sides

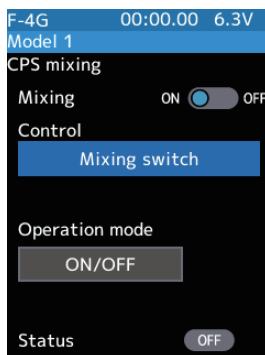

Setting

- Select with Jog key.
- Press jog key control mode.

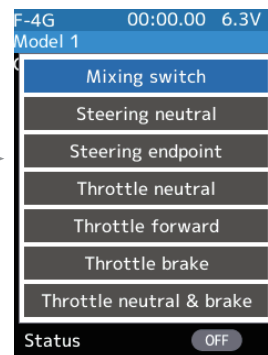

4 (ON/OFF switching position selection)

Select the value with jog key of the [ON/OFF point]. Use the [+] or [-] button to adjust the operation point. Since the ON/OFF state is displayed at the right side of the "Status", the setting can be confirmed while operating the function to be controlled (for example, throttle).

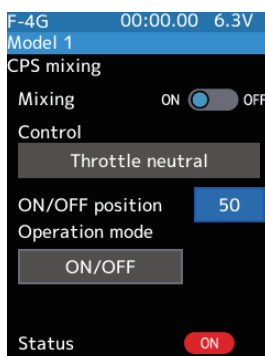

Adjustment buttons

- Adjust with the [+] or [-] button.
- Return to the initial value by press the [+] and [-] button simultaneously

ON/OFF position

5~95
Initial value: 50

5 (Operation mode setup)

Select [Operation mode]. The mode list appears on the CPS mixing menu screen, use the [+] or [-] button to select the operation mode.

- "ON/OFF": Normal ON/OFF type
- "Flash": Flashing display

Setting

- Press [+] or [-] button operation mode.

6 (Flashing cycle setting)

When "Operation mode" is set to "Flash", the "Cycle speed" can be set to the preferred setting. Select the value with jog key of the [Cycle speed]. Use the [+] or [-] button to adjust the cycle speed amount.

Adjustment buttons

- Adjust with the [+] or [-] button.
- Return to the initial value by press the [+] and [-] button simultaneously

Cycle speed amount

1~100
Initial value: 50

7 When finished, return to the Mixing menu screen screen by pressing the END button, or press and hold the END button to return to the Home screen.



Tank mixing

This function is intended for vehicles such as tanks and can be used for the pivotal turn, or the ultra-pivotal brake turn, by steering and throttle operation.

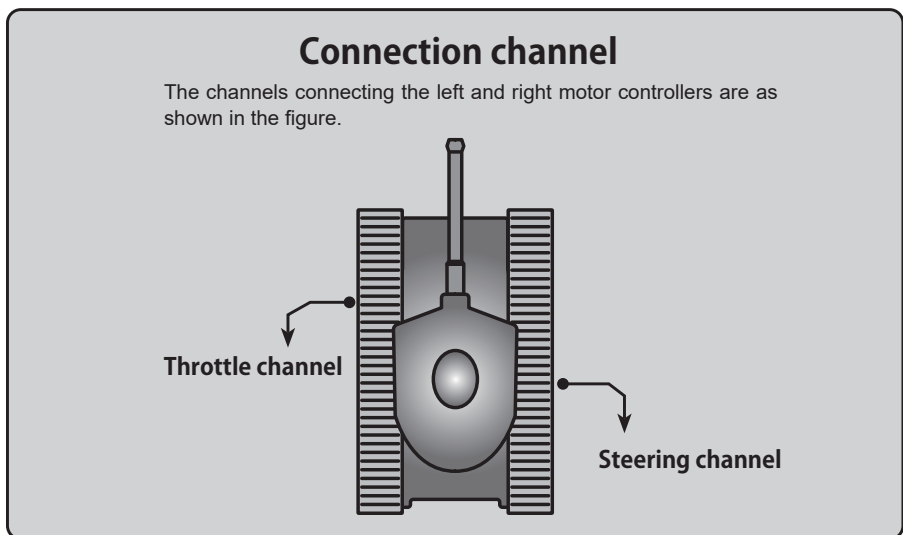
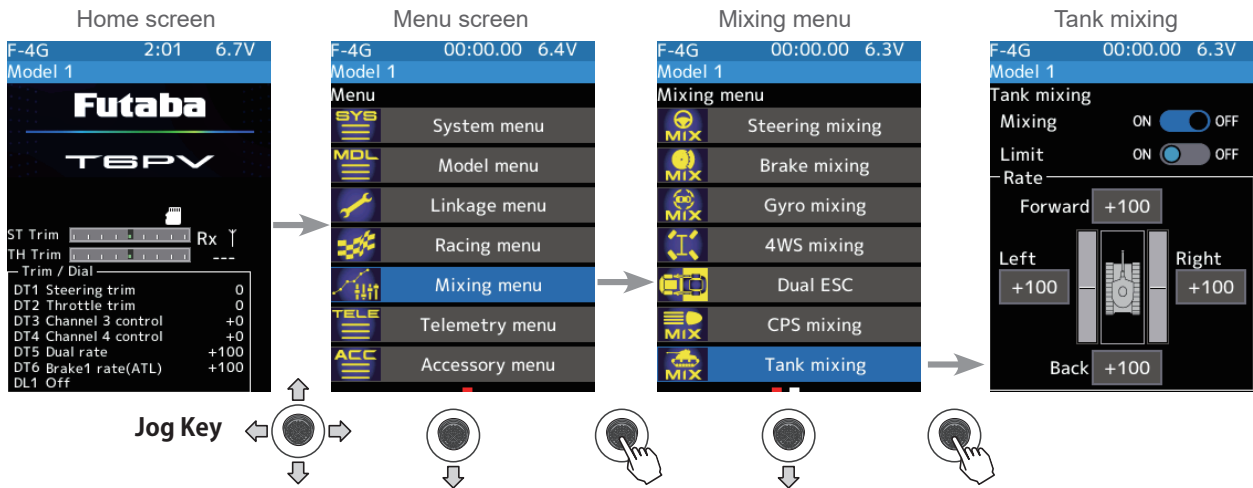

Tank mixing adjustment

- 1 (Function ON/OFF)
Use the jog key to move the cursor to "Mixing" ON/OFF. Use the [+] or [-] button to select ON/OFF.

"OFF": Mixing function OFF
"ON": Mixing function ON

Setting

- Use the [+] or [-] button to set (ON)/(OFF).

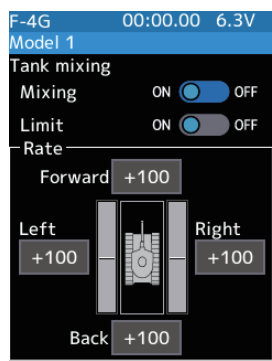

2 (Limit ON/OFF)

It is a function to limit the maximum operation amount of the steering and throttle channel so that it does not exceed the limit by the influence of the mixing amount.

Use the jog key to move the cursor to "Limit" ON/OFF. Use the [+] or [-] button to select ON/OFF.

"OFF": Limit function OFF

"ON": Limit function ON

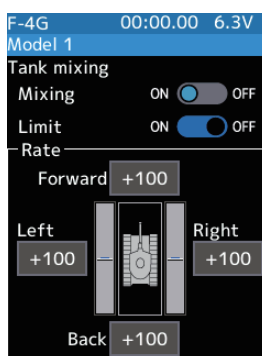

Setting

- Use the [+] or [-] button to set (ON)/(OFF).

3 (Forward/backward rate adjustment)

Select the value with jog key of the [Forward] or [Back]. Use the [+] or [-] button to adjust the forward or reverse speed.

- The throttle channel and the steering channel operate in conjunction with each other, and by operating the trigger to the high side, the car body advances at the [Forward] rate. When the trigger is operated to the brake side, it operates at the [Back] rate.

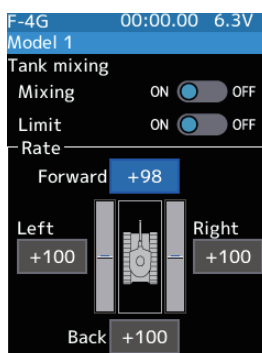

Adjustment buttons

- Adjust with the [+] or [-] button.
- Return to the initial value by press the [+] and [-] button simultaneously

Forward/backward rate

-100~+100

Initial value: +100

4 (Left/Right side travel adjust)

Select the value with jog key of the [Left] or [Right]. Use the [+] or [-] button to adjust the left or right side travel amount.

- When the throttle channel and the steering channel work in conjunction, when operating the steering wheel to the right, the car body turns to the right at the [Right] rate the pivotal turn. If you operate to the left, the car will turn to the left at the [Left] rate pivotal turn.

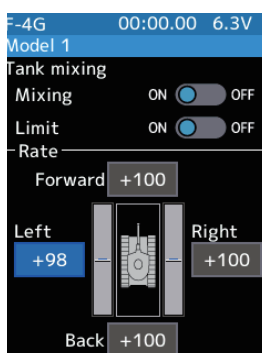

Adjustment buttons

- Adjust with the [+] or [-] button.
- Return to the initial value by press the [+] and [-] button simultaneously

Left/Right travel

-100~+100

Initial value: +100

- When finished, return to the Mixing menu screen by pressing the END button, or press and hold the END button to return to the Home screen.

When the steering, and trigger are operated at the same time.

If you manipulate the trigger to the high side and operate the steering wheel to the right, the tank will turn right at the rate of [Forward] with the jog key and press, [Right].

If you manipulate the trigger to the high side and operate the steering wheel to the left, the tank turns to the left at the rate of [Forward] with the jog key and press, [Left].

Operating the steering wheel while operating the trigger to the brake side will operate the same as the forward side in the reverse direction.



MIXING MENU

PMIX

Program mixing (1, 2, 3, 4, 5)

These functions allow you to apply mixing between the steering, throttle, and auxiliary channel.

Additional Functions

- When the steering or throttle channel is the master channel (the channel that applies mixing), trim data can be added. (Trim mode)
- The mixing mode selection. (Master mixing mode)
- The master channel mixing center point (the point at which the direction changes) can be offset. (Offset function)

Movement of the slave channel side

The movement of the master channel side will include movement of the slave channel side.

When the trigger ratio was set to 100:0

When the trigger ratio (Linkage menu→Throttle mode) is set to 100:0, brake operation stops. When the master channel is set to throttle, mixing operates only at the "Rate A (forward)" side. It does not operate at the "Rate B (brake)" side.

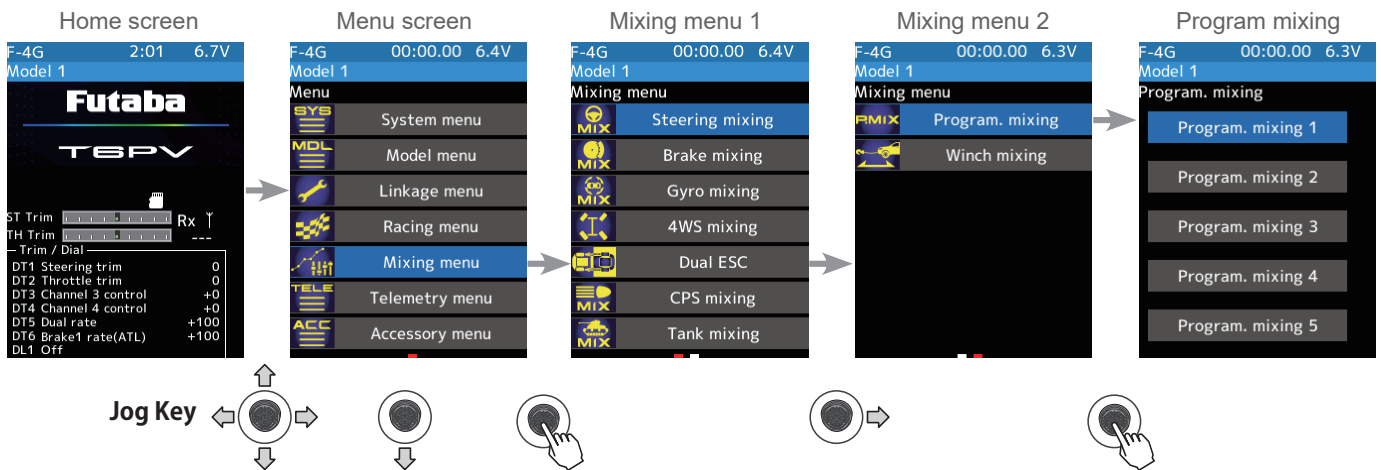

When the number of channels is insufficient, cancel the other mixing.

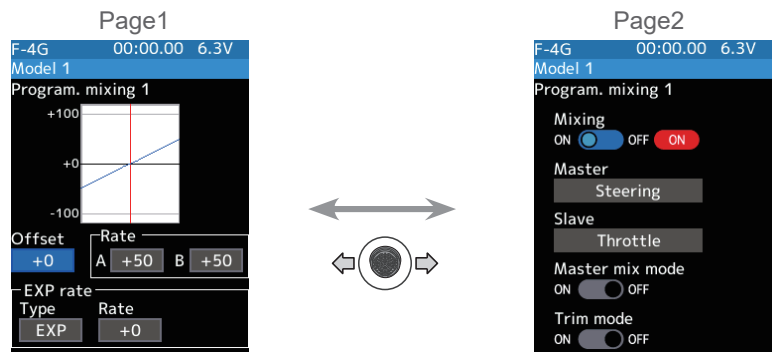

On page 1, the setting screen such as the curve, mixing rate adjustment screen, page 2, mixing ON/OFF, etc. is displayed.

Program composite adjustment

(Preparation)

- Use the switch select function (Linkage menu) to select the switch.
(as desired)
- From the Program mixing screen Select the [Program mixing 1-5] to use to move to the setting screen.



Setting

- Select 1-5 with the jog key.
- Press jog key.

1 (Function ON/OFF)

Operate the jog key left or right to display page 2.

Use the jog key to move the cursor to "Mixing" ON/OFF. Use the [+] or [-] button to select ON/OFF.

"OFF": Mixing function OFF

"ON": Mixing function ON

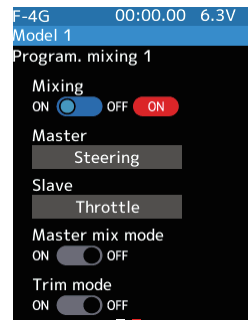

Setting

- Use the [+] or [-] button to set (ON)/ (OFF).

2 (Master/Slave channel setup)

Select [Master] or [Slave] with the jog key and press, and the channel setting screen will be displayed. Press jog key on that channel to select.

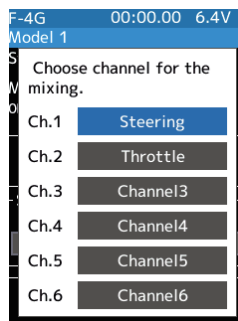
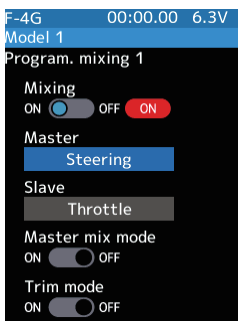

The number of channels varies depending on the selected system.

3 (Mix mode setting)

Use the jog key to move the cursor to "MIX mode" ON/OFF. Use the [+] or [-] button to select ON/OFF.

"OFF": The EXP function of the 2nd CH and other settings are not mixed.

"ON": The EXP function of the 2nd CH and other settings are mixed.

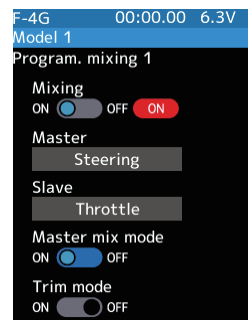

4 (Trim mode setup)

Use the jog key to move the cursor to "Trim mode" ON/OFF. Use the [+] or [-] button to select ON/OFF.

"OFF": The trim of the 2nd CH is not mixed.

"ON": The trim of the 2nd CH is mixed.

Setting

- Use the [+] or [-] button to set (ON)/ (OFF).

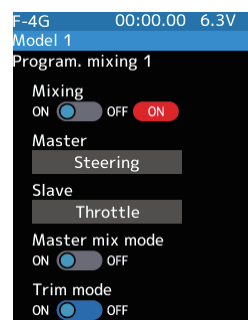

5 (Left, Forward or A side mixing amount adjustment)

Operate the jog key left or right to display page 1. Select the value with jog key of the "Rate A". Use the [+] or [-] button to adjust the "A" side travel amount.

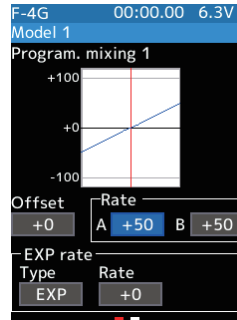

Adjustment buttons

- Adjust with the [+] or [-] button.
- Return to the initial value by press the [+] and [-] button simultaneously

Left/Forward/A side rate

-120~0~+120
Initial value: +50

6 (Right, brake or B side mixing amount adjustment)

Select the value with jog key of the "Rate B". Use the [+] or [-] button to adjust the "B" side travel amount.

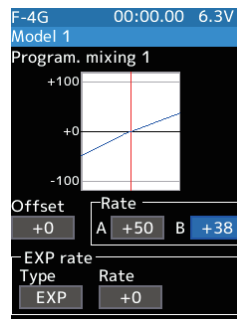

Adjustment buttons

- Adjust with the [+] or [-] button.
- Return to the initial value by press the [+] and [-] button simultaneously

Right/Brake/B side rate

-120~0~+120
Initial value: +50

7 (Curve setting)

"EXP/VTR" mixing can be set from master channel to slave channel.

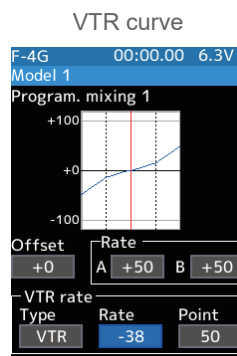
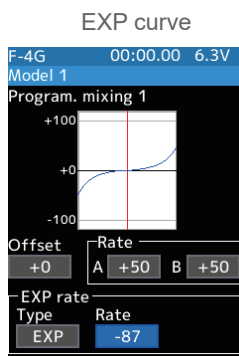

EXP adjustment

(Preparation)

-Use the jog key to move the cursor to "Type" and use the [+] or [-] button to select "EXP".

- 1 Select the value with jog key of the [EXP rate]. Use the [+] or [-] button to set the rate. When you want to quicken steering operation, use the [+] button to adjust the + side. When you want to make steering operation milder, use the [-] button to adjust the - side.

Adjustment buttons

- Adjust with the [+] or [-] button.
- Return to the initial value by press the [+] and [-] button simultaneously

Curve rate

-100~+100

Initial value: +0

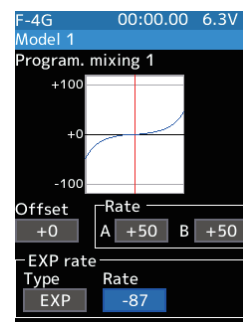
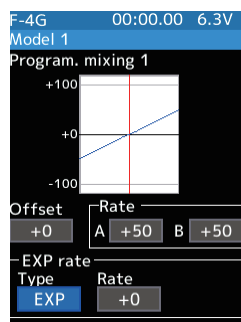

- 2 When finished, return to the Mixing menu screen screen by pressing the END button, or press and hold the END button to return to the Home screen.

VTR adjustment

(Preparation)

-Use the jog key to move the cursor to "Type" and use the [+] or [-] button to select "VTR".

- 1 Select the value with jog key of the [VTR rate]. Use the [+] or [-] button to set the rate. When you want to quicken steering operation, use the [+] button to adjust the + side. When you want to make steering operation milder, use the [-] button to adjust the - side.

Adjustment buttons

- Adjust with the [+] or [-] button.
- Return to the initial value by press the [+] and [-] button simultaneously

Curve rate

-100~+100

Initial value: +0

Point

1~99

Initial value: 50

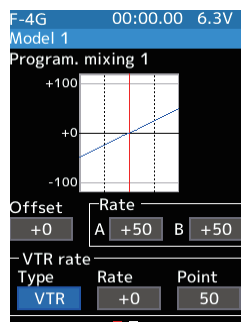

- 2 Curve switching point adjustment
Select the value with jog key of the [Point]. use the [+] or [-] button to move to the point you want to set.

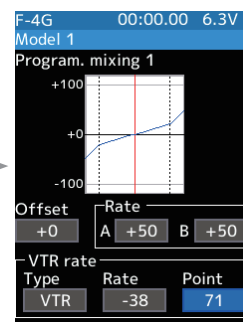
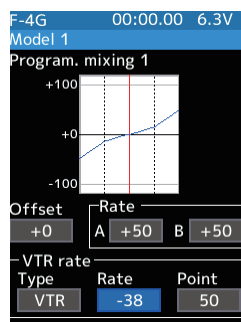

- 3 When finished, return to the Mixing menu screen screen by pressing the END button, or press and hold the END button to return to the Home screen.



Winch mixing

This mixing function allows any Trim/Dial to control a winch. The Trim/Dial will only move the device forward or reverse when the button is activated or pressed acting in a momentary manner. Movement will stop when the switch is released.

Winch mixing uses a winch and applies bidirectional mixing from the throttle to winch and from the winch to throttle so that the rock crawler and winch can operate simultaneously with one input.

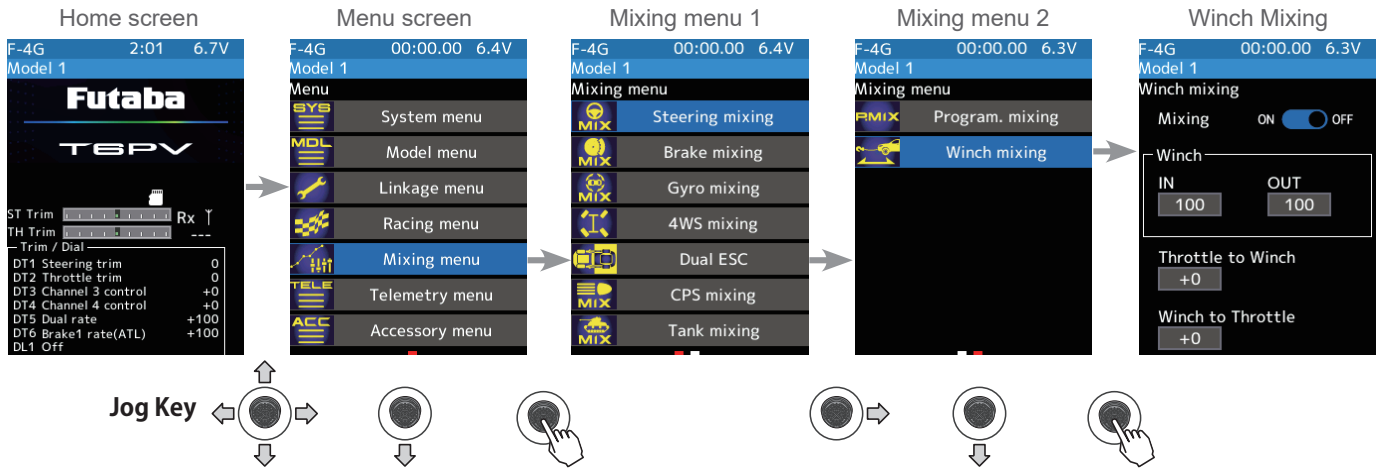

Winch mixing adjustment

(Preparation)

Use the "Trim/Dial select" function to select the winch channel operation dial (Linkage menu)

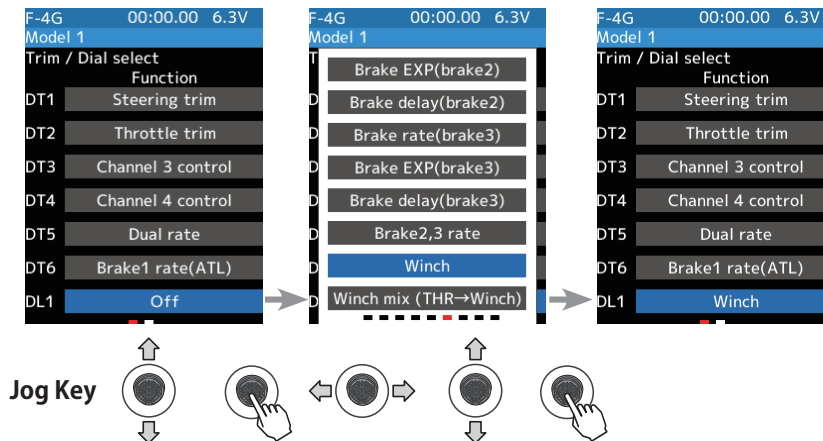

1 (Function ON/OFF)

Use the jog key to move the cursor to mixing ON/OFF. Use the [+] or [-] button to select ON/OFF.

"OFF": Mixing function OFF
 "ON": Mixing function ON

Setting

- Use the [+] or [-] button to set (ON)/(OFF).

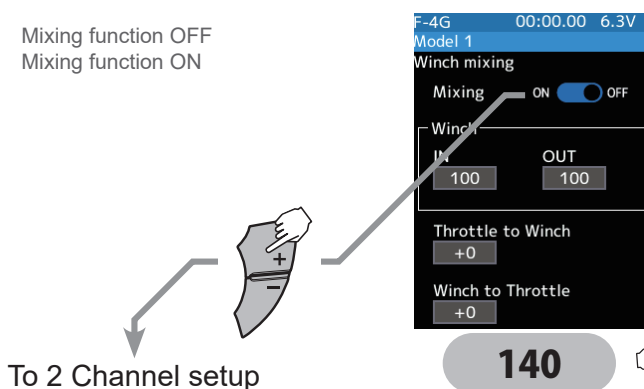

2 (Channel setup)

The channel list screen used for the winch is displayed. Press jog key the auxiliary channel that connect the winch.

- When all channels are in use, a screen saying "No assignable channel" is displayed, please turn off other mixing and make an un-used channel. You can check the mixing used on the channel setting screen (Linkage menu).

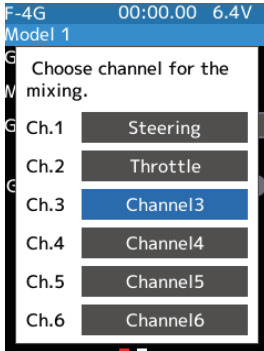

The number of channels varies depending on the selected system.

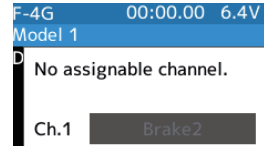

If there is no assignable channel, Select the [Close]. Turn off other mixing and make assignable channels.

3 (-Set the amount of movement)

Select the value with jog key on the [IN] or [OUT]. Use the [+] or [-] button to adjust each movement amount.



Adjustment buttons

- Adjust with the [+] or [-] button.
- Return to the initial value by press the [+] and [-] button simultaneously

IN/OUT amount
0~100
Initial value: 100

Mixing from the winch to throttle and throttle to winch can be set.

4 (-Throttle to Winch adjustment)

Select the value with jog key on the [Throttle to Winch]. Use the [+] or [-] button to adjust the mixing amount.

- The mixing operation from the throttle to the winch does not exceed the range of winch operation set with [IN]/[OUT].



Adjustment buttons

- Adjust with the [+] or [-] button.
- Return to the initial value by press the [+] and [-] button simultaneously

Throttle to Winch amount
-100~+100
Initial value: +0

5 (-Winch to Throttle adjustment)

Select the value with jog key on the [Winch to Throttle] with the jog key and press, Use the [+] or [-] button to set the rate. Use the buttons to adjust the mixing amount.



Adjustment buttons

- Adjust with the [+] or [-] button.
- Return to the initial value by press the [+] and [-] button simultaneously

Winch to Throttle amount
-100~+100
Initial value: +0

Trim/Dial Setting

The mixing rate amount can be controlled with the digital dial or digital trim, using the trim/dial select function. (Linkage menu)

Telemetry system

With the telemetry system, the running status can be displayed at the transmitter and also recorded as a data log by installing various sensor units to the chassis

(The S-FHSS systems do not have a telemetry function.)

-The sensor data can be checked at the transmitter by connecting the telemetry sensor sold separately to the S.BUS2 (S) port of the R404SBS receiver.

-To record telemetry information in the log, set the start/stop switch using the "Switch Selection" function (Linkage menu).

The log data recorded on a microSD card can be converted to CSV format by the telemetry log converter released on our web page. When copying or moving the log file, always select both .FLI and .FLD files.

-The connection diagram below is an example of the telemetry sensors. The data of up to the following various types of sensors and the receiver power supply voltage can be transmitted by using the 3-way extension cord or double extension cord sold separately.

The receiver power supply can also be connected to the S.BUS2 connector or channel 1 to 4 connector. No sensor is required to measure the receiver supply voltage.

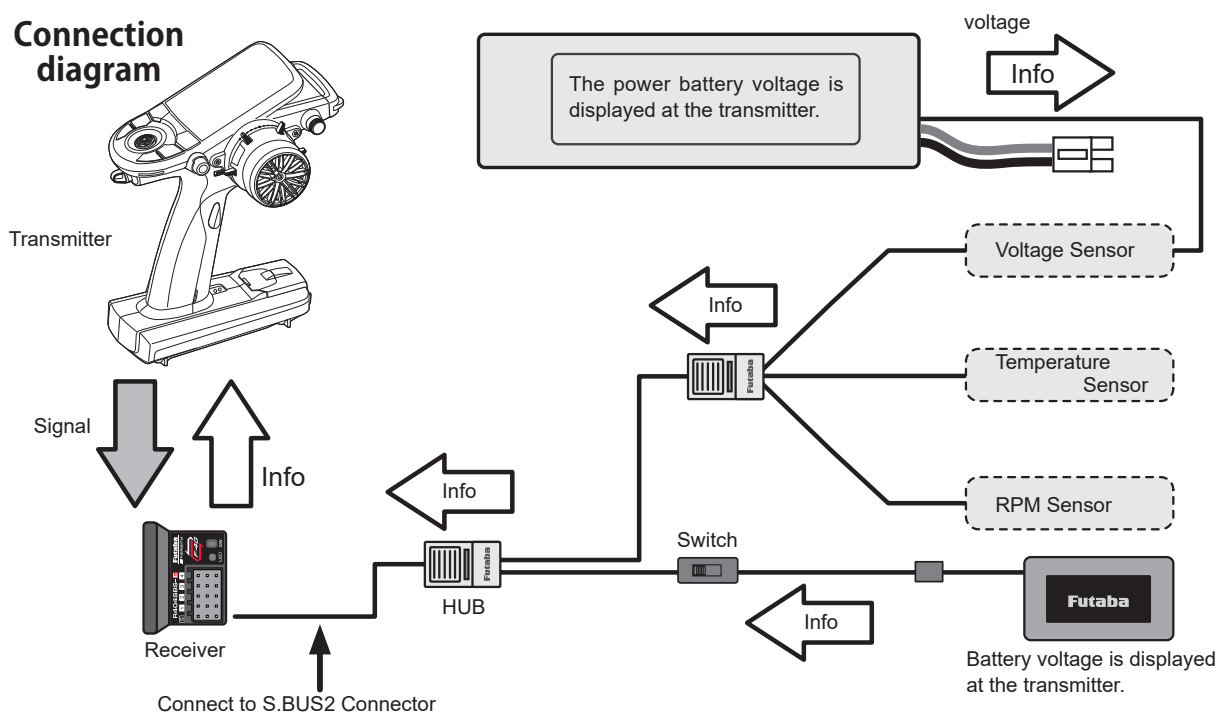

*Info: Info displayed at the transmitter

Usable sensor options (As of January 2025)

Temperature sensor (SBS-01T) Perfect for engine head, etc.

Temperature sensor (SBS-01TE) Used by attaching to a motor, etc.

RPM Sensor (SBS-01RM) Measures speed over the 360 to 100,000 rpm range.

Brushless type RPM Sensor (SBS-01RB) Measures speed over the 360 to 300,000 rpm range.

Voltage Sensor (SBS-01V) Measures external power supply voltages up to 100 V.

Current sensor (SBS-01C) Measures external power supply voltages up to 70 V, capacity and consumption capacity.

T Telemetry

This screen displays and sets the various information from the receiver. The telemetry can be used in the F-4G and T-FHSS system. An alarm can be generated depending on the information. Each information screen sets the alarm. For example, a drop in the voltage of the receiver battery housed in the model car can be reported by an alarm. The telemetry data received last is memorized. Therefore, even if the receiver power is turned off, information display, and alarms remain until the transmitter power is turned off. The speech function can be turned on and off with the specified switch. See the “Switch select” function (Linkage menu).

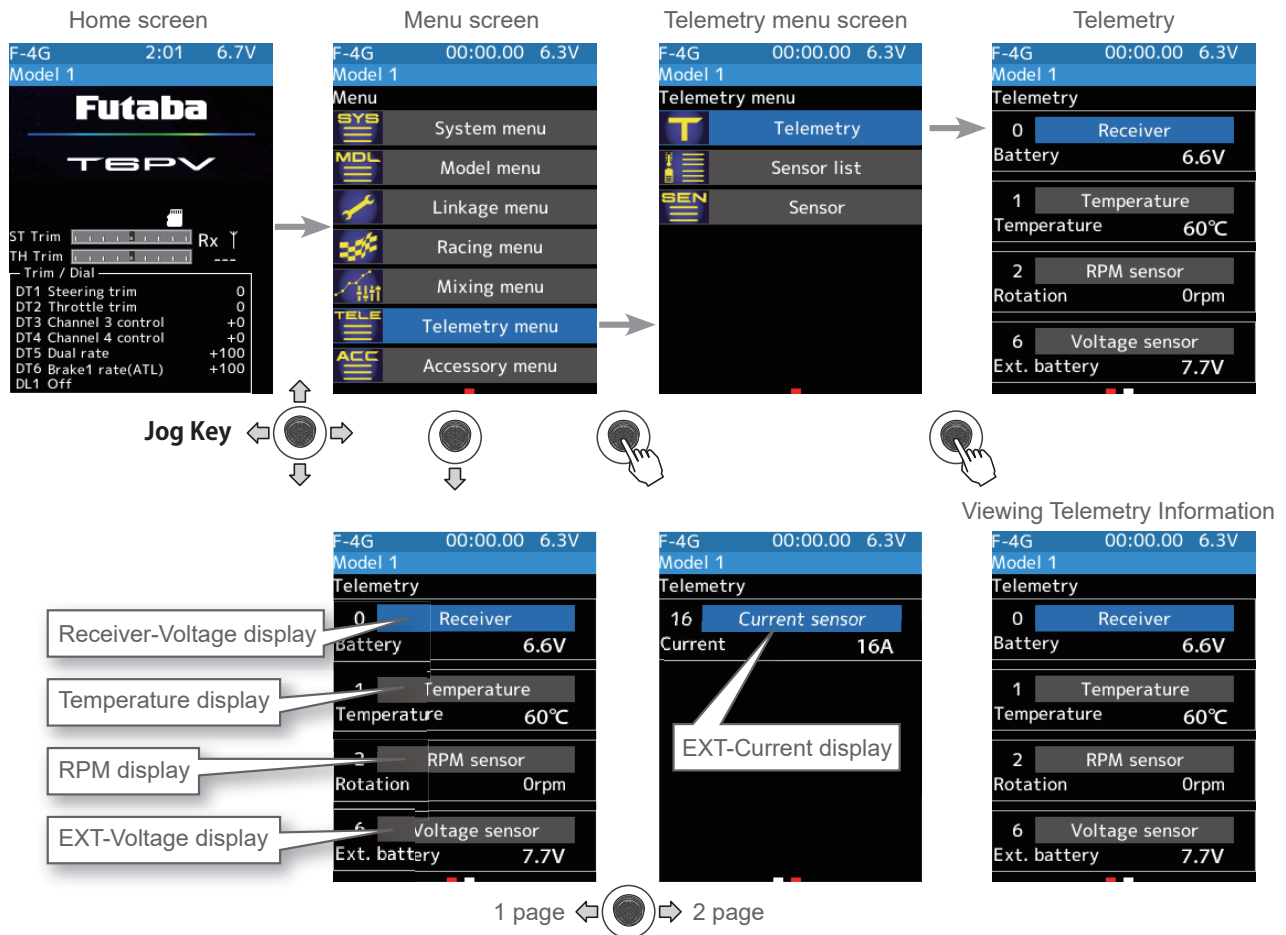

Using Telemetry function

(Preparation)

The sensor used is connected with the receiver refers to the connection diagram of previous page.

1 (Function ON/OFF)

Call up the [Linkage menu] → [Receiver] screen.

Use the jog key to move the cursor to telemetry ON/OFF.

Use the [+] or [-] button to select ON/OFF.

"OFF": Telemetry function OFF

"ON": Telemetry function ON

[Linkage menu] → [Receiver]

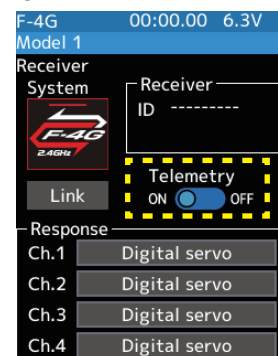

Telemetry function ON

Telemetry: Receiver Battery Voltage

This function displays and sets the receiver power supply battery. The sensor sold separately does not have to be installed. The transmitter's initial status voltage is also displayed. For a description of the alarm set when the voltage drops, see the description of the procedure on this page.

The diagram illustrates the navigation from the main Telemetry menu to the Receiver Battery Voltage settings screen. The left screen shows the Telemetry menu with options for Receiver, Temperature, RPM sensor, and Voltage sensor. The right screen shows the Receiver Battery Voltage settings, including the current voltage (6.1V), min/max values (6.1V/6.1V), alarm settings (Inhibit), and limit voltage (4.0V). Callouts provide detailed explanations for each element.

- Current receiver battery voltage:** 6.1V
- The minimum and maximum when powering ON are shown:** 6.1V/ 6.1V
- *Select and press this with the jog key to reset and restart measurement from that point.** (Referring to the Inhibit button)
- Alarm ON/OFF setting (The ↓ arrow indicates that an alarm is generated when the power supply voltage drops below the set value.)** (Referring to the Alarm setting)
- Sets the limiter voltage (Voltage that sounds an alarm)** (Referring to the Limit setting)

Alarm function setup

1 (Alarm function setup)

Use the jog key to place the cursor on the [Alarm], and use the [+] or [-] button to select [Buzzer] or [Inhibit].

"Inhibit": No audible alarm

"Buzzer": Audible alarm

Setting

- Select with the [+] or [-] button.
Inhibit/Buzzer

2 (Limit adjustment)

Use the jog key to place the cursor on the [Limit], and use the [+] or [-] button to adjust the limit voltage.

Setting

- Adjust with the [+] or [-] button.
Limit voltage

3 When finished, return to the Telemetry screen screen by pressing the END button, or press and hold the END button to return to the Home screen.

Telemetry: The Drive Battery Voltage

This function displays and sets the voltage of an external power supply (drive battery, etc.) separately installed in the chassis. Receiver S.BUS 2 connector is used to connect SBS-01V sensor and battery.

* A drive battery sensor must be installed in the model car. Install and connect the sensor following the sensor instruction manual.

The diagram illustrates the navigation from the main Telemetry menu to the Voltage sensor settings screen. The main menu shows various sensors: Receiver (6.6V), Temperature (60°C), RPM sensor (6600rpm), and Voltage sensor (7.7V). The Voltage sensor screen shows the current receiver battery voltage (6.6V), minimum and maximum values (6.6V / 7.6V), an Alarm setting (Inhibit), a Limit setting (10.0V), and Total capacity (0mAh). Callouts provide detailed explanations for these values and settings.

- Current receiver battery voltage:** 6.6V
- The minimum and maximum when powering ON are shown:** 6.6V / 7.6V
- *Select and press this with the jog key to reset and restart measurement from that point.** (Referring to the Alarm setting)
- Alarm ON/OFF setting (The ↓ arrow indicates that an alarm is generated when the power supply voltage drops below the set value.)** (Referring to the Alarm setting)
- Sets the limiter voltage (Voltage that sounds an alarm)** (Referring to the Limit setting)

Alarm function setup

1 (Alarm function setup)

Use the jog key to place the cursor on the [Alarm], and use the [+] or [-] button to select [Buzzer] or [Inhibit].

"Inhibit": No audible alarm

"Buzzer": Audible alarm

Setting

- Select with the [+] or [-] button.
Inhibit/Buzzer

2 (Limit adjustment)

Use the jog key to place the cursor on the [Limit], and use the [+] or [-] button to adjust the limit voltage.

Setting

- Adjust with the [+] or [-] button.
Limit voltage

3 When finished, return to the Telemetry screen screen by pressing the END button, or press and hold the END button to return to the Home screen.

Telemetry: RPM

Speed information from an SBS-01RM (telemetry rotation sensor) sold separately is displayed and set at this screen. The speed of the engine, motor, etc. of the chassis while running can be viewed at the transmitter. When the speed becomes higher (lower) than the set speed, it can be announced by an alarm.

* A RPM sensor must be installed in the model car. Install and connect the sensor following the sensor instruction manual.

The diagram illustrates the navigation from the main Telemetry menu to the RPM sensor configuration screen. The left screen shows a list of sensors: Receiver (6.6V), Temperature (60°C), RPM sensor (6600rpm), and Voltage sensor (7.7V). The right screen shows the RPM sensor configuration with fields for Current RPM (0rpm), Alarm (Inhibit), Limit (2000rpm), and Ratio (1.00). Callouts explain the fields: Current RPM, Alarm ON/OFF setting (up arrow indicates alarm generated), Limit (sets limiter RPM), and Ratio (gear ratio).

Alarm function setup

1 (Alarm function setup)

Use the jog key to select [Alarm]. Use the [+] or [-] button to "Inhibit" or "Buzzer".

"Inhibit": No audible alarm "Buzzer": Audible alarm

2 (Limit adjustment)

Use the jog key to select [Limit]. Use the [+] or [-] button to set the limit rate.

Adjustment buttons

- Adjust with the [+] or [-] button.
- Return to the initial value by press the [+] and [-] button simultaneously

3 (Gear ratio adjustment)

Use the jog key to select [Gear ratio]. Use the [+] or [-] button to set the rate.

4 When finished, return to the Telemetry screen screen by pressing the END button, or press and hold the END button to return to the Home screen.

Telemetry: Temperature

This screen displays and sets the temperature information from an SBS-01T (telemetry temperature sensor) sold separately. The temperature of the engine, motor, amp, etc. of the chassis while running can be viewed at the transmitter. When the temperature becomes higher or lower than the set value, it can be announced by an alarm.

* A temperature sensor must be installed in the model car. Install and connect the sensor following the sensor instruction manual.

Telemetry

F-4G	00:00.00	6.3V
Model 1		
Telemetry		
0	Receiver	
Battery		6.6V
1	Temperature	
Temperature		60°C
2	RPM sensor	
Rotation		6600rpm
6	Voltage sensor	
Ext. battery		7.7V

Temperature

F-4G	00:00.00	6.3V
Model 1		
Temperature		
		66°C
min./max.		24/ 66°C
↑		
Alarm		Inhibit
Limit		100°C
↓		
Alarm		Inhibit
Limit		0°C

Callouts:

- Current temperature
- The minimum and maximum when powering ON are shown. *Select and press this with the jog key to reset and restart measurement from that point.
- Alarm ON/OFF setting (↑ Arrow indicates that an alarm is generated when the number exceeds the set value.)
- Alarm ON/OFF setting (↓ Arrow indicates that an alarm is generated when the number drops below the set value.)
- Limit temperature setting (Temperature that sounds an alarm)

Alarm function setup

1 (Alarm function setup)

Use the jog key to select [Alarm]. Use the [+] or [-] button to "Inhibit" or "Buzzer".

"Inhibit": No audible alarm "Buzzer": Audible alarm

2 (Limit adjustment)

Use the jog key to select [Limit]. Use the [+] or [-] button to set the limit rate.

Adjustment buttons

- Adjust with the [+] or [-] button.
- Return to the initial value by press the [+] and [-] button simultaneously

3

When finished, return to the Telemetry screen screen by pressing the END button, or press and hold the END button to return to the Home screen.

Telemetry: The Drive Battery Electric Current

When the SBS-01C (electric current sensor) sold separately is mounted on the vehicle, the electric current, voltage, and consumption capacity of the power battery, etc., can be displayed.

* A drive battery electric current sensor must be installed in the model car. Install and connect the sensor following the sensor instruction manual.

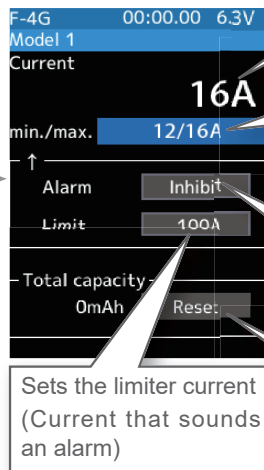
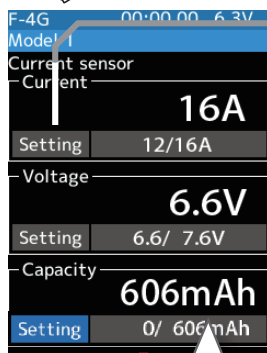
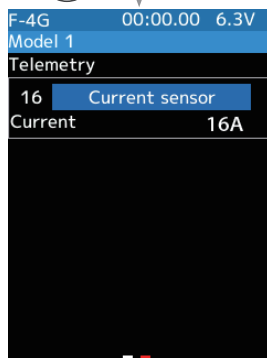
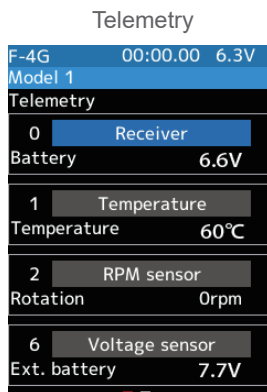

Current drive battery electric current

The minimum and maximum when powering ON are shown.
*Select and press this with the jog key to reset and restart measurement from that point.

Alarm ON/OFF setting (↑ Arrow indicates that an alarm is generated when the number exceeds the set value.)

Reset total capacity

Sets the limiter current (Current that sounds an alarm)

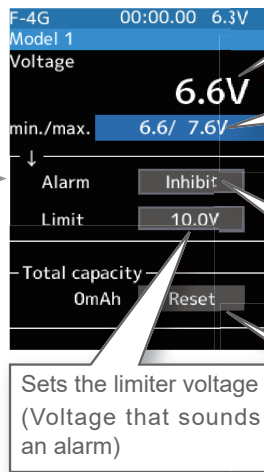

Current drive battery voltage

The minimum and maximum when powering ON are shown.
*Select and press this with the jog key to reset and restart measurement from that point.

Alarm ON/OFF setting (↓ Arrow indicates that an alarm is generated when the number drops below the set value.)

Reset total capacity

Sets the limiter voltage (Voltage that sounds an alarm)

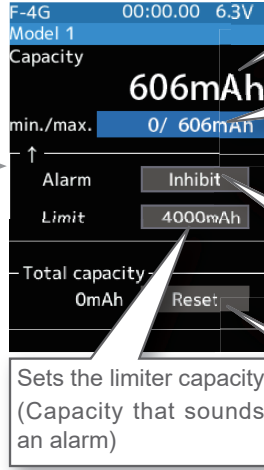

Current drive battery capacity

The minimum and maximum when powering ON are shown.
*Select and press this with the jog key to reset and restart measurement from that point.

Alarm ON/OFF setting (↑ Arrow indicates that an alarm is generated when the number exceeds the set value.)

Reset total capacity

Sets the limiter capacity (Capacity that sounds an alarm)

-Upper side:
Current current/voltage/consumption capacity display.

-Lower:
This is a display of the minimum value/maximum value of the measured current/voltage/consumption capacity after turning on the transmitter power.

* Press jog key the min/max display button to restart the measurement.

Alarm function setup

1 (Alarm function setup)

Use the jog key to select [Alarm]. Use the [+] or [-] button to "Inhibit" or "Buzzer".

"Inhibit": No audible alarm "Buzzer": Audible alarm

2 (Limit adjustment)

Use the jog key to select [Limit]. Use the [+] or [-] button to set the limit rate.

Adjustment buttons

- Adjust with the [+] or [-] button.
- Return to the initial value by press the [+] and [-] button simultaneously

3 When finished, return to the Telemetry screen screen by pressing the END button, or press and hold the END button to return to the Home screen.

Reset total capacity display

Unless the reset button of SBS-01C is pressed, the consumption capacity measured by SBS-01C is maintained and displayed as "integrated capacity" on the screen. If you wish to measure the consumption capacity for one run, it is possible to reset the consumption capacity display on the transmitter by the next operation. However, the record of the integrated capacity of the SBS-01C main body cannot be reset by the function which resets the transmitter display.

1 (Reset operation)

Select [Reset] with the jog key and press it. Next, press the jog key while the cursor is on "Yes" on the confirmation screen. The consumption capacity display is reset to "0". The consumption capacity from the time of reset is displayed until you reset it again. If you reset the consumption capacity by pressing the reset button of SBS-01C, the consumption capacity display on the transmitter is also reset.

2 When finished, return to the Telemetry screen screen by pressing the END button, or press and hold the END button to return to the Home screen.

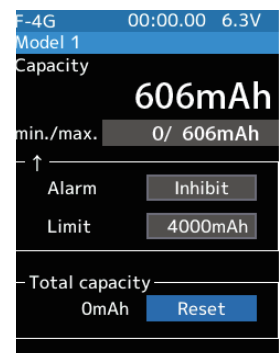

The reset operation on the transmitter resets the integrated capacity display on the T6PV. It does not reset the integrated capacity on the SBS-01C. The consumption capacity measurement range of SBS-01C is 32767 mAh maximum. When this value is exceeded, the consumption capacity display on the transmitter is also reset automatically. Depending on the timing, reset may occur during measurement. Therefore, make sure to reset the integrated capacity on the SBS-01C before the integrated capacity display reaches 32767 mAh.

Telemetry: MC/Acuvance

It is possible to display the following information for MC971CR/Acuvance compatible ESCs:

- Rotation speed ●ESC internal temperature ●Motor temperature* ●Battery voltage.

*The motors that support the motor temperature measurement function are the "LUXON AGILE" series manufactured by Acuvance Co., Ltd. Motor temperature measurement is not guaranteed if any other motor is connected.

- To display using telemetry, set the MC971CR to [MC Link Mode]. It cannot be displayed in [ESC Mode].

ESC Temp. Setting

- Current temperature
- The minimum and maximum when powering ON are shown.
- *Select and press this with the jog key to reset and restart measurement from that point.
- Alarm ON/OFF setting (↑ Arrow indicates that an alarm is generated when the number exceeds the set value.)
- Alarm ON/OFF setting (↓ Arrow indicates that an alarm is generated when the number drops below the set value.)
- Limit temperature setting (Temperature that sounds an alarm)

Rotation Setting

- Current RPM
- The maximum when powering ON are shown.
- *Select and press this with the jog key to reset and restart measurement from that point.
- Alarm ON/OFF setting (↑ Arrow indicates that an alarm is generated when the number exceeds the set value.)
- Alarm ON/OFF setting (↓ Arrow indicates that an alarm is generated when the number drops below the set value.)
- Sets the limiter RPM (RPM that sounds an alarm)

Motor Temp. Setting

- Current temperature
- The minimum and maximum when powering ON are shown.
- *Select and press this with the jog key to reset and restart measurement from that point.
- Alarm ON/OFF setting (↑ Arrow indicates that an alarm is generated when the number exceeds the set value.)
- Alarm ON/OFF setting (↓ Arrow indicates that an alarm is generated when the number drops below the set value.)
- Limit temperature setting (Temperature that sounds an alarm)

Current drive battery voltage

The minimum and maximum when powering ON are shown.
*Select and press this with the jog key to reset and restart measurement from that point.

Alarm ON/OFF setting (↑ Arrow indicates that an alarm is generated when the number exceeds the set value.)

Alarm ON/OFF setting (↓ Arrow indicates that an alarm is generated when the number drops below the set value.)

Sets the limiter voltage (Voltage that sounds an alarm)

-Upper side:
Current current/voltage/consumption capacity display.

-Lower:
This is a display of the minimum value/maximum value of the measured current/voltage/consumption capacity after turning on the transmitter power.
* Press jog key the min/max display button to restart the measurement.

Alarm function setup

1 (Alarm function setup)

Use the jog key to select [Alarm]. Use the [+] or [-] button to "Inhibit" or "Buzzer".

"Inhibit": No audible alarm "Buzzer": Audible alarm

2 (Limit adjustment)

Use the jog key to select [Limit]. Use the [+] or [-] button to set the limit rate.

Adjustment buttons

- Adjust with the [+] or [-] button.
- Return to the initial value by press the [+] and [-] button simultaneously

3 When finished, return to the Telemetry screen screen by pressing the END button, or press and hold the END button to return to the Home screen.



Sensor list

This menu registers the telemetry sensors used with the transmitter. When only one of a certain type of sensor is used, this setting is unnecessary, and the sensor can be used by directly connecting it to the S.BUS2 port of the transmitter.

When using two or more of the same kind of sensors, they must be registered here.

What is a slot?

Servos classified by "CH", but sensors are classified in units called "slots". There are slots from No. 1 to No. 31. Using a sensor that uses two or more slots, the required number of slots is automatically assigned by setting up a start slot. When two or more of the same kind of sensor are used, the sensors themselves must allocate unused slots and memorize that slot.

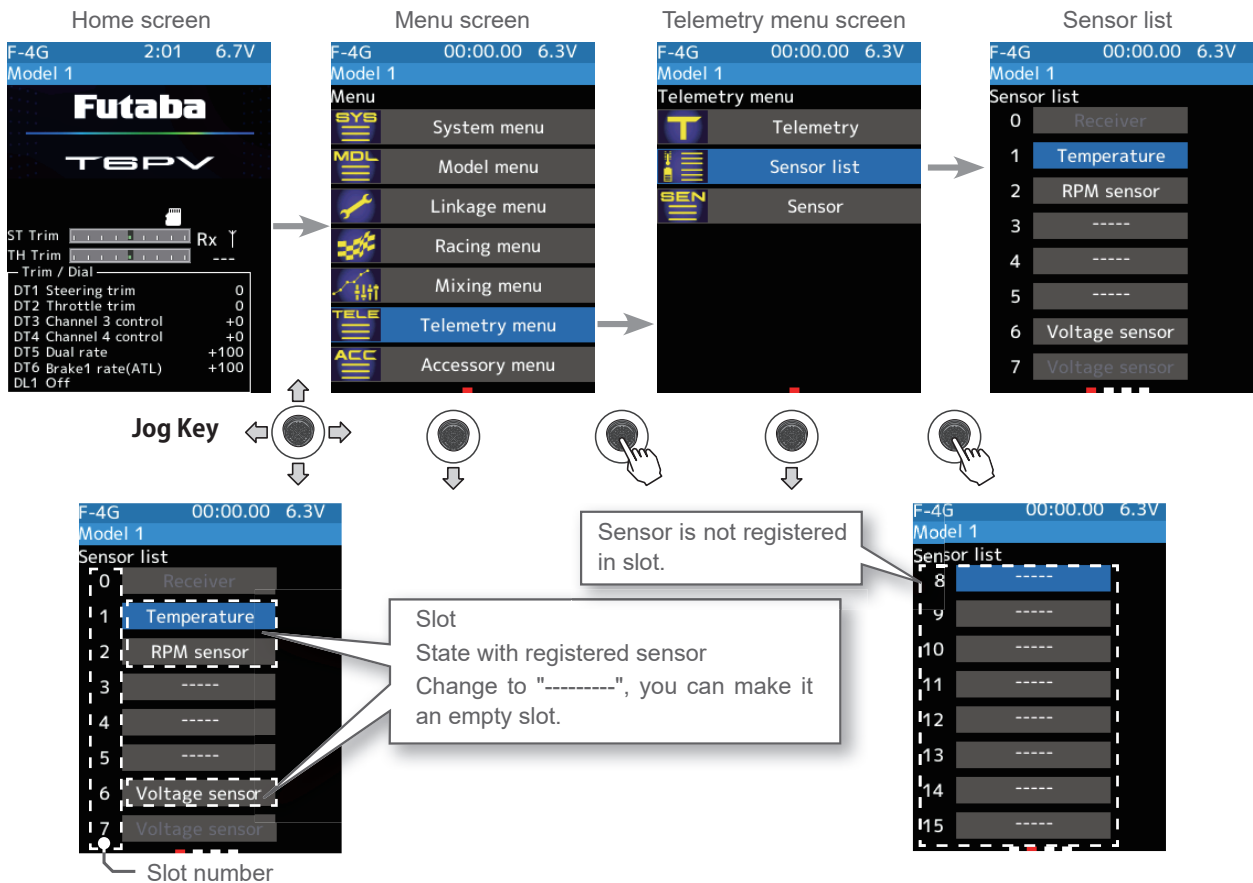

About the slots that can be used.

- As shown in the table below, the current sensor requires three consecutive slots, and the MC/Acuance requires 7 consecutive slots. The MC/Acuance has a starting slot of 1, 8, 9, 16, 17, 24, 25.

sensor	The required number of slots	The number which can be used as a start slot
TEMP (SBS-01T)	1 slot	1~31
RPM (SBS01RM)	1 slot	1~31
Voltage (SBS-01V)	2 slot	1, 2, 3, 4, 5, 6, 8, 9, 10, 11, 12, 13, 14, 16, 17, 18, 19, 20, 21, 22, 24, 25, 26, 27, 28, 29, 30
Current (SBS-01C)	2 slot	1, 2, 3, 4, 5, 8, 9, 10, 11, 12, 13, 16, 17, 18, 19, 20, 21, 24, 25, 26, 27, 28, 29
MC/Acuance	7 slot	1, 8, 9, 16, 17, 24, 25

How to change start slot and set empty slot

1 (Start slot selection)

Select the [Slot] with the jog key and press, the list of sensors that can be registered in the start slot, will be displayed. Sensors that cannot be changed are not displayed.

Start slot selection

- Select with jog key and press

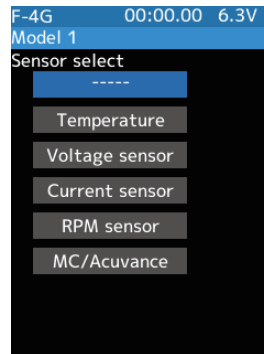

2 (Sensor selection)

From the sensor list, press jog key the sensor you want to register in the start slot. To set as an empty slot, Select the [-----]. This completes the change.

Sensor selection

- Select with jog key and press

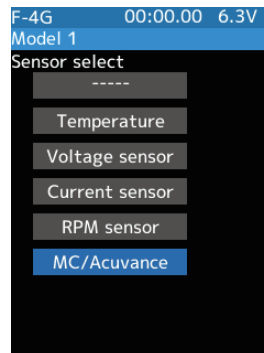

3

When finished, return to the Sensor list screen screen by pressing the END button, or press and hold the END button to return to the Home screen.

With this menu, you can display the telemetry meter on the home screen.

Also, you can register a telemetry sensor in the transmitter. When using each sensor of the initial setting one by one, setting here is unnecessary. You can use it by connecting the purchased sensor to the S.BUS 2 port of the receiver. If you use multiple sensors of the same type, such as temperature sensor for both battery and motor, you need to register that sensor in the transmitter.

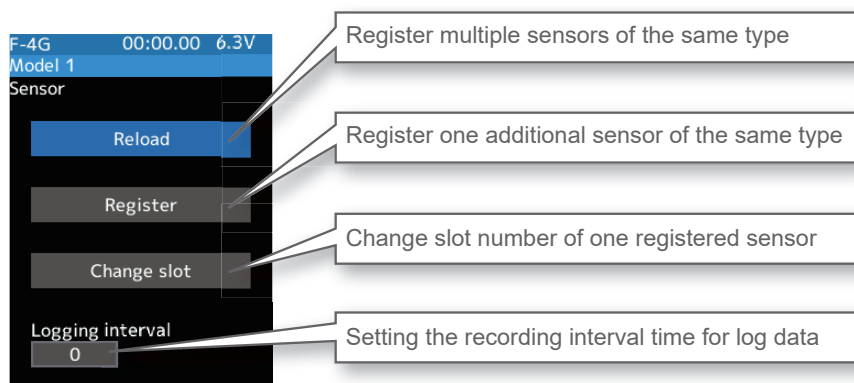
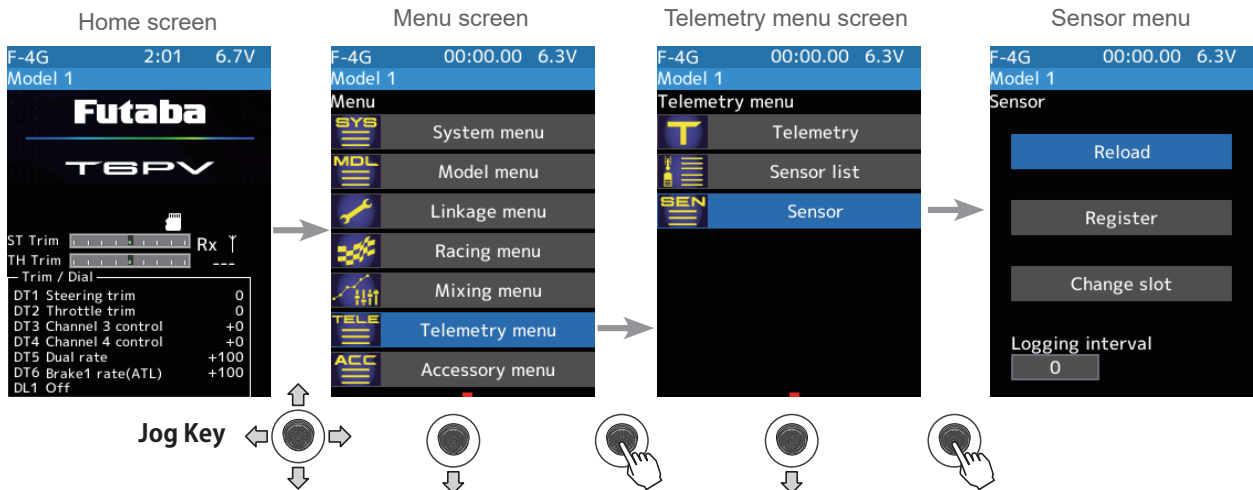

Sensor Reload

When using multiple sensors of the same type, the sensors must be registered in the transmitter. Connect all the sensors to be used to the T6PV as shown in the figure below and register them by the following procedure. The ID of each sensor is registered in the transmitter.

To load the sensor, connect all sensors to be used to the T6PV communication port, as shown below. Also, to clear all sensor registration, execute this [Reload] function without connecting the sensor. The registration is cleared, and all the slots in the sensor list are unregistered.

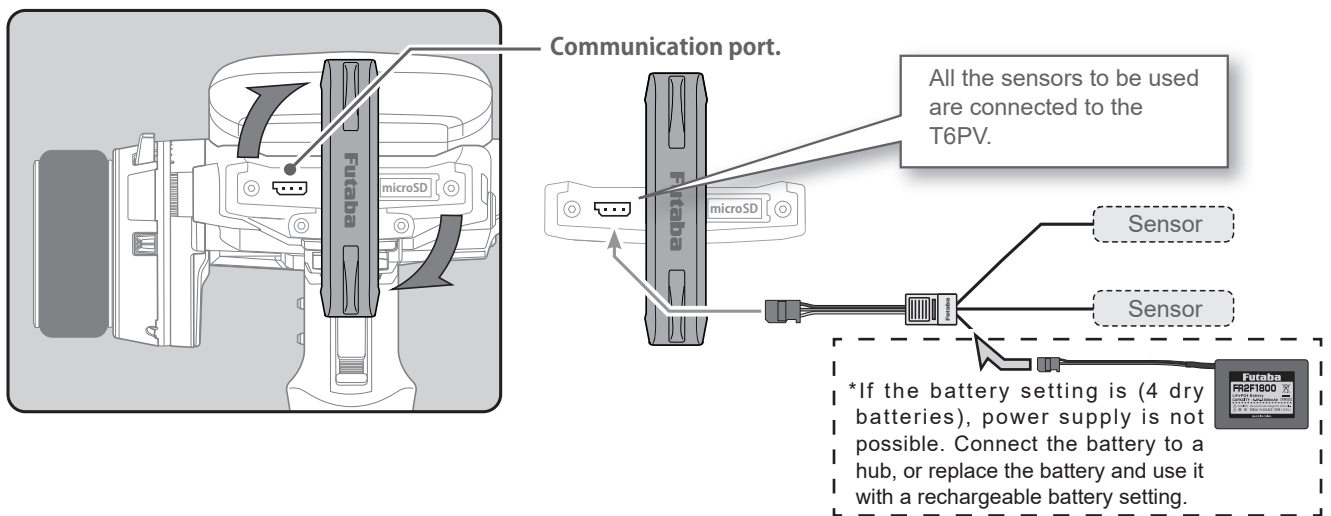

How to change start slot and set empty slot

1 (Start slot selection)

Select [Reload]. The confirmation screen will be displayed. To execute, Select the [Yes] to hear an electronic sound and finish setting. To cancel, select [No] and press jog key it. If "Success" appears on the screen, reload is complete.

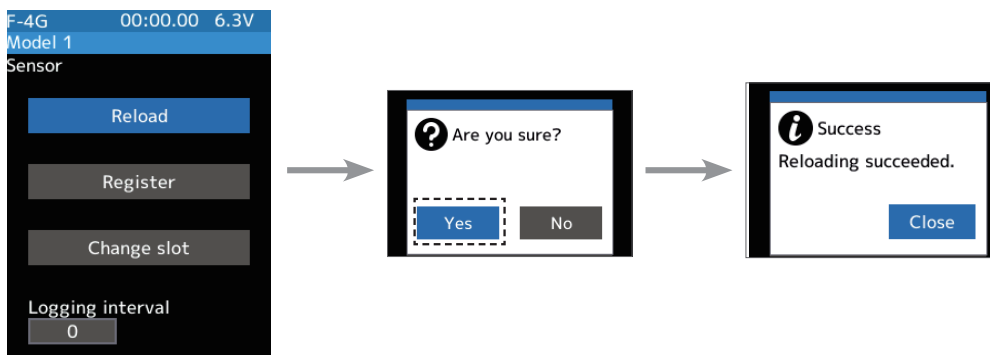

2 When finished, return to the Telemetry screen by pressing the END button, or press and hold the END button to return to the Home screen.

Sensor Register

This function registers additional sensors. Connect the sensor, as shown in the figure, and register as follows. The sensor ID is registered in the transmitter.

This function is set when adding one telemetry sensor of the same type.

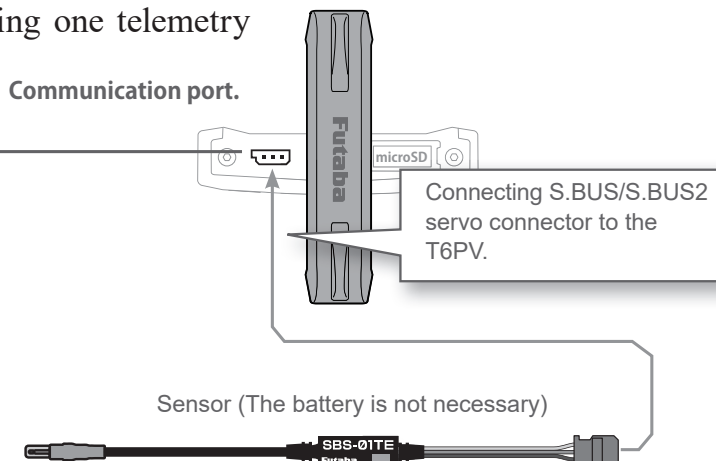
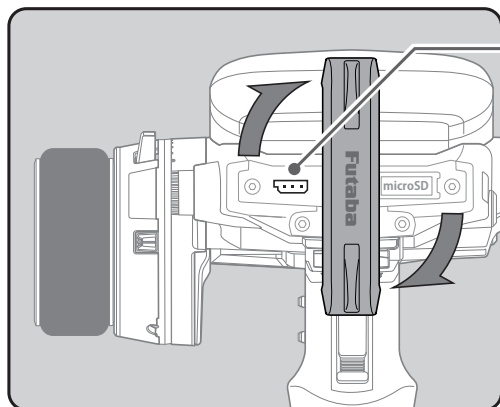

*If the battery setting is (4 dry batteries), power supply is not possible. Connect the battery to a hub, or replace the battery and use it with a rechargeable battery setting.

How to change start slot and set empty slot

1 (Start slot selection)

Select [Register]. The confirmation screen will be displayed. To execute, Select the [Yes] to hear an electronic sound and finish setting. To cancel, select [No] and press jog key it. If "Success" appears on the screen, registration is complete. If registering a sensor that has already been registered is attempted, the message "Failed; The same sensor has been registered" will be displayed. If the message "Failed; The connected sensor is not ready." is displayed, check the sensor connection. If it is securely connected, the sensor or the transmitter may be faulty.

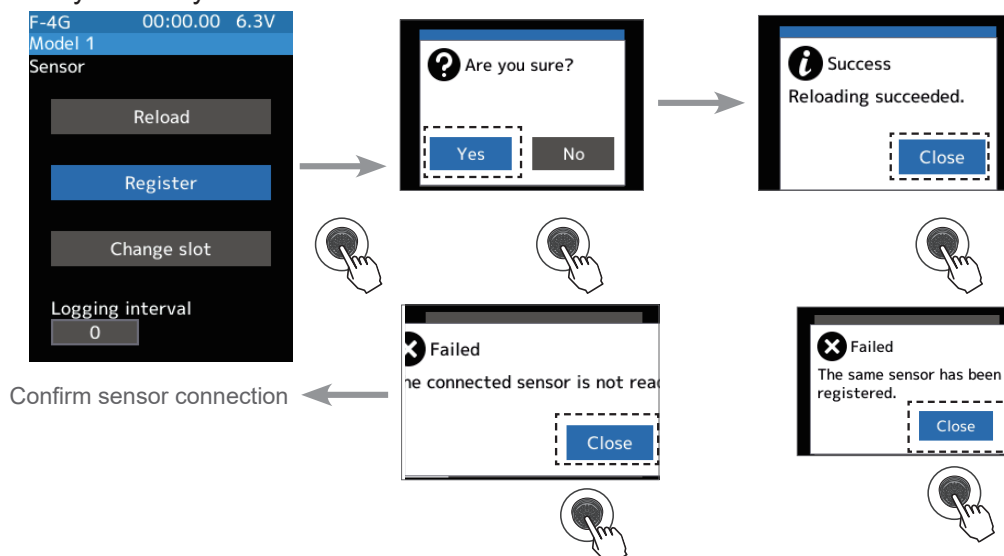

2 When finished, return to the Telemetry screen by pressing the END button, or press and hold the END button to return to the Home screen.

Change Slot

This procedure changes the slot number of the one registered sensor. Connect the sensor as shown in the figure previous page, and change slot number.

This function is set when using multiple telemetry sensors of the same type.

Sensor slot change

1 (Change)

Select [Change slot]. The sensor details screen is displayed. Select [Read]. The confirmation screen will be displayed. To execute, Select the [Yes] to hear an electronic sound and finish reading. To cancel, select [No] and press jog key it. If "Reading succeeded" appears and the current sensor information is displayed.

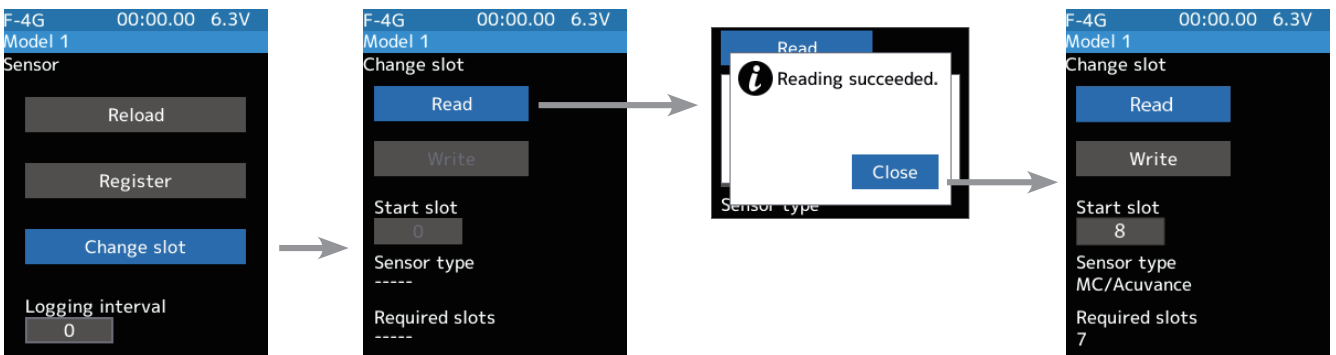

2 (Number setting)

Select the value with jog key of the [Start slot #]. Use the [+] or [-] button to set the start slot number.

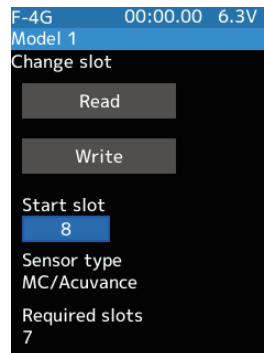

Setting button
Setting with the [+] or [-] button.

3 Use the jog key to select [Write] and press it. When "Writing succeeded" message is displayed, the number change is completed.

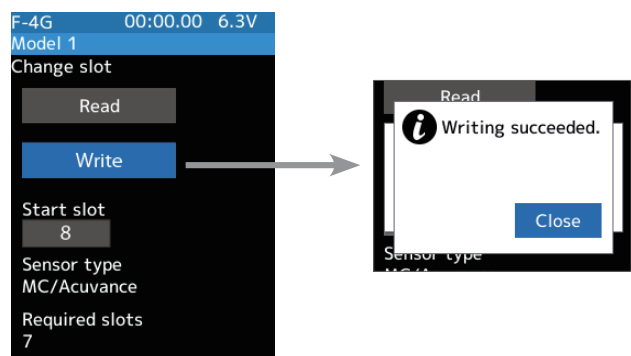

4 When finished, return to the Sensor screen by pressing the END button, or press and hold the END button to return to the Home screen.

Logging interval

This function sets the interval for recording log data.

Logging interval change

- 1 Select [Logging Interval] with the jog key and with the cursor on the setting value, press the [+] or [-] button to set the time.

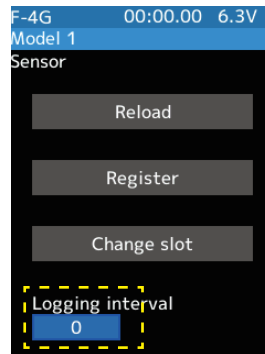

Adjustment buttons

- Adjust with the [+] or [-] button.
- Return to the initial value by press the [+] and [-] button simultaneously

Range

- 0-30 (sec)
- Initial value: 0

Telemetry Instrument panel display on the home screen

Telemetry information on the home screen, graphic Instrument panels can be displayed.

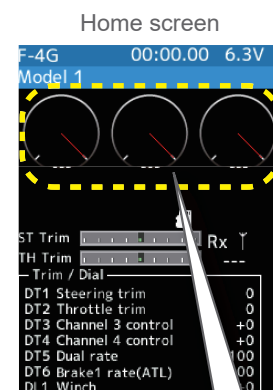
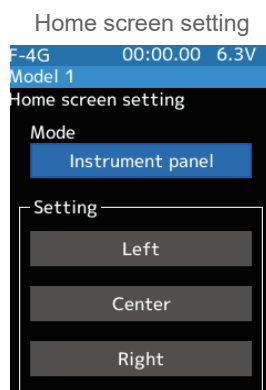
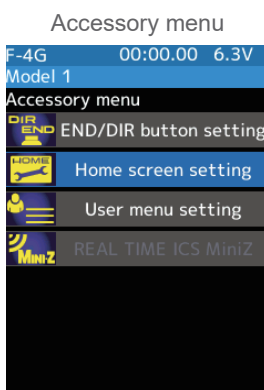

On the [Home screen setting] screen, change the mode to [Instrument panel].

Three meters will be displayed on the home screen. Select the Instrument panel you want to change the settings for and press the jog key.

The Instrument panel displayed on the home screen has a white needle indicating the maximum value and a red needle indicating the current value.



Timer

It allows you to select between one of four timers. Up timer, fuel down timer, lap timer, and lap navigate timer.

Up timer function

- The Up timer can be used to count the time between the start and stop, etc.
- The timer repeatedly starts and stops each time the switch is operated and accumulates the time between each start and stop. (When the count reaches 99-minutes 59-seconds, it returns to 00-minutes 00-seconds and repeats the count.)
- The first start operation can be linked to the throttle trigger.
- An alarm sound can be set. The passage of time is announced by the sounding of a buzzer (beeps) each minute after starting.

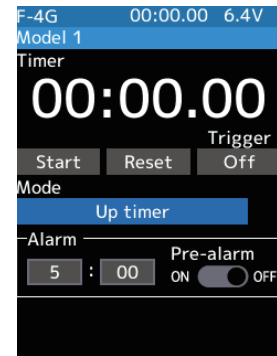

- Alarm: Generates a beep at the set time (minutes).
- Pre-alarm: Alarm advance announcement sound. Sounding begins 10-seconds before the set alarm time.

- After starting, the timer is enabled and can be stopped by switch even when the display switches to another screen.

Fuel down timer function

- The fuel down timer is used primarily to check the refueling time of engine cars. (The remaining time is displayed.)
- Each time the switch is pressed, the timer is restarted, and the set time is counted down. The start time becomes the alarm set time. (When counted down to 00-minutes 00-second, the timer becomes an up timer.)
- The fuel down timer can be initially started by throttle trigger.
- An audible alarm can be set. In addition, the passing of time is indicated by the sounding of a buzzer each minute after starting.

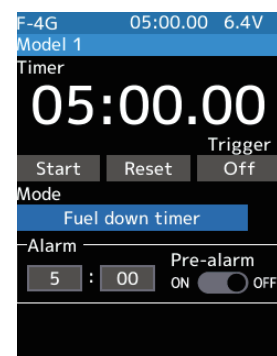

- Alarm: Generates a beep at the set time (minutes).
- Pre-alarm: Alarm advance announcement sound. Sounding begins 10-seconds before the set alarm time.

- After starting, the timer is enabled and can be stopped by switch even when the display switches to another screen.

Lap timer function

Lap timer function

- The lap timer can memorize each lap time of each switch operation. (200 laps)
- The race time can be set. Switch operation after the set time my alarm has elapsed automatically stops the timer. Pre-alarm can also be set. The passage of time is announced by the sounding of a buzzer (beeps) each minute after starting.

-Alarm: Generates a beep at the set time.

Pre-alarm: Starts sounding the set time (second) before the alarm. (beeps)

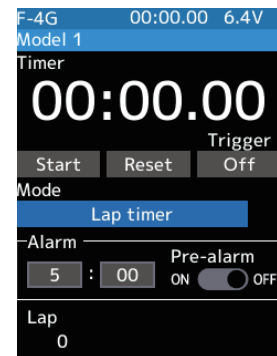

- The first start operation can be linked with the throttle trigger.

(Lap timer operation)

- When lap timer is selected, the number of laps (Lap) and the and current lap time are displayed on the setup screen.

* LAP: Counted up each time the switch is pressed after starting. After the switch is pressed, the lap time display will pause for 3-seconds. Switch operations are not accepted at this time to prevent accidentally re-counting.

* Lap memory: The lamp memory saves the lap times of 200 laps.

* The lap time data stored in the lap memory can be checked at the lap list screen.

Lap navigate timer function

Lap navigate timer function

- This function sounds like a buzzer at a fixed interval after the timer starts. Since only the buzzer can be restarted when the switch is pressed during timer operation, this function can be used as the training run, etc. target time. (Lap navigation alarm) The passage of time is announced by the sounding of a buzzer (beeps) every minute after starting.

- The first start operation can be linked with the throttle trigger.

- The alarm sounds (Alarm/Pre-alarm) can be set separately from the fixed interval buzzer.

- Alarm: Generates a beep at the set time (minutes).

- Pre-alarm: Alarm advance announcement sound. Sounding begins 10-seconds before the set alarm time.

- After starting, the timer is enabled and can be stopped by switch even when the display switches to another screen.

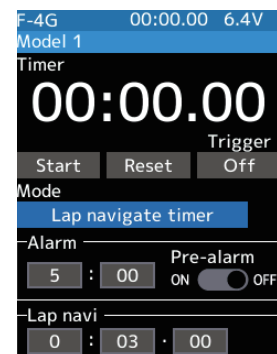



ACCESSORY MENU

How to set the timer

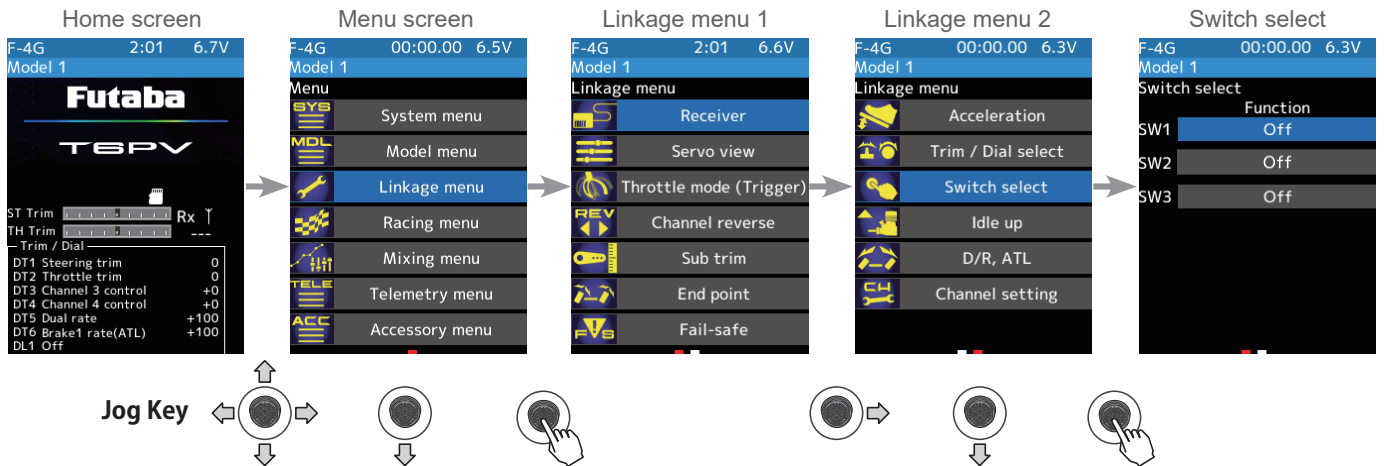

■ Example of starting a timer with SW3

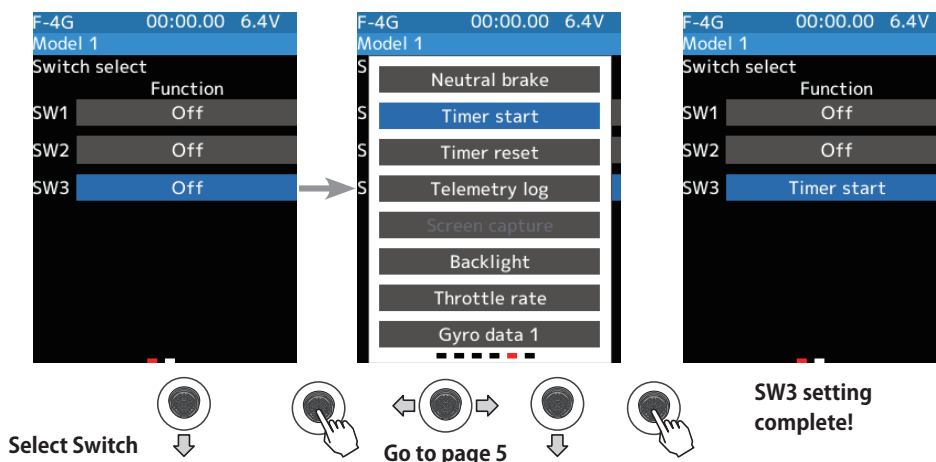

Ex. SW3 start/stop the timer

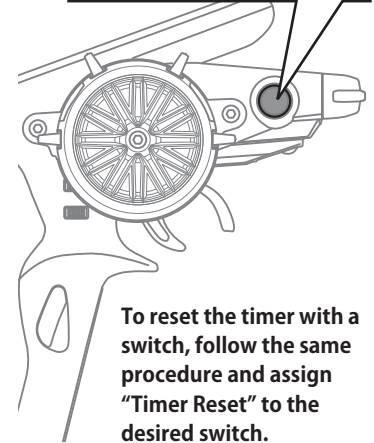

To reset the timer with a switch, follow the same procedure and assign "Timer Reset" to the desired switch.

Timer type selection

1 (Timer type selection)

Use the jog key to move the cursor to "Mode" and press it. A list of timer types will be displayed, so use the jog key to select the timer type and press it.

- Up timer
- Fuel down timer
- Lap timer
- Lap navigate timer

Setting type

- Select with the jog key and press.

Time display
 Minute display (min)
 Second display (sec)
 1/100-second display

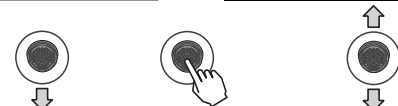
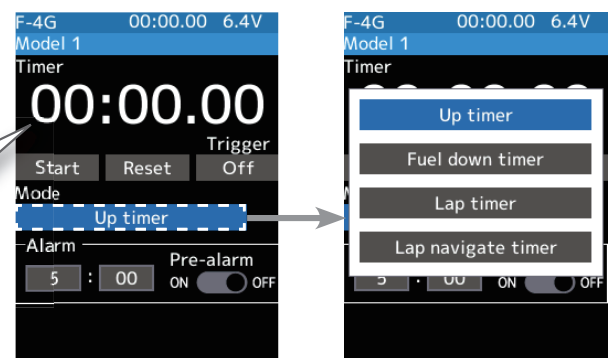

2 When finished, return to the Accessory menu screen by pressing the END button, or press and hold the END button to return to the Home screen.

Using the Up timer

(Preparation)

Select the "Up timer" from the timer type list and press jog key.

1 (Alarm time setting)

Select the value with jog key of the "Alarm time". Use the [+] or [-] button to set the time amount.

(Pre-alarm setting)

Use the jog key to select (ON) or (OFF) of pre-alarm and use the [+] or [-] button to set ON/OFF.

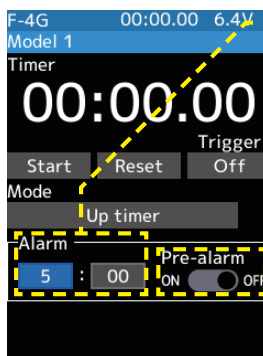

Alarm time

- OFF, 1~99-minutes
- Initial value: 5-minutes
- Adjust with the [+] or [-] button.
- Return to the initial value by press the [+] or [-] button simultaneously

Pre-alarm time

- OFF, ON
- Initial value: OFF
- Use the [+] or [-] button to set (ON)/(OFF).

2 (Timer start/stop operation)

When the switch (Timer start) assigned by switch select function is pressed, the timer starts. When you press the switch (Timer start) or [Start]/[Reset] on the screen during timer operation, the timer stops.

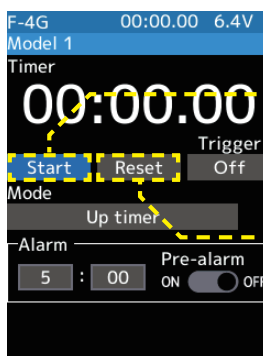

Start/Stop

- Select with jog key and press

Stop/Reset

- Select with jog key and press

- How to start by trigger operation.

Use the jog key to select the trigger [OFF] and press it to display [Ready]. This is the state waiting for the trigger to operate. When you operate the trigger to the forward side, the timer starts. The stop is the same as when starting with a switch.

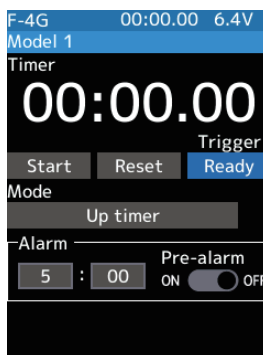

OFF → Ready

- Select with jog key and press

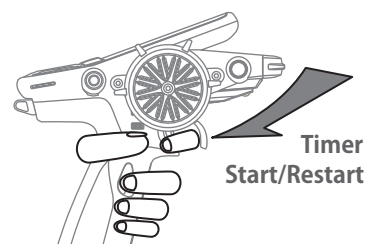

3 (Timer reset operation)

With the timer stopped, press the switch (timer reset) set by the Switch select function, or Use the jog key to select [Reset] and press it. The timer is reset with a beeping sound.

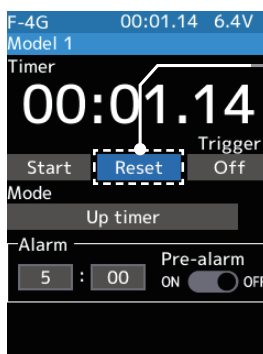

Timer reset

- Select with jog key and press

Using the fuel down timer

(Preparation)

Select the "Fuel down timer" from the timer type list and press jog key.

1 (Alarm time setting)

Select the value with jog key of the "Alarm time". Use the [+] or [-] button to set the time amount.

(Pre-alarm setting)

Use the jog key to select (ON) or (OFF) of pre-alarm and use the [+] or [-] button to set ON/OFF.

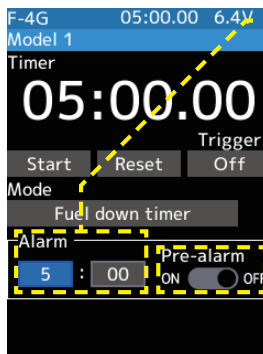

Alarm time

- OFF, 1~99-minutes
- Initial value: 5-minutes
- Adjust with the [+] or [-] button.
- Return to the initial value by press the [+] or [-] button simultaneously

Pre-alarm time

- OFF, ON
- Initial value: OFF
- Use the [+] or [-] button to set (ON)/(OFF).

2 (Timer start/stop operation)

When the switch (Timer start) assigned by switch select function is pressed, the timer starts. When you press the switch (Timer start) or [Start]/[Reset] on the screen during timer operation, the timer stops.

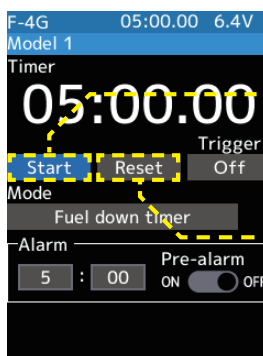

Start/Stop

- Select with jog key and press

Stop/Reset

- Select with jog key and press

- How to start by trigger operation.

Use the jog key to select the trigger [OFF] and press it to display [Ready]. This is the state waiting for the trigger to operate. When you operate the trigger to the forward side, the timer starts. The stop is the same as when starting with a switch.

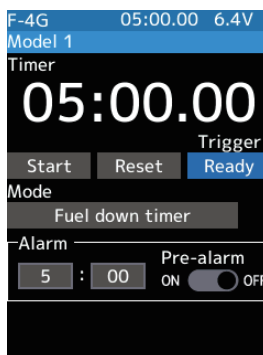

OFF → Ready

- Select with jog key and press

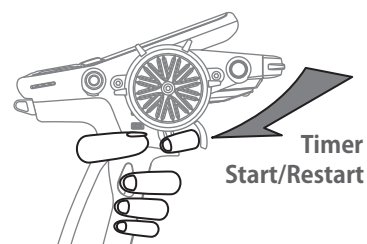

3 (Timer reset operation)

With the timer stopped, press the switch (timer reset) set by the Switch select function, or Use the jog key to select [Reset] and press it. The timer is reset with a beeping sound.

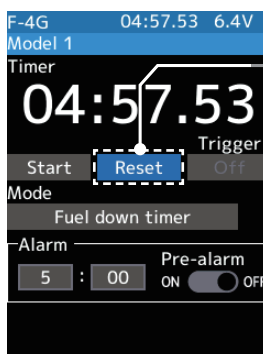

Timer reset

- Select with jog key and press

Using the lap timer

(Preparation)

Select the "Up timer" from the timer type list and press jog key.

1 (Alarm time setting)

Select the value with jog key of the "Alarm time". Use the [+] or [-] button to set the time amount.

(Pre-alarm setting)

Use the jog key to select (ON) or (OFF) of pre-alarm and use the [+] or [-] button to set ON/OFF.

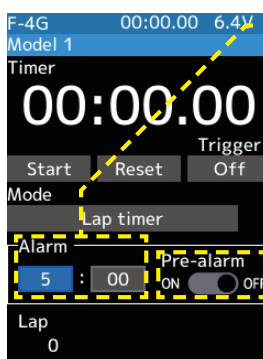

Alarm time

- OFF, 1~99-minutes
- Initial value: 5-minutes
- Adjust with the [+] or [-] button.
- Return to the initial value by press the [+] or [-] button simultaneously

Pre-alarm time

- OFF, ON
- Initial value: OFF
- Use the [+] or [-] button to set (ON)/(OFF).

2 (Timer start operation)

Perform the start and lap count operations with the switch ("Timer start") assigned by function select switch function.

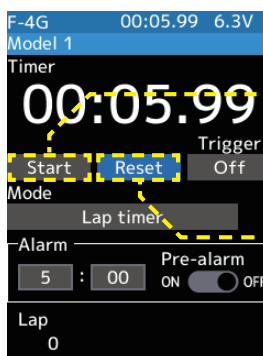

Start/Stop

- Select with jog key and press

Stop/Reset

- Select with jog key and press

- How to start by trigger operation.

Use the jog key to select the trigger [OFF] and press it to display [Ready]. This is the state waiting for the trigger to operate. When you operate the trigger to the forward side, the timer starts. The stop is the same as when starting with a switch.

* You cannot start it unless you reset the last lap timer. If the lap timer is reset, the lap list is also cleared

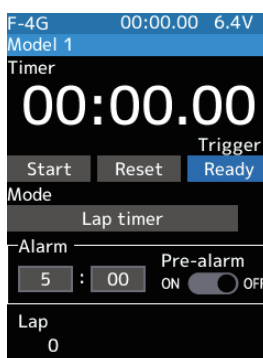

OFF → Ready

- Select with jog key and press

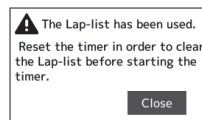
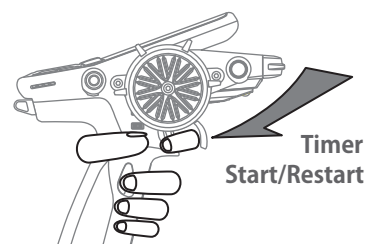

If you start without resetting the last lap timer, it will be cleared.

3 (Timer stop and lap reset operation)

When the lap count switch or ("Timer reset") switch is pressed after the time set by "Alarm" has elapsed and the lap time, total time, and average lap time are saved and checked. If the switch ("Timer reset") set by switch select function is pressed, the timer is reset.

When a switch is not set, Select the [Reset] on the screen. The timer is reset with a beeping sound.

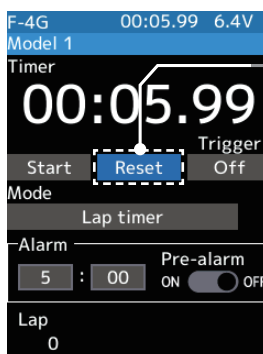

Timer reset

- Select with jog key and press

- The lap list will be cleared when the timer is reset.

Using the lap navigate timer

(Preparation)

Select the "Lap navigate timer" from the timer type list and press jog key.

1 (Alarm time setting)

Select the value with jog key of the "Alarm time". Use the [+] or [-] button to set the time amount.

(Pre-alarm setting)

Use the jog key to select (ON) or (OFF) of pre-alarm and use the [+] or [-] button to set ON/OFF.

(Lap navigation time setting)

Select the value with jog key of the "Lap navi". Use the [+] or [-] button to set the time amount.

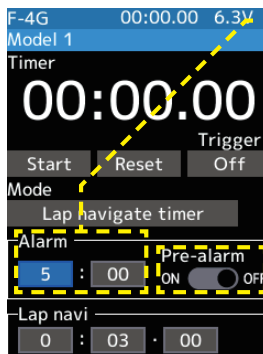

Alarm time

- OFF, 1~99-minutes
- Initial value: 5-minutes
- Adjust with the [+] or [-] button.
- Return to the initial value by press the [+] or [-] button simultaneously

Pre-alarm time

- OFF, ON
- Initial value: OFF
- Use the [+] or [-] button to set (ON)/(OFF).

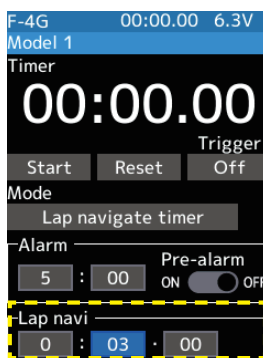

Lap navi time

- OFF, 1~99-minutes
- Initial value: 3-minutes

2 (Timer start operation)

Perform the start and lap count operations with the switch ("Timer start") assigned by function select switch function.

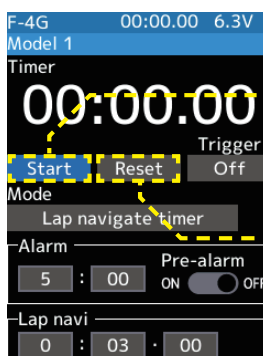

Start/Stop

- Select with jog key and press

Stop/Reset

- Select with jog key and press

- How to start by trigger operation.

Use the jog key to select the trigger [OFF] and press it to display [Ready]. This is the state waiting for the trigger to operate. When you operate the trigger to the forward side, the timer starts. The stop is the same as when starting with a switch.

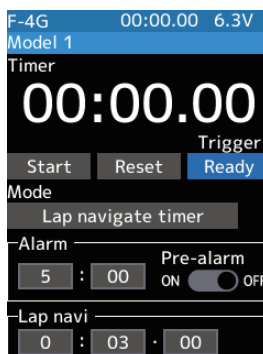

OFF → Ready

- Select with jog key and press

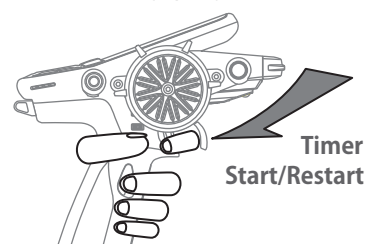

* When your own lap time is less than the target time, and the lap counts overlap, the lap navigation alarm timing is too big. The alarm timing can be corrected by pressing the switch ("Timer start") during measurement.

- (Timer reset operation)
With the timer stopped, press the switch (timer reset) set by the Switch select function, or Use the jog key to select [Reset] and press it. The timer is reset with a beeping sound.

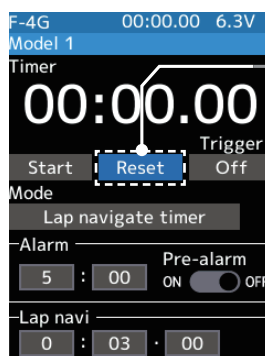

Timer reset
- Select with jog key and press



Lap List

Call the Lap list when checking the lap memory data (each lap time) memorized by lap timer operation.

- After the lap timer is started, the lap time is sequentially memorized at each switch operation.
- The total time and average time are displayed. The faster time is displayed in red characters.
- Lap time data is saved in each model data.
- Up to 200 laps can be saved.
- If the lap timer is reset, the lap list is also cleared.

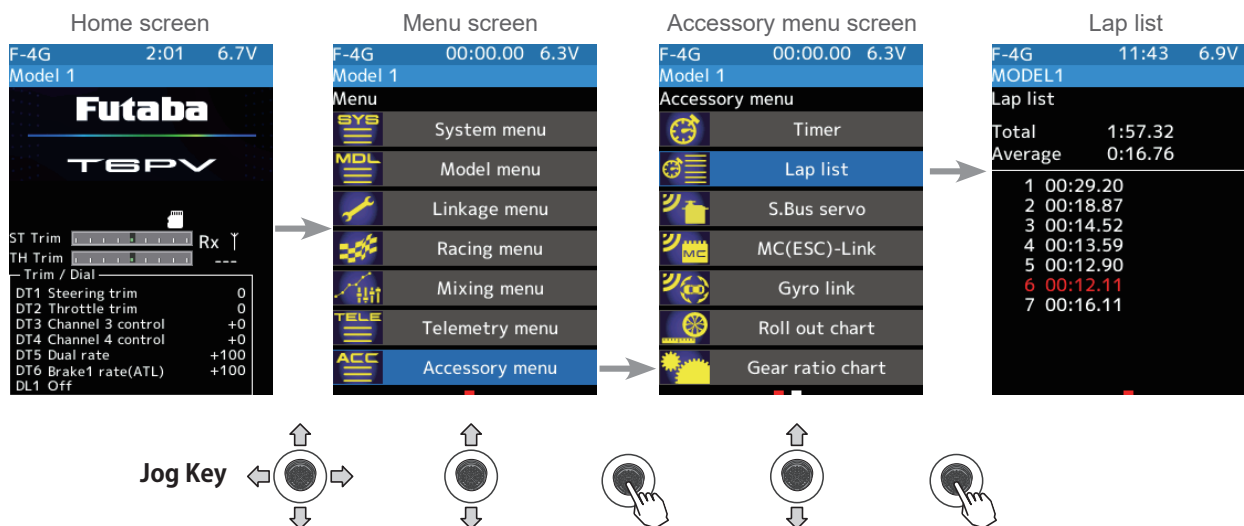

Using the lap memory

- (Lap memory check)
The lap time list displays 40 laps per page and 200 laps maximum on two pages. If there is a list on page 2, Operate the jog key left and right to change the display of the page.
- When finished, return to the Accessory menu screen by pressing the END button, or press and hold the END button to return to the Home screen.



S.BUS servo

This function is a unique function that allows the Futaba S.BUS/S.BUS2 servo parameter changes to be set by the T6PV transmitter. However, some data changes require a PC and S-Link software. There are two ways to set Futaba S.BUS/S.BUS 2 servo directly by connecting it to the communication port of the transmitter and wirelessly setting it with the servo still connected to the receiver. When setting with wires, please use an optional extension cord for servo as necessary. (UR/SR mode setting is for T6PV only, it cannot be set with S-Link software.) Also, there are restrictions on wireless settings, so read the following "Notes" below.

-If shutting off the transmitter while the parameters, the servo may fail. Please use this function with sufficient battery power.

- For safety reasons, it is not possible to change between normal mode and UR/SR mode with the wireless setting. To change the mode, connect the servo to the communication port and switch. However, for servos set to UR/SR mode, UR(1-4)/SR(1-3) can be switched by wireless setting.

- Wireless settings cannot be used if a device that converts signals such as gyro and FSU (Failsafe Unit) etc. are connected between the receiver and the servo.

-A receiver compatible with the wireless setting function is required. As of Jan. 2025, R404SBS/R404SBS-E/R334SBS(version 2.0 or later.)/R334SBS-E(version 2.0 or later.) is compatible with wireless setting.

-If the T6PV battery type is a dry 4-cell battery, the SBUS servos connected to the T6PV will not be powered. Connect a servo compatible battery to the hub. When the battery is connected, the supply of power from the transmitter automatically stops.

-A power supply is not required only if the T6PV battery type is other than dry 4-cell and the HV servo is used. Since an overvoltage will be applied to servos other than this, connect the corresponding battery to the servo. When the battery is connected, the supply of power from the transmitter automatically stops.

-In the wireless setting, reading / writing / reset / initialization may take a long time or may fail depending on the surrounding radio wave environment. If it fails, try again.

WARNING

- ⚠ In the wireless setting, there is a danger that a car (boat) can become unexpectedly uncontrollable, because the servo temporarily stops working during communication. For safety, in case of electric car (boat), please set with driving wheel (boat propeller) not touching the road surface (water surface). Also, in the case of an internal combustion engine car (boat), be sure to stop the engine before entering wireless set-up mode.

CAUTION

- ⚠ When connecting an S-BUS servo that does not support high voltage, connect a battery matched to the servo specifications.

High voltage servo support voltage is supplied from the transmitter. If a servo that does not support high voltage is connected, unreasonable force will be applied to the servo and will cause trouble.

- ⚠ Do not disconnect the servo connector or turn off the transmitter power while writing parameters.

It may cause the servo to malfunction.

Connection between wired transmitter and servo

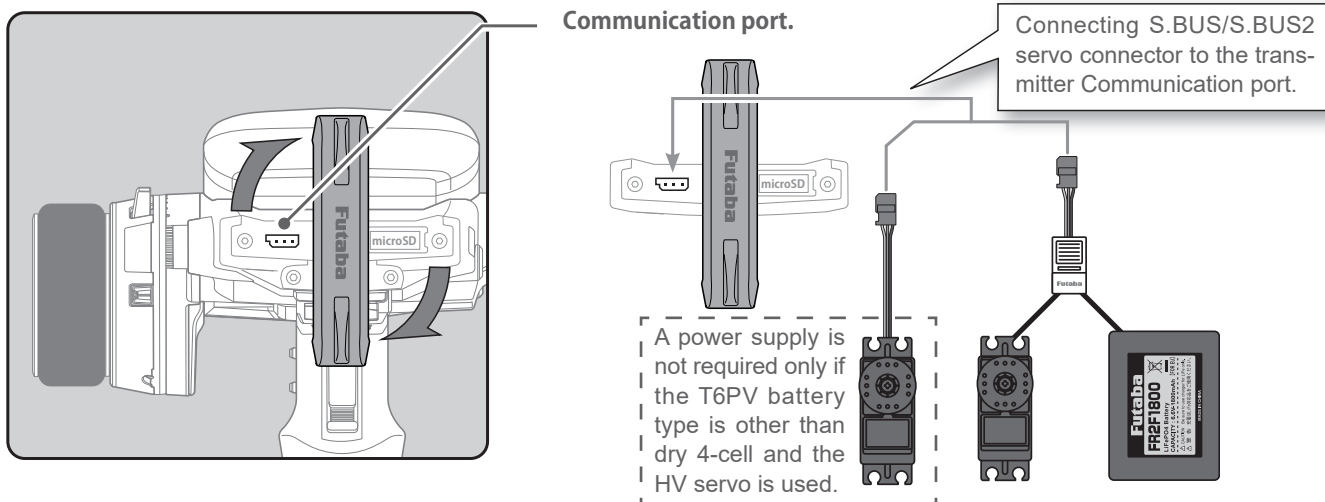

The connection between the wireless receiver and servo

- Reference

When using "S.BUS/S.BUS2" servo with steering mixing (Mixing menu) with a twin servo specification car such as 1/5 GP car, in the channel setting function (Linkage menu), the 1st channel and 2nd channel are set to steering, both servos can be wirelessly set.

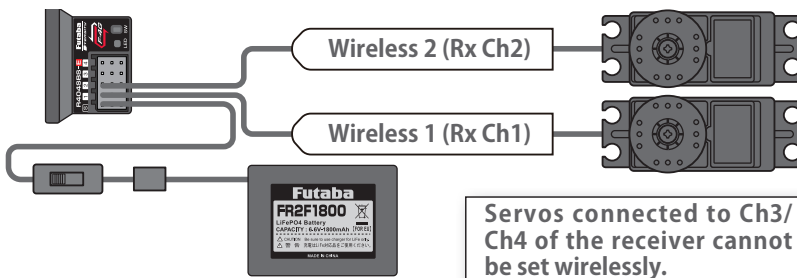

Home screen

Menu screen

Accessory menu

S.BUS servo

Jog Key

Using the S.BUS servo function

(Preparation)

- Connect S.BUS or S.BUS2 servo with reference to the above connection diagram.
- If the T6PV battery type is a dry 4-cell battery, the servo battery will also be connected to the hub.
- Be sure to use the wired method when changing the setting of UR/SR mode. Mode cannot be changed with the wireless setting.

1

If it is wired, turn on the power switch DSP or PWR of the transmitter.

In the case of wireless, turn on the PWR side of the power switch. Wireless settings cannot be used on the DSP side. Turn on the battery switch of the receiver and check the operation of the servo. The S.BUS servo screen is displayed.

2 (S.BUS/S.BUS2 servo read)

Execute this function to read the connected servo type and the data currently set at the servo.

Select and press [Read] button. The notes on the wireless settings are displayed. Select and press [Continue] button.

Once this screen is displayed, it will not be displayed again until you turn the power back on. Next, select and press the channel in which the servo to be set is connected and read the setting data from the servo.

- Communication port: 6PV communication port (conventional wired setting).
- Wireless 1 (Rx Ch1): Receiver channel 1
- Wireless 2 (Rx Ch2): Receiver channel 2

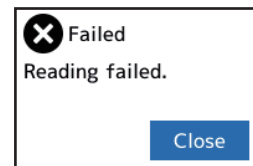
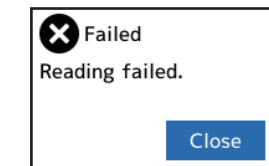
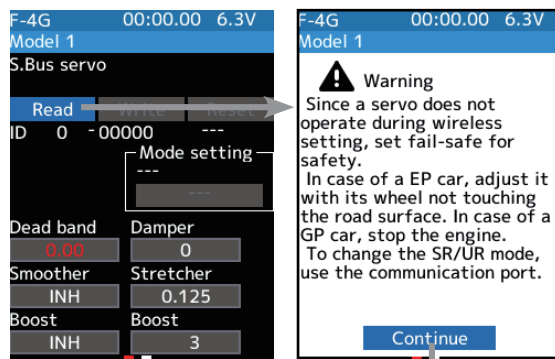
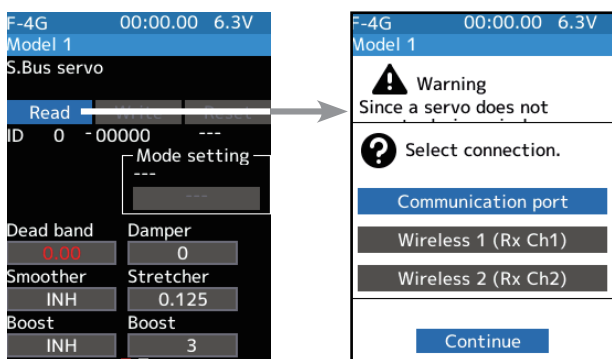

- "Reading succeeded" is displayed on the screen, and the servo's ID cord and currently set contents are read.
- If "Failed" is displayed on the screen, communication with the servo is not being performed normally.
- Check the T6PV and servo connection or receiver and servo connection to servo and repeat [Read]. (Check receiver power supply etc.)

3 (Writing to S.BUS/S.BUS2)

Execute this function to write the setting data to the servo. Select and press [Write]; the confirmation screen is displayed. To execute, Select and press [Yes] to hear an electronic sound and finish setting. To cancel, Select [No] and press jog key it.

- "Writing succeeded" is displayed on the screen, and the setting data is written to the servo.
- If "Failed" is displayed on the screen, communication with the servo is not being performed usually. Check the T6PV and servo connection or receiver and servo connection to the servo and repeat [Write]. (Check receiver power supply, etc.)

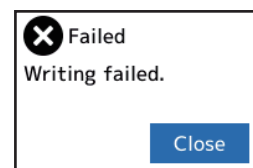
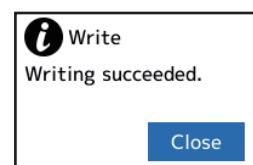
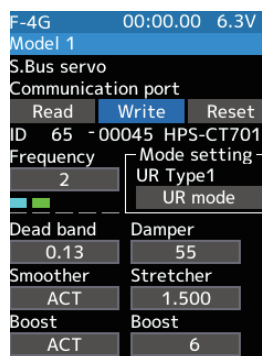

4 (Initialization)

Write the factory set servo setting data to the connected servo. Select and press [Reset]; the confirmation screen is displayed. To execute, Select and press [Yes] to hear an electronic sound and finish setting. To cancel, select [No] and press jog key it.

- "Writing succeeded" is displayed on the screen, and then initialize a setting data is written to the servo.
- If "Failed" is displayed on the screen, communication with the servo is not being performed usually. Check the T6PV and servo connection or receiver and servo connection to servo and repeat [Reset]. (Check receiver power supply etc.)

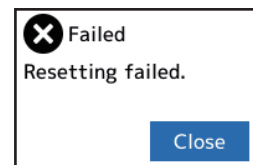
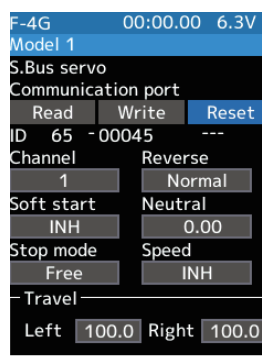

Display data list

- The type and data of the loaded servo are displayed. Since there are two setting items, use the jog key left and right to turn the pages.

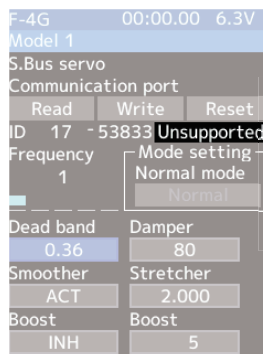
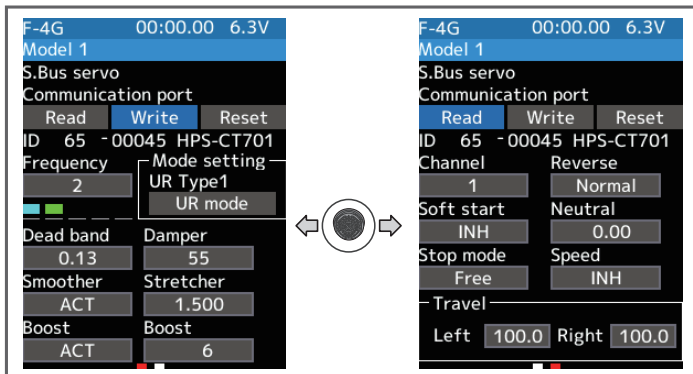

When the connected servo type is not compatible with the UR/SR mode, "Unsupported" is displayed

- Do not plug in or disconnect servos, or connect other servos while keeping the screen where data was read by [Read]. Be sure to connect the servo in the state where [Write] or [Reset] is finished, or press the HOME button to access the accessory menu screen.
- The loaded data cannot be written to another servo.

UR/SR mode setting (Wired only)

- (Writing to the servo)
Select [UR/SR mode] or [Normal mode] of the UR/SR mode setting. A confirmation screen of "Notes on UR/SR setting" is displayed, so read carefully and select the [Normal mode] or [UR/SR mode].

- When [Normal mode] is selected, "Writing succeeded" is displayed on the screen, and the setting data is written to the servo.
- If "Failed" is displayed, communication with the servo is not performed usually. Check the connection between the T6PV and the servo, and then execute the write operation again.

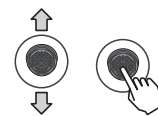
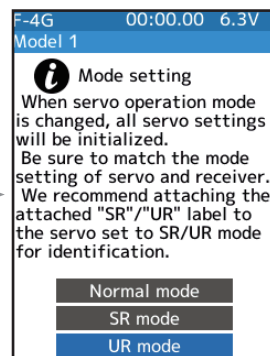
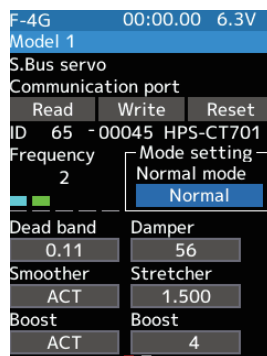

- (When UR mode is selected by writing to the servo)
In the confirmation screen of "Notes on UR setting", Select the [UR mode] with the jog key and press, the screen for selecting the UR type 1-4 is displayed. For different UR modes are prepared. (Please repeat the test and choose the type.)

- "Writing succeeded" is displayed on the screen, and the setting data is written to the servo. If "Failed" is displayed, communication with the servo is not performed usually. Check the connection between the T6PV and the servo, and then execute the [Write] operation again.
- For the servo set to UR mode, affix the supplied UR label so that UR mode can be reconized.

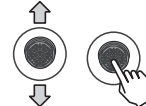
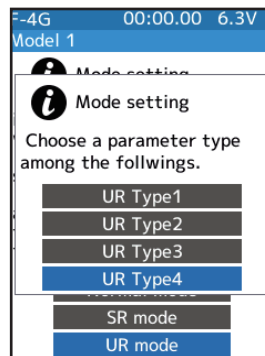

The type of servo and the set UR type are displayed.

- ⊗ Do not connect any servos that are on UR/SR mode to a receiver via S.BUS/S.BUS2 terminal. You cannot use an UR/SR servo in the SBUS/S.BUS2 ports, as they are not compatible with UR/SR mode. The UR/SR servo can be damaged if it is connected to the S.BUS/S.BUS2 ports.

UR mode setting (Wired only)

ULTRA RESPONSE

The T6PV F-4G system provides the fastest response when used in combination with the Futaba UR Servo. Follow the steps below to switch the settings. UR mode can only be used with F-4G systems.

Procedure for changing T6PV settings

It is necessary to relink and restart the receiver power supply after changing the settings.

- 1 Set the transmitter "PWR" side power switch to ON. From the Home screen, Operate the jog key in either direction. Next, select [Receiver] at the Linkage menu and access the setup screen shown below by press the jog key.

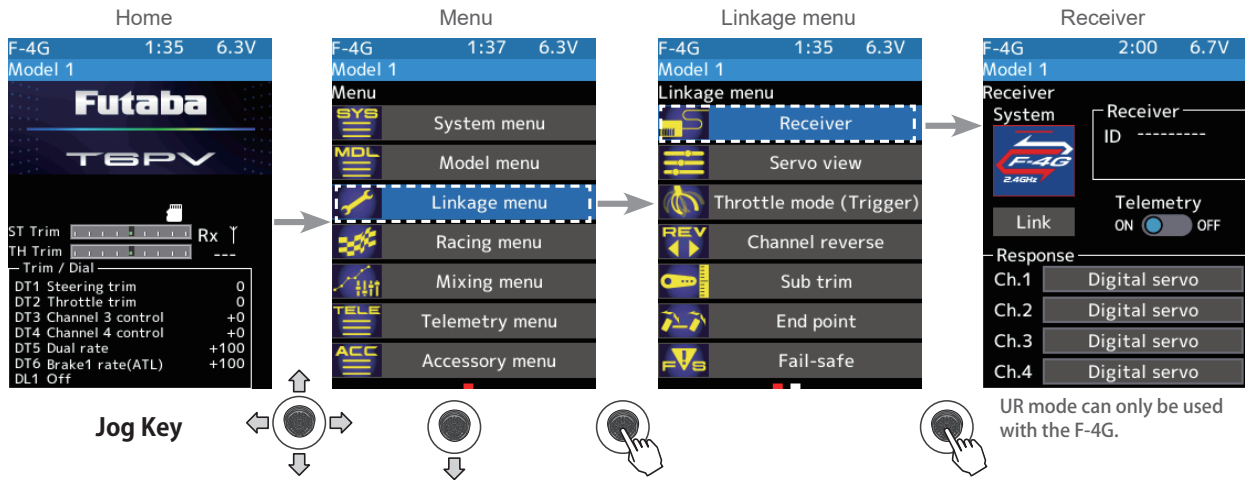

- 2 In the case of F-4G, 4 types of response settings can be set for each channel according to the servo used. Select UR mode when using the UR servo set to UR mode.

- UR mode: UR servo (Set to UR mode)
- SR mode: UR/SR servo (Set to SR mode)
- Digital servo
- Analog servo

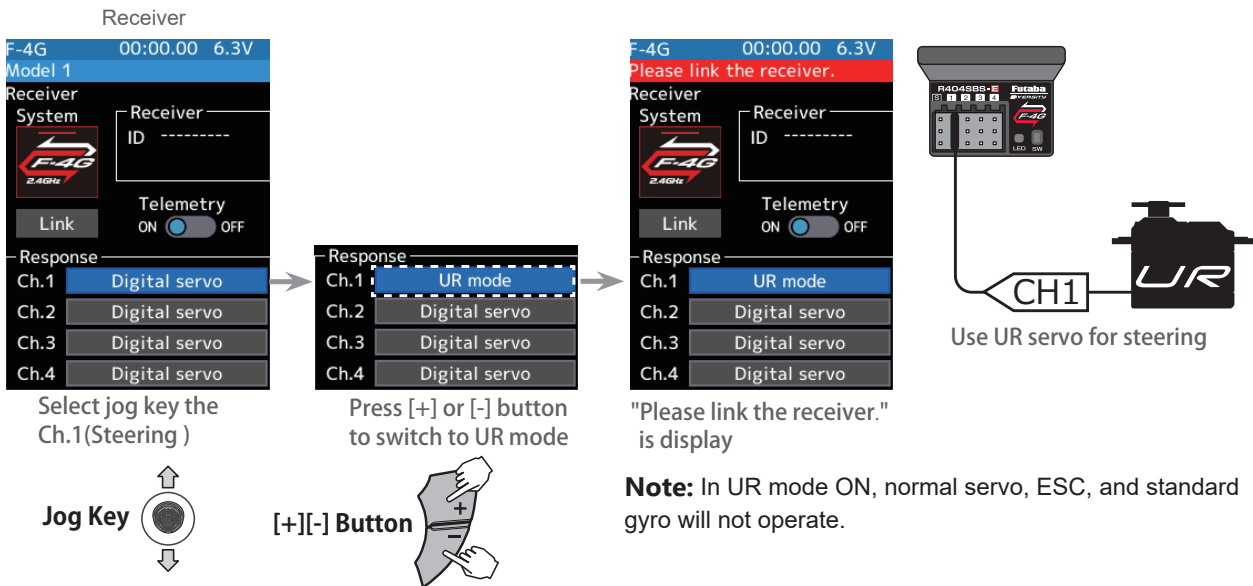

- 3 When using battery fail-safe, set the Battery Fail-safe Voltage in the "Fail-safe" in the "Linkage menu".

*In the F-4G system, the Battery Fail-safe voltage is set at the time of linking. Relink when changing Battery Fail-safe voltage.



ACCESSORY MENU







- 4 Bring the transmitter and receiver within 50 cm of each other (antennas do not touch) and turn on the receiver power.
- 5 Touch [Link] on the transmitter T6PV screen, you will hear a chime sound and T6PV will enter the link mode for 20 seconds.
- 6 During the 20 seconds link mode, press the receiver for at least 2 seconds. The LED blinks red and then changes to a greenish red → green steady light. When the T6PV makes a beeping sound and the message "Link with receiver" appears on the screen, release the receiver push switch. This ends reading of mutual ID and displays the memorized receiver ID number on the T6PV screen. Power cycle the receiver. If the "Receiver not found" error screen is displayed, linking failed. Check the set contents and repeat the linking operation.
- 7 Once the settings are complete, turn the receiver off and then on again. The response and battery fail-safe voltage settings will take effect after the receiver is restarted.

Receiver mode precautions

Caution

⚠ Be sure to use the T6PV receiver setting and the servo to be used under predetermined conditions.

! Under other conditions, the set will not operate, or the specified performance will not be displayed even if it operates. In addition, it may cause servo trouble. Futaba will not be responsible for problems caused by the use of other than genuine Futaba parts. Use the parts specified in the instruction manual and catalog.

System	Receiver	Response	Usable servo
	R404SBS R404SBS-E	UR mode	• Futaba UR servo 
		SR mode	• Futaba SR servo
		Digital servo	• Futaba Digital servo
		Analog servo	• Futaba Digital servo/Analog servo
 	R334SBS R334SBS-E R324SBS R314SB R314SB-E R304SB R304SB-E R202GF R203GF R204GF-E R214GF-E R2104GF	Digital servo	• Futaba Digital servo
		Analog servo	• Futaba Digital servo/Analog servo
	Receiver for MINI-Z EVO Unit 82042 (KYOSHO)	-	• KYOSHO MINI-Z
	Receiver for MINI-Z EVO2 Unit 82044, 82046 (KYOSHO)	-	• KYOSHO MINI-Z
	Mini-Z FHSS compatible (KYOSHO) (Use F5-RM005 module for transmitter)	-	• KYOSHO MINI-Z

- For servos for which the operation mode can be set, change the servo operation mode according to the system to be used. If the operating modes of the system and servo are different, it will fail.
- Use UR servo (Set to UR mode) for UR mode. Use SR/UR servo (Set to SR mode) for SR mode.
- When the UR(SR) mode is ON, it is exclusively for our UR(SR) compatible servo. Using a servo other than the UR(SR) compatible servo may cause the servo or receiver to malfunction.
- If a normal servo is connected to a CH with UR/SR mode ON, there is a risk of damage.
- Do not connect UR/SR servo (set to UR/SR mode) and analog servo in digital servo mode.
- Do not connect UR/SR servo (set to UR/SR mode) in analog servo mode.
- UR/SR servo can be used digital or analog when set to normal mode.
- Connecting an UR/SR mode compatible servo set to UR/SR mode to the S (S.BUS2 port) may cause malfunction of the servo or receiver.
- Receiver battery: Matched to the ratings of the receiver and connected servo (dry cell battery cannot be used).
- Fail-safe Unit cannot be used because the system is different. Use the fail-safe function of the transmitter.

UR servo setting change procedure

The initial setting of the UR servo is normal mode.

To use it in UR mode, you need to switch to UR mode by following the steps below.



The initial setting is Normal mode

The following modes can be selected for the UR servo.

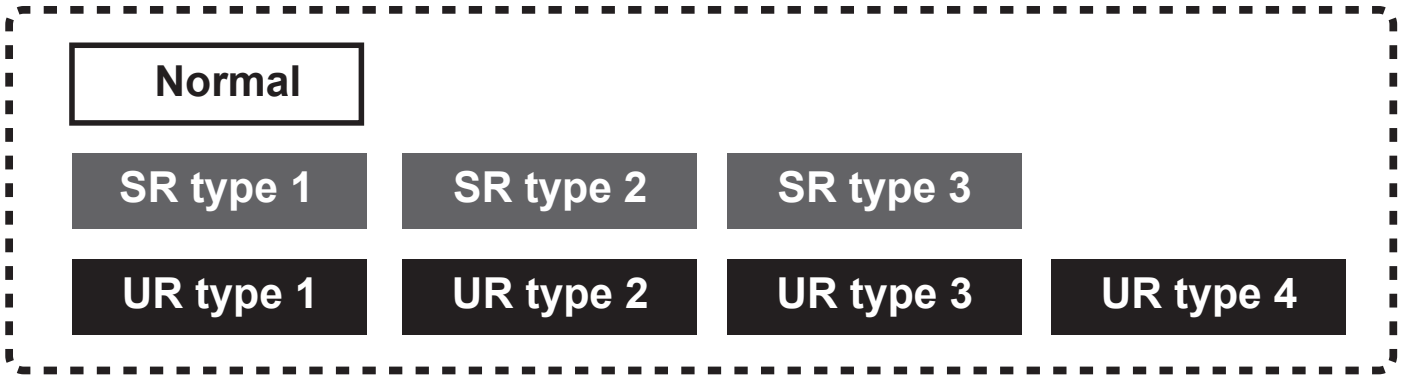

1 Connect the UR servo as shown.

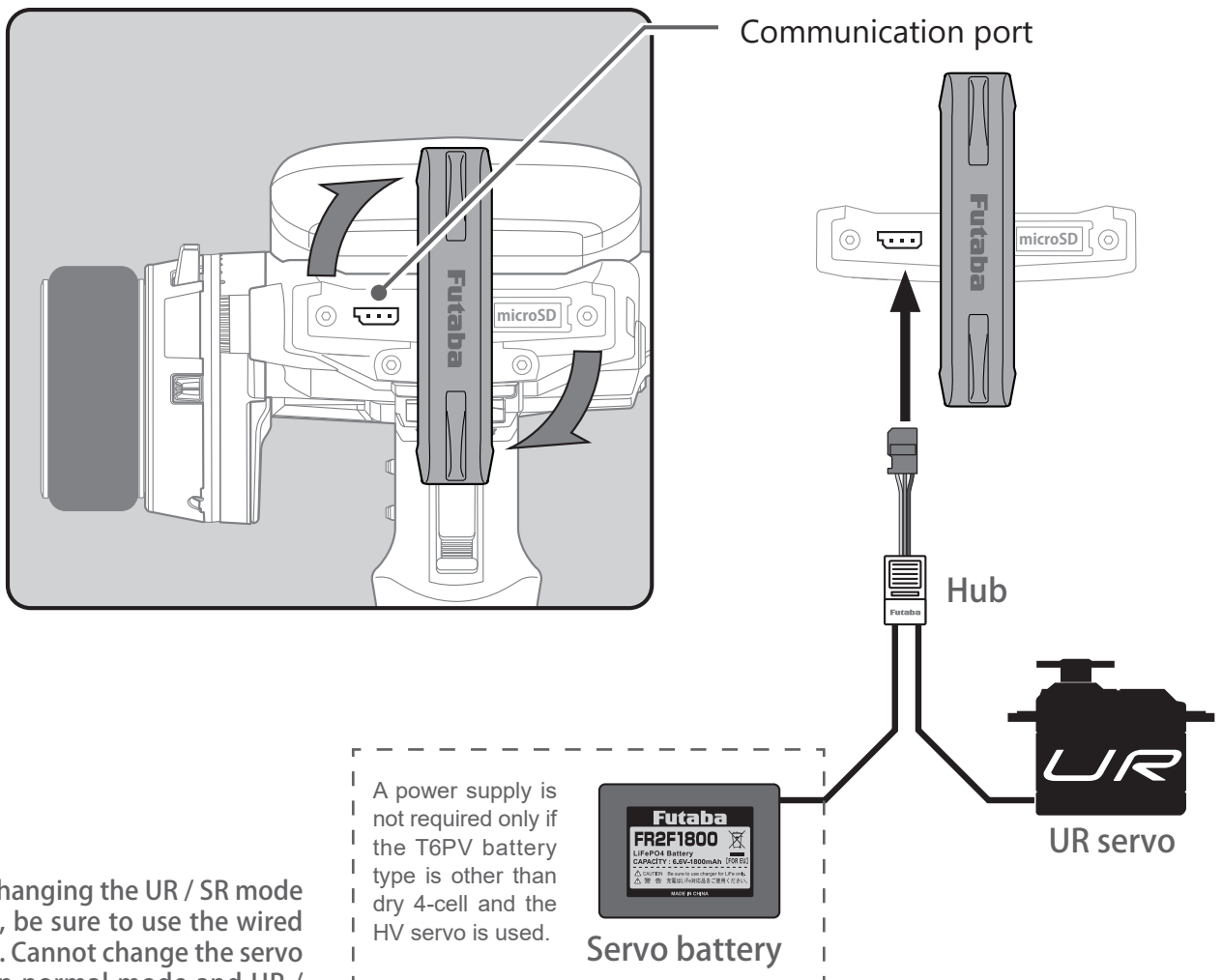

- When changing the UR / SR mode settings, be sure to use the wired method. Cannot change the servo between normal mode and UR / SR mode in the wireless setting. Once set to UR mode, switching between UR1 / UR2 / UR3 / UR4 can be done wirelessly.

2 Turn on T6PV and call Menu → Accessories Menu → S.Bus servo screen.

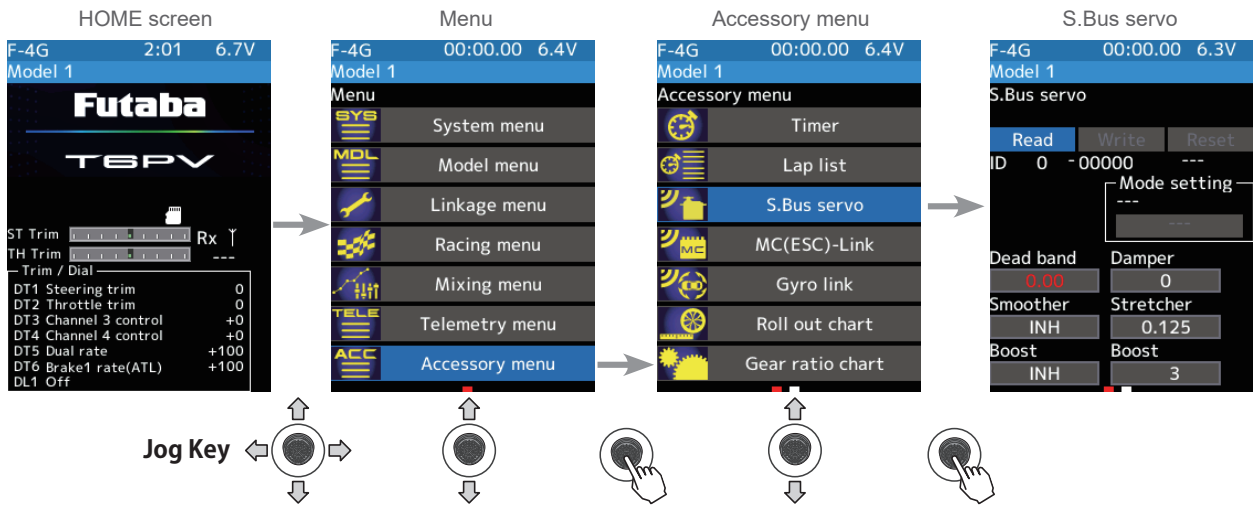

3 Read the connected UR servo data into the T6PV.

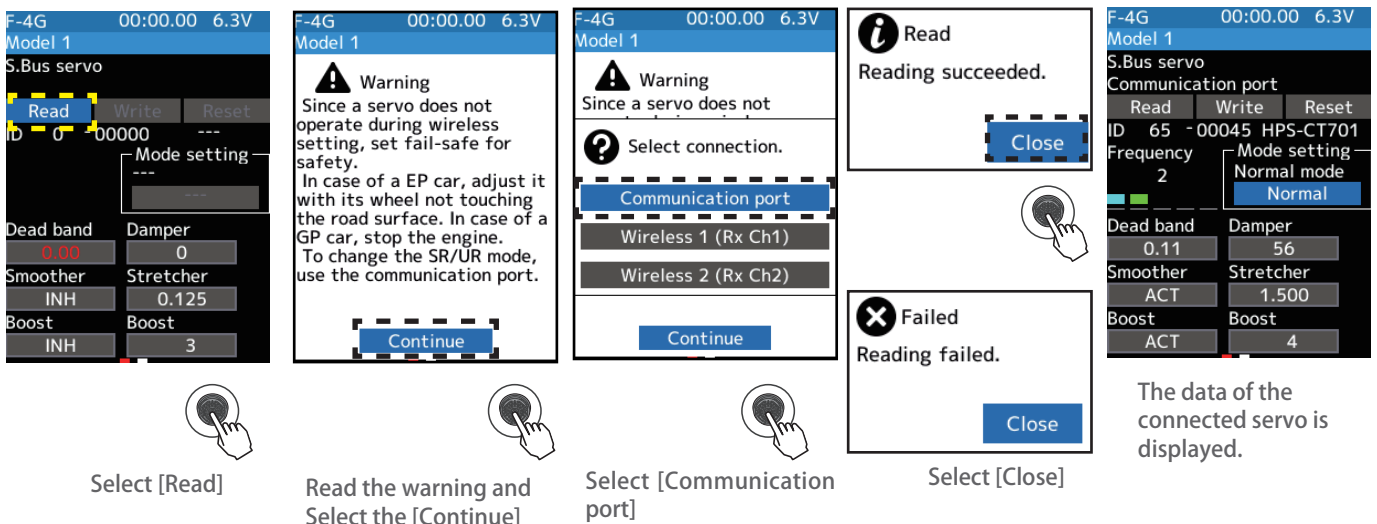

4 Change to UR mode, select UR type, and write data to the connected UR servo.

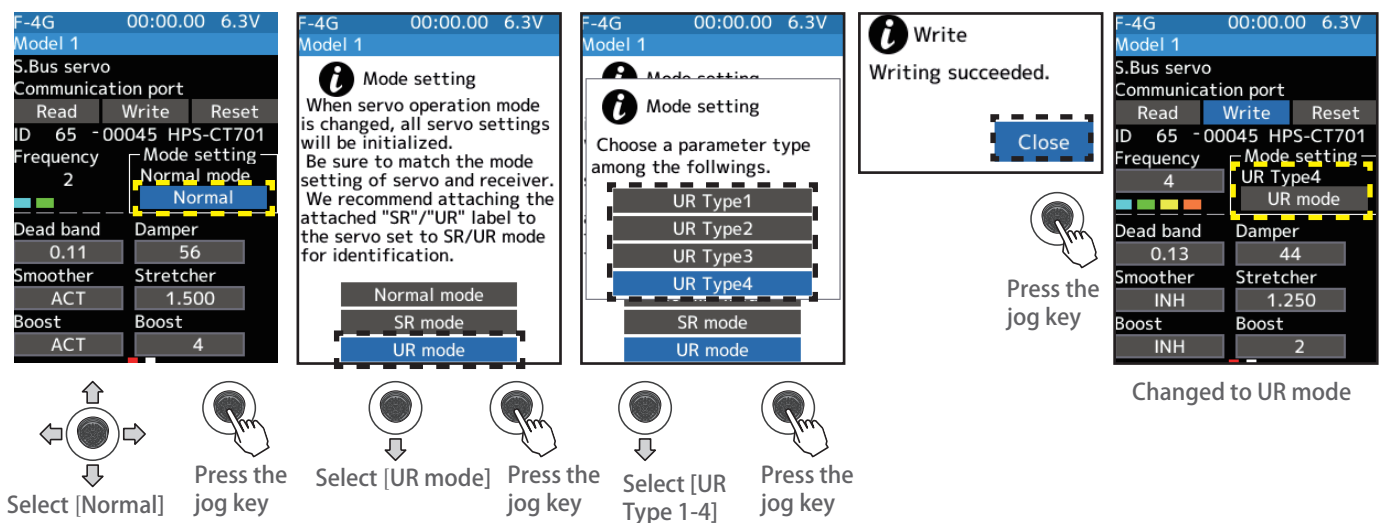

5 Remove the UR servo from the transmitter. It can be used as a servo in UR mode.

UR TIP
•Servo parameter setting "Frequency"
 Hunting occurs when the servo frequency is set high, but this is not a malfunction. Use by lowering the frequency value.

UR mode



S.BUS function setup

- 1 Select [value] with the jog key, and set the value with the [+] or [-] button when it is displayed in blue. In the case of multiple selection (if the item does not have a frame), select the item with the jog key and a pop-up screen will appear, so select it with the jog key and press it.

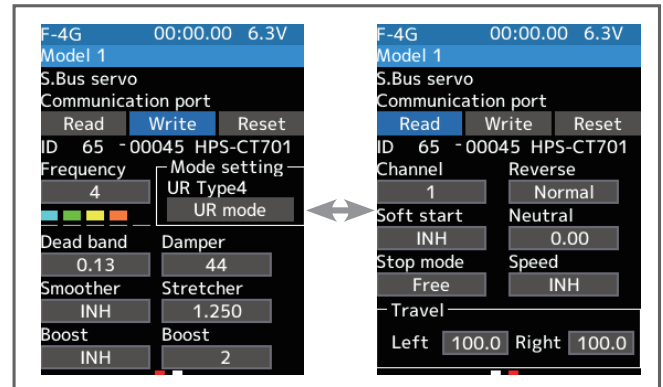

ID

Displays the ID of the servo where parameters are to be read. It cannot be changed.

Dead band

The dead band angle at stopping can be specified.

[Relationship between dead band set value and servo operation]

Small - Dead band angle is small and a small signal change immediately operates the servo.

Large - Dead band angle is large, and the servo does not operate at small signal changes.

(Note) If the dead band angle is too small, the servo will work continuously, and the current consumption will increase, and the life of the servo will be shortened.

Damper

The characteristic when the servo is stopped can be set.

When smaller than the standard value, the characteristic becomes an overshoot characteristic. If the value is larger than the standard value, the brake is applied before the stop position.

Especially when a large load is applied, overshoot, etc. are suppressed by inertia and hunting may occur, depending on the conditions. If hunting (phenomena which causes the servo to oscillate) occurs even though the Dead Band, Stretcher, Boost, and other parameters are suitable, adjust this parameter to a value larger than the initial value.

[Relationship between damper set value and servo operation]

Small - When you want to overshoot. Fixed so that hunting does not occur.

Large - When you want to operate so that braking is not applied. However, it will feel like the servo response has worsened.

(Note) If used in the hunting state, not only will the current consumption increase, but the life of the servo will also be shortened.

Smoother

This function makes the servo operation smooth. Set it according to your taste. Normally set it to "ACT". Set it to "INH" when you want an exceptionally quick operation. When the smoother function was set to "ACT" and the servo has operated the distance up to the target position is changed in steps so movement is smooth.

Stretcher

The servo hold characteristic can be set. The torque which attempts to return the servo to the target position when the current servo position has deviated from the target position can be adjusted.

This is used when stopping hunting, etc., but the holding characteristic changes as shown below.

[Relationship between stretcher and servo operation]

Small - Servo holding force becomes weaker.

Large - Servo holding force becomes stronger.

(Note) When this parameter is large, the current consumption increases.

Boost/Boost (ON/OFF)

INH: Boost is ON at the time of low-speed operation. (Normal)

ACT: Boost is always ON. (For quick operation).

The minimum current applied to the internal motor when starting the servo can be set. Since a small travel does not start the motor, it essentially feels like the dead band was expanded. The motor can be immediately started by adjusting the minimum current, which can start the motor.

[Relationship between boost set value and servo operation]

Small - Motor reacts to a minute current, and operation becomes smooth.

Large - Initial response improves and output torque increases. However, if the torque is too large, the operation will become rough.

Channel

This is the S.BUS system channel assigned to the servo. When connected to the receiver S.BUS2 connector as an S.BUS system, the channel used by the transmitter is assigned. When the normal receiver channel is used, the channel setting is unnecessary.

Reverse

The direction in which the servo rotates can be changed.

Soft Start

Restricts operation in the specified direction the instant the power is turned on. By using this setting, the first initial movement when the power is turned on slowly moves the servo to the specified position.

Neutral

The neutral position can be changed. When the neutral offset is a large value, the servo's range of travel is restricted on one side.

Stop Mode

The state of the servo when the servo input signal is lost can be specified. The "Hold" mode setting holds the servo in its last commanded position even if using AM or FM system.

Speed

Speeds can be matched by specifying the operating speed. The speed of multiple servos can be matched without being affected by motor fluctuations. This is effective for load torques below the maximum torque.

However, note that the maximum speed will not exceed what the servo is capable of even if the servos operating voltage is increased.

Travel [Left]/[Right]

The maximum left and right travel centered about the neutral position can be set independently.



MC (ESC) Link

This function allows you to change the data of Futaba MC971CR and Acuvance Xarvis on the T6PV unit.

This function is used by connecting ESC directly to the transmitter.

Use the various optional servo extension cords according to the distance between the transmitter and ESC.

-In the wireless setting, reading / writing / reset / initialization may take a long time or may fail depending on the surrounding radio wave environment. If it fails, try again.

MC/Acuvance Settings (Acuvance Xarvis)

The MC971CR/Acuvance Xarvis can be used in both wired and wireless (F-4G/T-FHSS) modes that can be set while connected to a receiver. In addition, the telemetry system can display data such as motor RPM and ESC body temperature on the transmitter (F-4G/T-FHSS system only).

- The wireless method requires a receiver that supports the wireless setting function.
- Futaba MC971CR is a product developed in collaboration with Acuvance Co., Ltd.
- Acuvance Xarvis is a product of Acuvance Co., Ltd.

Connecting the transmitter and ESC

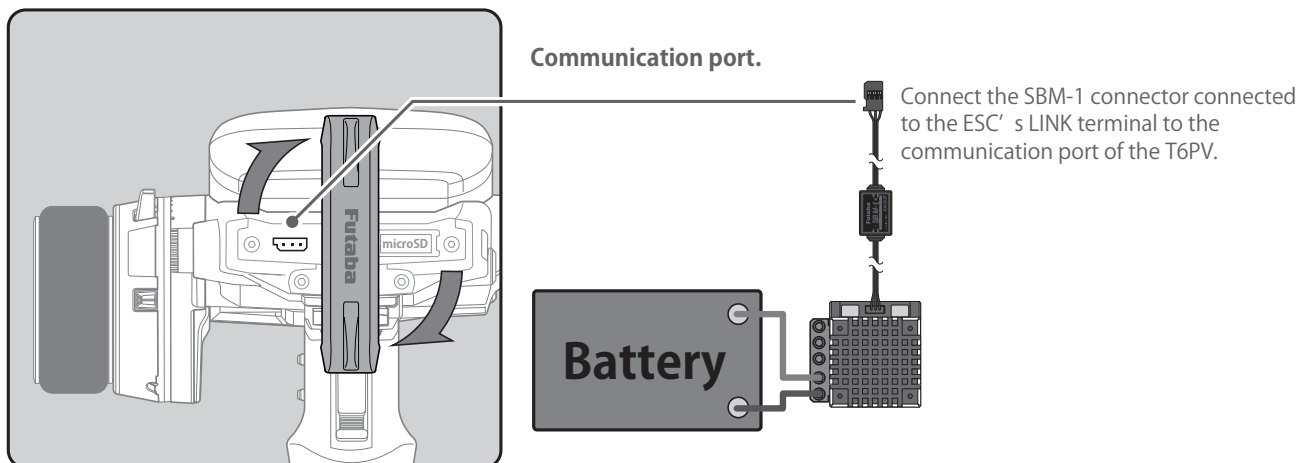

Wireless Connectivity

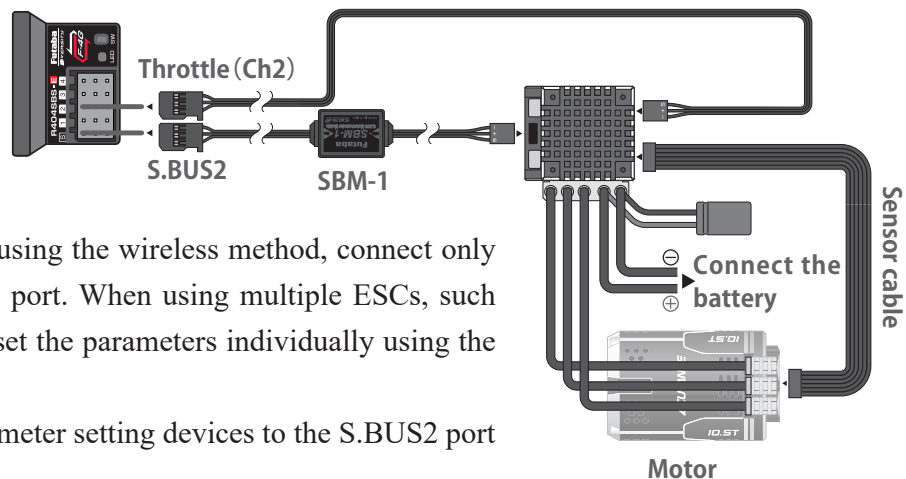

- When setting parameters using the wireless method, connect only one ESC to the S.BUS2 port. When using multiple ESCs, such as in a dual ESC setup, set the parameters individually using the wired method.
- Do not connect other parameter setting devices to the S.BUS2 port at the same time.
- Connect a battery to the ESC as well.
- Be sure to connect the sensor cable.



ACCESSORY MENU

- Connect the battery to the ESC.

The MC (ESC) Link screen can be displayed in the following way.

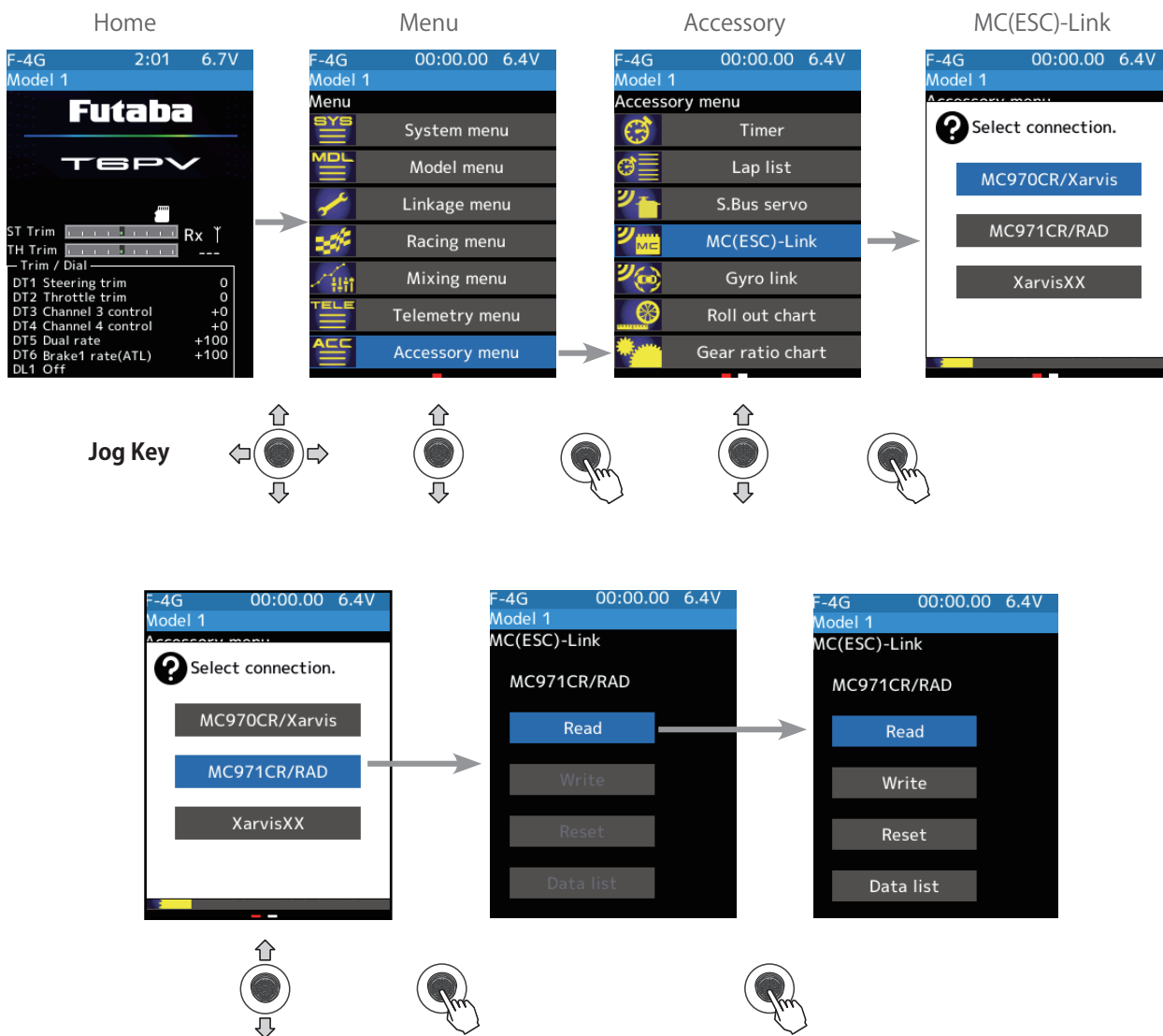

It is compatible with Acuvance Xarvis/
XarvisXX. For details on the functions,
please contact Acuvance Corporation.

How to use MC (ESC) Link

(Preparation)

- Connect the ESC according to the connection diagram.
- Turn on the transmitter's power switch PWR and display the MC (ESC) link screen. (This can also be done on the DSP side in the case of a wired system.)
- Connect the battery to the ESC and turn on the ESC power switch.
- Set the ECS to [MC link mode]. (See the ESC instruction manual)

1 (Read ESC)

Execute this to read the data currently set in the ESC. Select **[Read]** with the Jog key and press it. A screen for selecting the connection method will be displayed, so select **"Communication Port"** for a wired method, or **"Wireless (Rx S.BUS2)"** for a wireless method with the Jog key and press it.

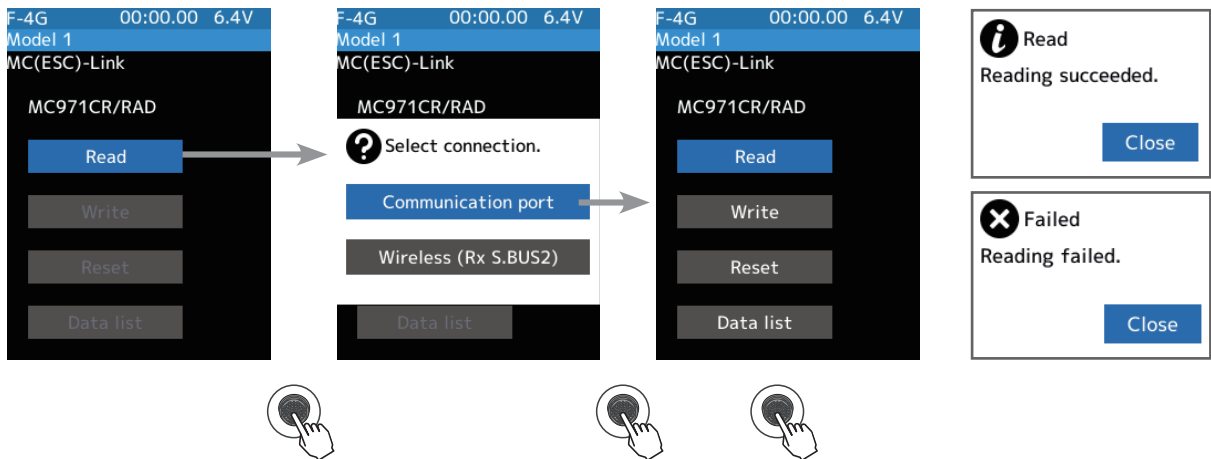

- "Reading succeeded" will be displayed on the screen, and the ESC type and current settings will be loaded. If "Reading failed" is displayed, communication with the ESC is not working properly. Check the connection between the T6PV and the ESC, the battery connection to the ESC, and the power switch of the ESC, then perform the "Load" operation again.

Note :

When selecting "Wireless (Receiver S.BUS2)", release your fingers completely from the throttle trigger or stick at the neutral point of the ESC and make sure the standby LED (red) is lit. If you are even slightly off the neutral point, the data will not be read correctly.

2 (Writing to ESC)

To write setting data to the ESC, after entering the ESC settings, select **[Write]** with the Jog Key and press it.

- The screen will display "Writing succeeded" and the setting data will be written to the ESC. If the screen displays "Writing failed", communication with the ESC is not working properly. Check the connection between the T6PV and the ESC, the battery connection to the ESC, and the power switch of the ESC, then perform the [Write] operation again.

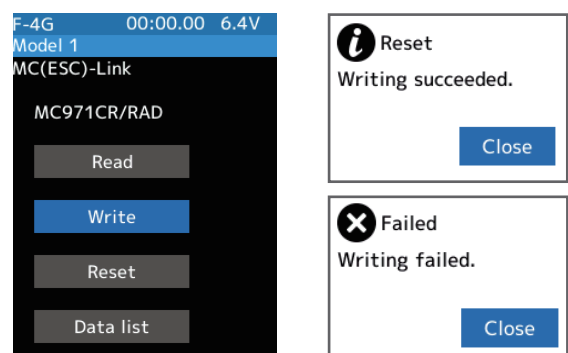

3 (Reset/Initialization)

Write the initial setting data to the connected ESC. Select the setting item **[Reset]** with the Jog Key and press it.

- The screen will display “Writing succeeded” and the setting data will be written to the ESC. If the screen displays “Writing failed”, communication with the ESC is not working properly. Check the connection between the T6PV and the ESC, the battery connection to the ESC, and the power switch of the ESC, then perform the [Write] operation again.

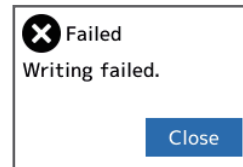
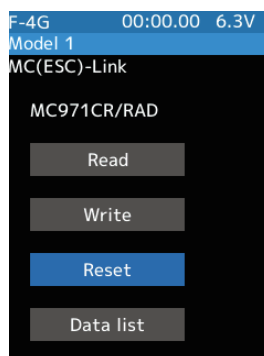

Data list

1 Use the Jog Key to select the setting item **[Data List]** and press it to display the loaded ESC data.

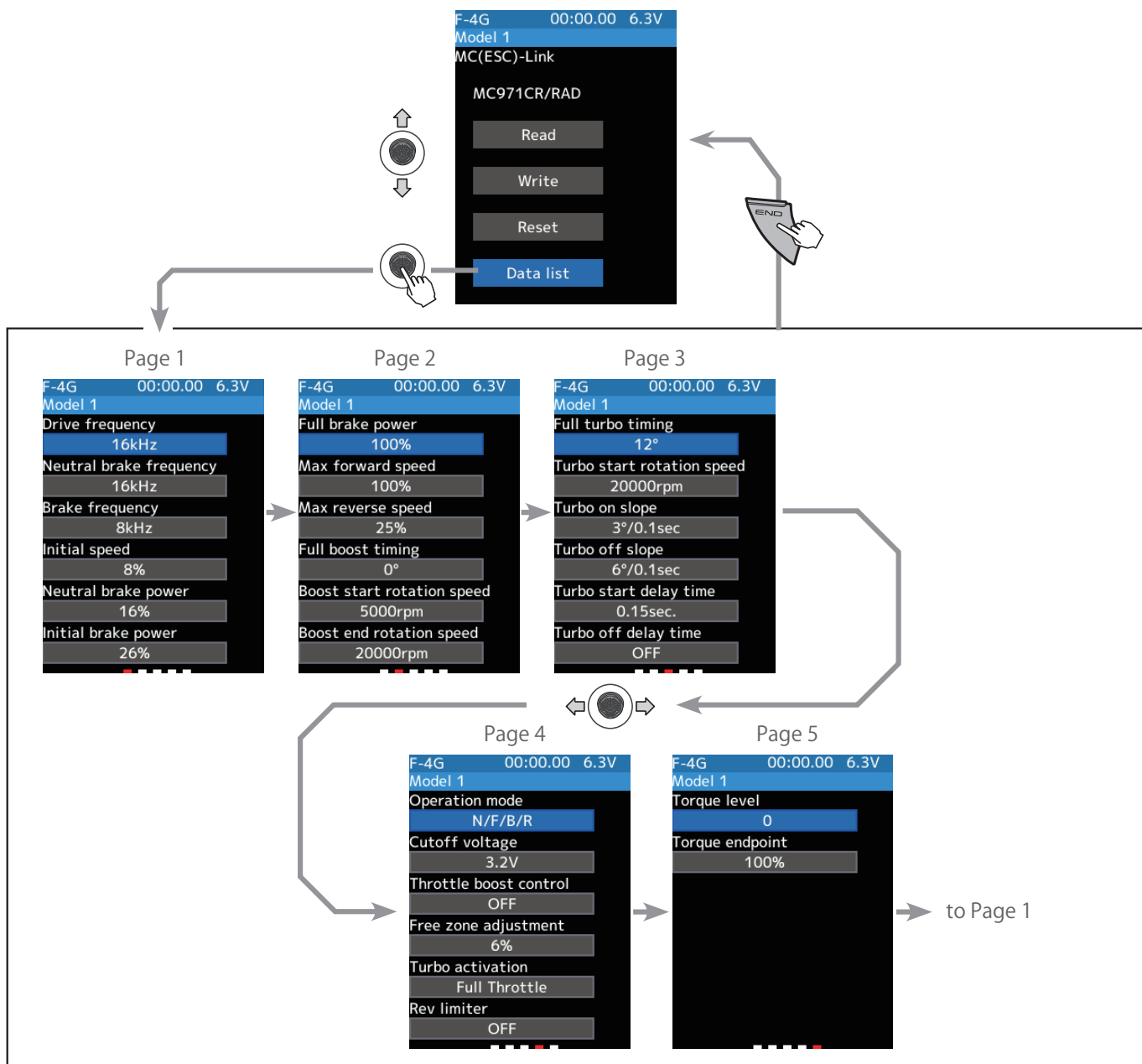

Setting each data

1 Use the Jog Key to select each value in the **[Data list]**, and when the value is displayed in blue, press the **+ or - button** to set it.

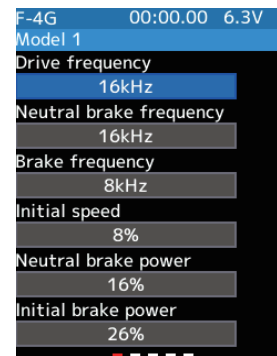

* Drive frequency (kHz)

- 1 ~ 16kHz(1kHz Step) & 16 ~ 32kHz(2kHz Step) & 35 • 38 • 42 • 55 • 64kHz
Adjust Acceleration.
Lower Number (Acceleration : increase / Smoothness : Decrease)
Higher Number (Acceleration : Decrease / Smoothness : Increase)

* Neutral brake frequency (kHz)

- 0.5kHz (500Hz), 1kHz (1000Hz) ~ 32kHz (32000Hz) (1-16=1kHz step, 16-32kHz=2kHz step)
Select the motor neutral brake smoothness when the transmitter throttle is at neutral.
Lower Number (Braking : increase / Smoothness : Decrease)
Higher Number (Braking : Decrease / Smoothness : Increase)

* Brake frequency (kHz)

- 0.5kHz (500Hz), 1kHz (1000Hz) ~ 32kHz (32000Hz) (1-16=1kHz step, 16-32kHz=2kHz step)
Select the brake smoothness when applying the brake.
Lower Number (Braking : Increase / Smoothness : Decrease)
Higher Number (Braking : Decrease / Smoothness : Increase)

* Initial speed (%)

- 0 ~ 50% (2% step)
Select the initial speed when accelerating from a stop. Higher number : More sudden start. Because you add load to the motor and drive system, please be careful of overheating issues. Gear your vehicle appropriately.

* Neutral brake power (%)

- 0 ~ 100% (2% step)
Select the motor neutral brake initial power when the transmitter throttle is at neutral.
Lower Number : Soft Breaking, Higher Number : Strong Breaking.

* Initial brake power (%)

- 0 ~ 50% (2% step)
Select the initial brakes power when the brake is applied.
Lower Number : Soft Breaking, Higher Number : Strong Breaking.

* Full brake power (%)

- 0 ~ 100% (2% step)

Select the maximum brake power when applying full brakes during a run.

Lower Number : Soft Breaking, Higher Number : Strong Breaking.

* Max forward speed (%)

- 50 ~ 100% (2% step)

Function that limit the maximum speed at full throttle.

* Max reverse speed (%)

- 25 ~ 100% (25% step)

Function that limit the maximum speed while reversing.

* Full boost timing (deg.)

- 0 ~ 60deg. (1deg. step)

It is the normal timing effective throughout your throttle range. It affects the motor speed.

*If the motor itself can set a mechanical lead angle, the mechanical lead angle will be added to 60 deg. Since this will place a large load on each device, please be careful with the motor's mechanical lead angle value.

* Boost start rotation speed (rpm)

- 1,000 ~ 40,000rpm (500rpm step)

It is the RPM value at which the Boost starts. The throttle stays linear until this RPM is reached.

* Boost end rotation speed (rpm)

- 10,000 ~ 100,000rpm (500rpm step)

It is the RPM value at which the Boost reaches the “full boost digital timing”. Beyond this RPM value, the throttle turns linear again.

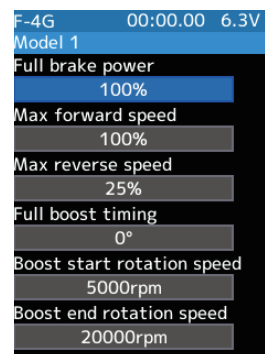

Boost start rotation speed / Boost end rotation speed

The Boost Start RPM value and Boost End RPM value should be given enough space for the timing to ramp up smoothly.

CAUTION!! When using this function for the first time, start with a setting that keep enough interval between both RPM, and narrow it accordingly to your liking until satisfied.

IMPORTANT!! Always set the boost end RPM higher than the boost start RPM.

* Full turbo timing (deg.)

- 0 ~ 60deg. (1deg. step)

It is the additional timing added to the Boost timing.

* Turbo start rotation speed (rpm)

- 10,000 ~ 50,000rpm (500rpm step)

It is the motor RPM value at which the turbo function starts.

This item is effective only when the Turbo Activation is set in “RPM “ or “Full Throttle & RPM”

* Turbo on slope (deg./0.1sec.)

- 1 ~ 50deg./0.1sec. (1deg./0.1sec. step)

It refers to the Turbo Timing increasing rate. The higher it is, the faster the Turbo Timing increases, resulting in faster acceleration.

This feature is very sensitive and changes drastically with only a 0.1deg change. Adjust this setting slowly until reaching the desired result.

* Turbo off slope (deg./0.1sec.)

- 1 ~ 50deg./0.1sec. (1deg./0.1sec. step)

It refers to the Turbo Timing decreasing rate. The higher it is, the faster the Turbo Timing decreases, slowing down turbo effects until it reaches the maximum timing value.

* Turbo start delay time (sec.)

- OFF(0) ~ 1.00sec. (0.05sec. step)

The time it takes for the turbo to start after the Full Throttle or Turbo RPM value is reached. (ex: if value is 0.50, it will take 0.5sec for the turbo to start.)

This item is effective only when the Turbo Activation is set in “RPM “ or “Full Throttle & RPM”

* Turbo off delay time (sec.)

- OFF(0) ~ 1.00sec. (0.05sec. step)

The time it takes for the turbo to turn off after the full throttle is released. (ex: if value is 0.50, it will take 0.5sec for the turbo to stop)

This item is effective only when the Turbo Activation is set in “RPM “ or “Full Throttle & RPM”.

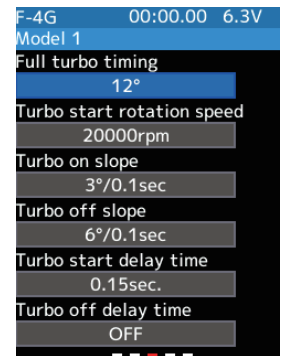

* Operation mode

1. N/F/B Normal/Forward/Brake
2. N/F/B/R Normal/Forward/Brake/Reverse
3. N/F/R Normal/Forward/Reverse
4. R/F/B Reverse/Forward/Brake
5. R/F/B/R Reverse/Forward/Brake/Reverse
6. R/F/R Reverse/Forward/Reverse

There are six operation modes.

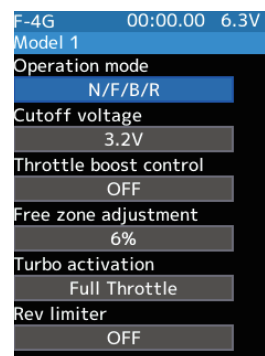

* Cutoff voltage (V)

- NONE, 2.6 ~ 3.6V/cell (0.1V/cell step)

When the battery voltage drops to the set value, the vehicle will slow down to notify the driver that the battery voltage is low, and prevent the receiver from going into a no-control state. If you are using a battery that is sensitive to over-discharge, you can prevent battery damage by setting the voltage higher than the battery damage voltage (varies depending on the battery).

* Throttle boost control

- ON / OFF

This is a safety function that automatically controls the RPMs to prevent sudden changes even if the throttle is operated suddenly when using the boost function.

* Free zone adjustment (%)

- 1 ~ 6% (1% step)

This is a safety function that automatically controls the RPMs to prevent sudden changes even if the throttle is operated suddenly when using the boost function.

* Turbo activation

- Full Throttle & RPM • RPM • Full Throttle

Determines what triggers the turbo to activate.

[Full Throttle] • • The turbo kicks in when the throttle is at full throttle.

[RPM] • • The turbo will start working when the motor speed reaches the “turbo start speed” .

[Full Throttle & RPM] • • The turbo will activate when either full throttle or the turbo start RPM is reached, whichever comes first.

* Rev limiter (rpm)

- OFF, 10,000-100,000rpm (1,000rpm step)

This function sets the upper limit of the motor rotation speed.

Unlike the “Maximum Speed Limit” which limits the output according to the throttle position, this limits the output according to the motor RPMs. This can prevent unexpected speed increases when using a high speed motor.



ACCESSORY MENU

* Torque level

- -5 ~ 0 ~ +5

A setting of 0 is the normal state. The higher the value, the more torque-like acceleration and gentler deceleration will be achieved, and the lower the value, the more gentle the acceleration and suddener the deceleration will be.

* Torque end point

- 20 ~ 100% (5% step)

Set the throttle range where the torque level function operates (0% to the set value). After the torque end point, the normal output characteristics will be obtained.

* BEC voltage

- 6V or 7.4V

BEC voltage setting. Adjusts the voltage supplied to the receiver.

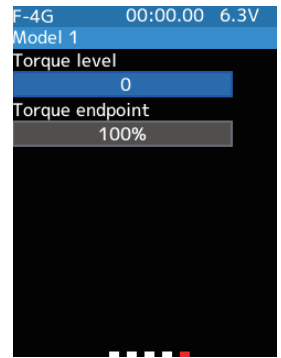

MC/Acuance (Telemetry sensor registration)

MC/Acuance can display the following data via telemetry, and the RPM can also be displayed on the MC Link parameter setting screen.

- Rotational speed ● Internal ESC temperature ● Motor temperature * ● Battery voltage

*The motors that support the motor temperature measurement function are the "LUXON AGILE" series manufactured by Accuance Co., Ltd. If any other motor is connected, motor temperature measurement is not guaranteed.

- To display telemetry, set the ESC to [MC Link Mode]. It cannot be displayed in [ESC Mode].

- MC/Acuance uses seven consecutive slots. The default start slot is 1. The slot numbers that can be assigned to the start slot are 1, 8, 9, 16, 17, 24, and 25.

How to assign MC/Acuance in the sensor list

1 Displays the sensor list screen of the telemetry menu.

2 Set the start slot.

On the **[Sensor select]** screen, select [-----] with the jog key and press it to remove it from the sensor list. Delete **[RPM sensor]** and **[Voltage sensor]** from the sensor list.

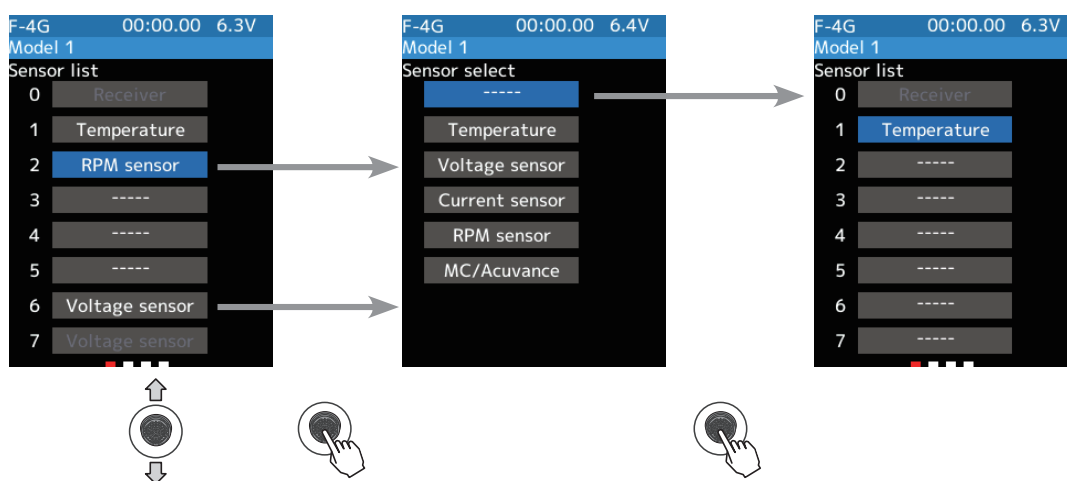

3 Select and press slot 1 **[Temperature Sensor]** in the sensor list with the Jog Key, and select **[MC/Acuance]** displayed on the sensor selection screen. **[MC/Acuance]** will be displayed in slot 1 on the telemetry screen.

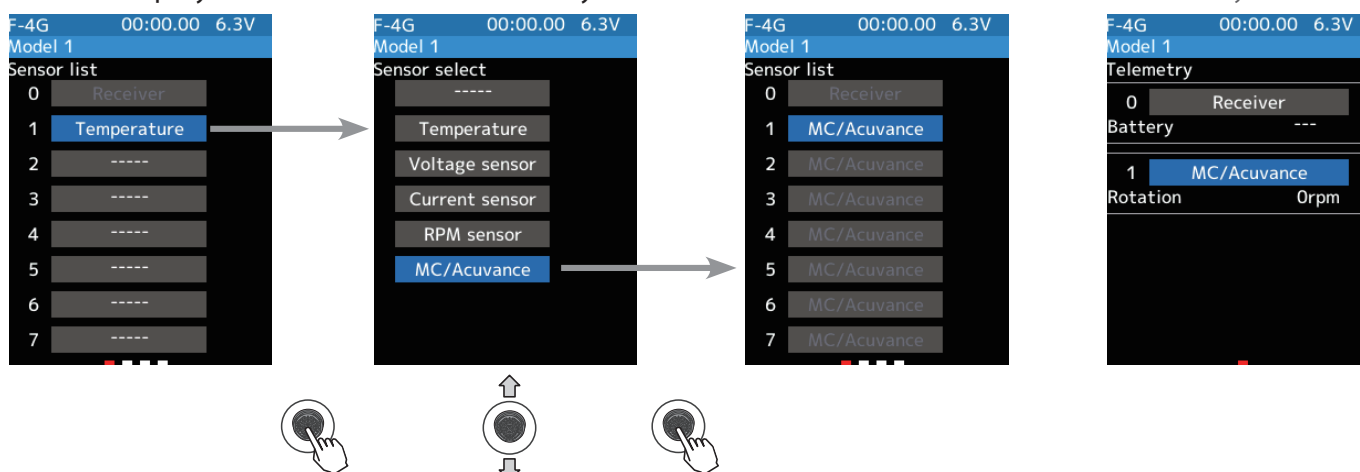

Using the sensor registration function (to automatically register in an empty slot on the transmitter)

- 1 Connect only the **SBM-1** to the communication port of the transmitter.
- 2 Display the **Telemetry menu** → **Sensor menu** screen. On the Sensor menu screen, select **[Sensor Registration]**. The ESC slot number will be automatically set and **[MC/Acuance]** will be displayed on the Telemetry screen.

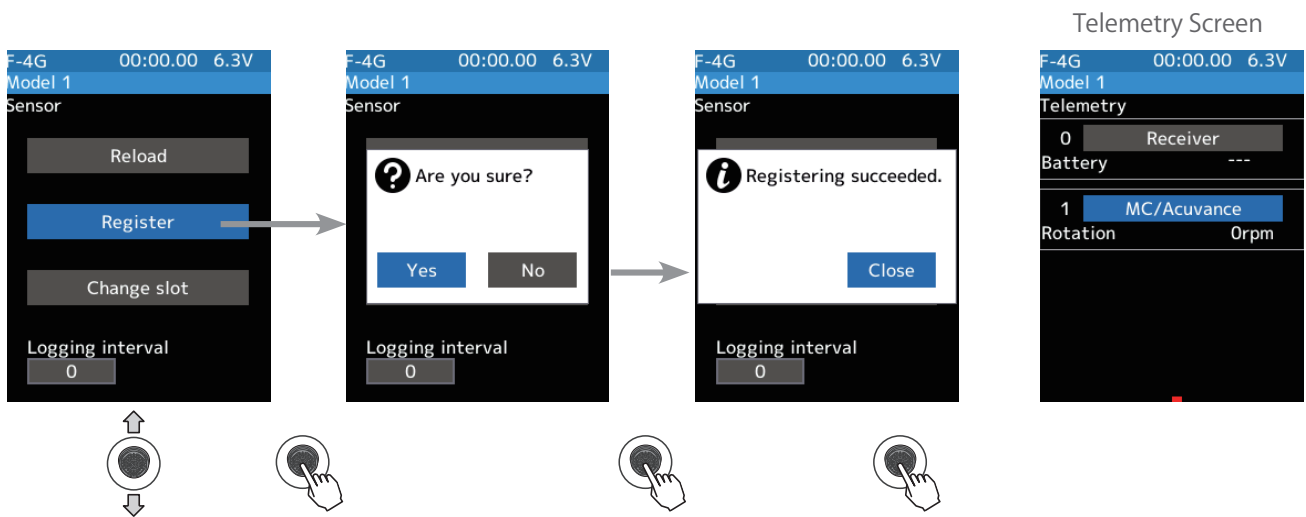

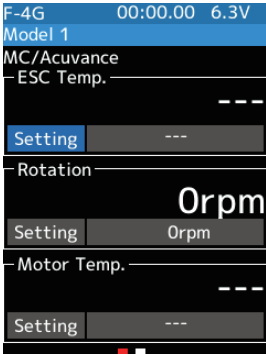

Once the ESC is registered as a telemetry sensor, you can set limits and alarms in the same way as other temperature sensors, RPM sensors, etc.

You can also change the slot number in the same way as other telemetry sensors.



Gyro link

The Gyro Link is a function that allows you to set the parameters of the car gyro wirelessly from the transmitter.

* A gyro compatible with the wireless setting: GYD550 (As of Jan. 2025)

- Up to five presets can be switched while driving. (Gyro data switching function)
- The S.BUS servo data can be set wirelessly from the transmitter via the gyro.

* A receiver compatible with the wireless setting function is required. (As of Jan. 2025, R404SBS/ R404SBS-E/R334SBS-ver. 4.0 or later / R334SBS-E-ver. 4.0 or later)

* While using Gyro Link wireless SBUS servo adjustment will not function.

- To be able to control gyro gain, etc. from the transmitter, it is necessary to enable the gyro mixing function of the transmitter.
- In the wireless setting, reading / writing / reset / initialization may take a long time or may fail depending on the surrounding radio wave environment. If it fails, try again.

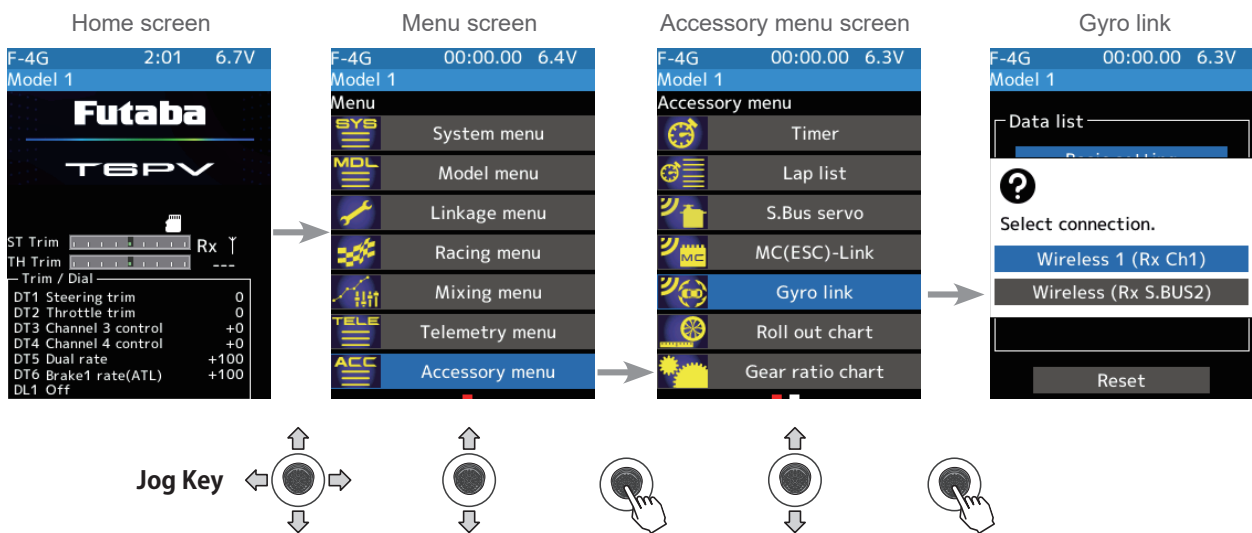

Using the Gyro Link function

(Preparation)

- Connect the receiver and gyro according to the connection diagram below.

* The connection diagram is a reference diagram for selecting the gyro link connection method. Please read the gyro instructions for details or cautions.

- Turn on the power switch PWR of the transmitter to display the Gyro Link screen.

* Note that this cannot be used with the display switch DSP.

- Turn on the receiver power switch.

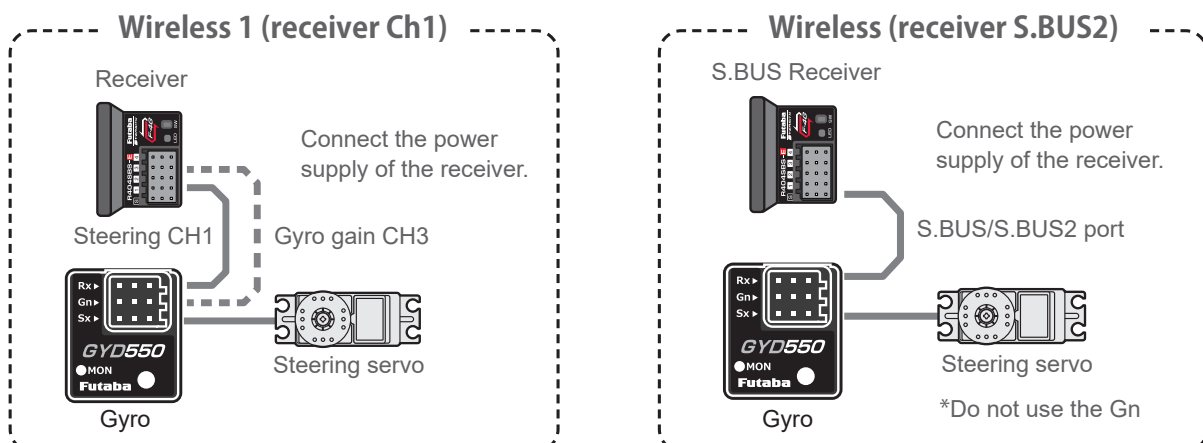

1 (Gyro read)

When you open the Gyro Link screen from the Accessory menu, the connection method selection screen is displayed. Press jog key the button according to the connection method between the gyro and the receiver.

The Gyro type and currently set contents are read.

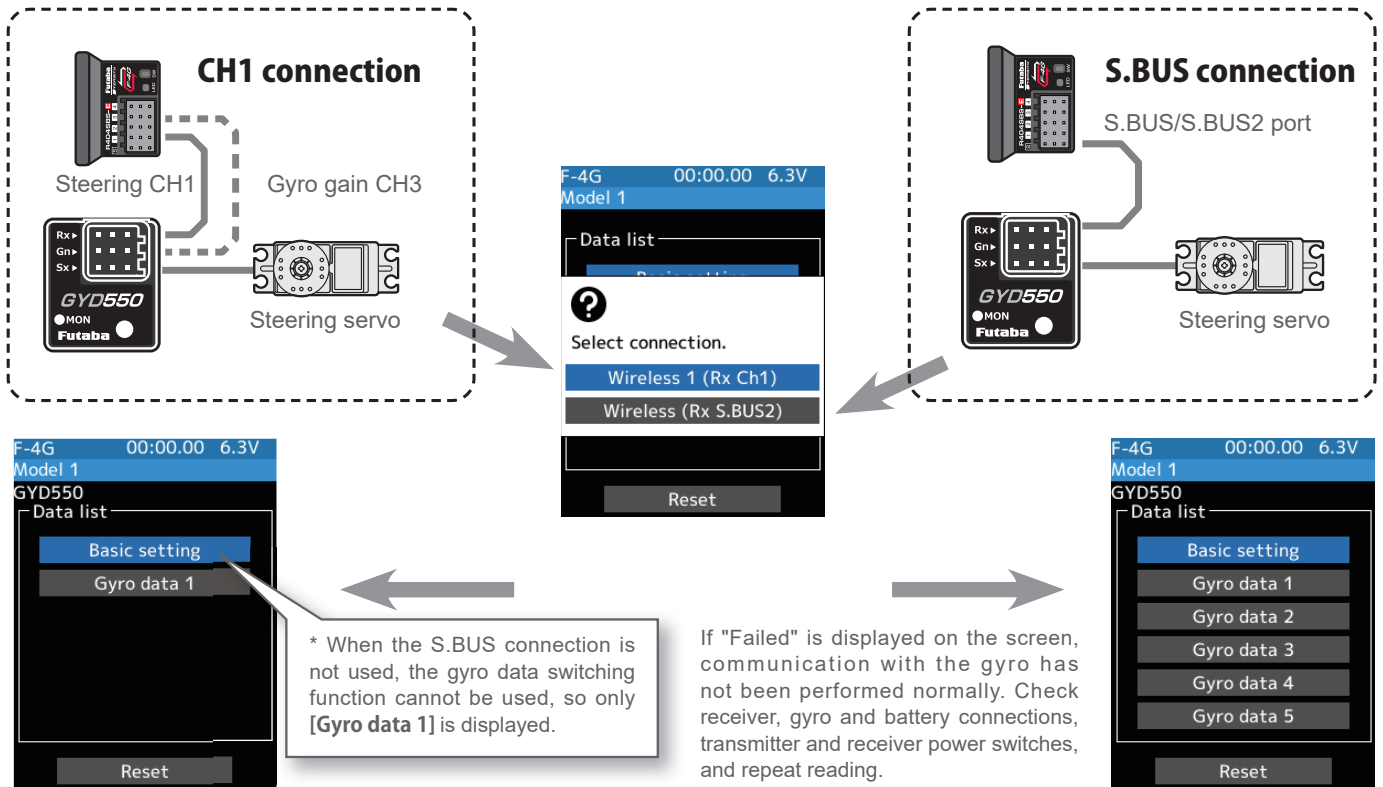

2 (Writing to Gyro)

Execute this function to write the setting data to the Gyro.

Press jog key the setting item [Write] on both the Basic setting screen and the Gyro data screen. After "Read Please wait" is displayed, an electronic sounds and writing ends. Be sure to write after changing the settings.

- If "Failed" is displayed on the screen, communication with the gyro has not been performed normally. Check receiver, gyro and battery connections, transmitter and receiver power switches, and repeat [Write].
- Refer to "Setting method of each item" for the contents of the setting data.

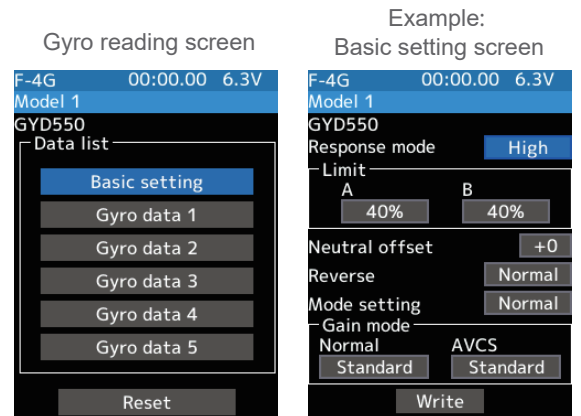

3 (Initialization)

Write the factory set Gyro setting data to the connected the Gyro. Select the [Reset] on the gyro reading screen; the confirmation screen will be displayed. To execute, Select the [Yes] to hear an electronic sound and finish setting. To cancel, select [No] and press jog key it.

- If "Failed" is displayed on the screen, communication with the gyro has not been performed normally. Check receiver, gyro and battery connections, transmitter and receiver power switches, and repeat [Reset].

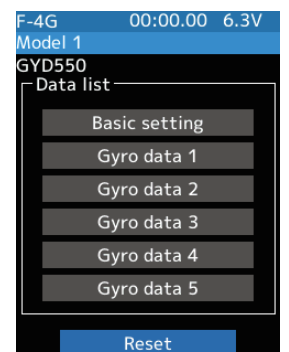

Display data list

The gyro setting data is divided into the Basic setting and Gyro data (1 to 5) screens and displayed by the method shown on the right.

- When the S.BUS connection is not used, the gyro data switching function cannot be used, so only [Gyro data 1] is displayed.

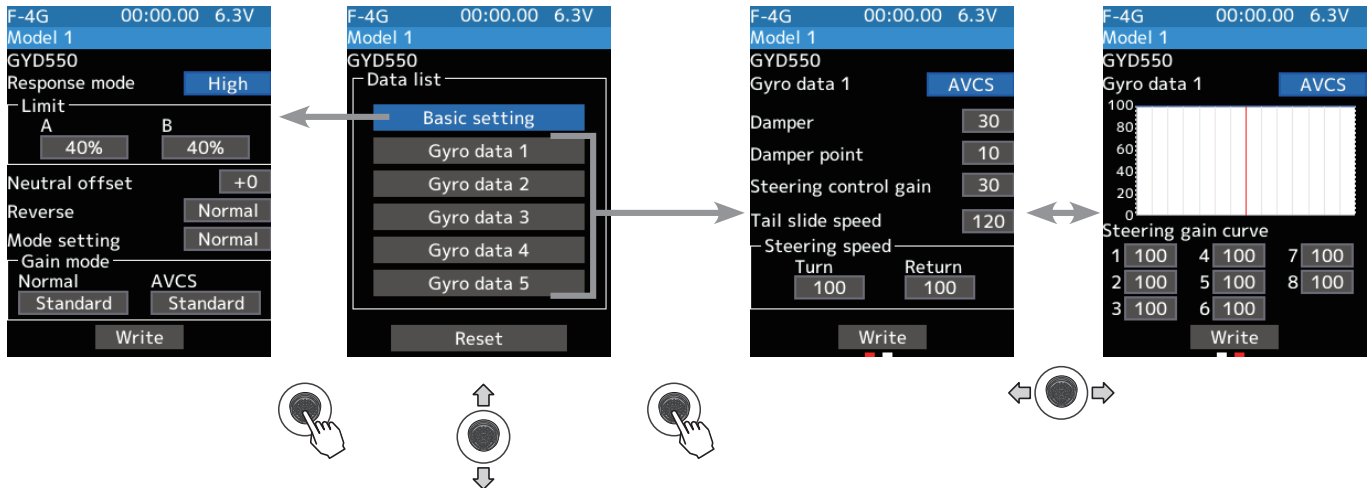

Data settings

Select [Value] with the jog key and press, the setting value will be displayed in blue, use the [+] or [-] button to set the value. In the case of selection type, select the item to switch the data. Be sure to click [Write] after changing the settings. Otherwise the gyro settings will not change.

Response mode

Gyro sensor response setting.

- * Low → Middle → High speeds up response.
- * In high mode, using the dead band angle is too small, the servo will work continuously, but there is no problem in running. However, if strong the servo will work continuously occurs, set to middle or low mode.

Limit

Adjustment function of maximum steering angle.

- * Operate the steering and adjust the left and right separately so that the maximum steering angle is obtained as long as the tires do not interfere with the arms.
- * If the adjustment value of the limit is small (the maximum steering angle is not adjusted), it becomes easier to spin.
- * During limit adjustment, the steering angle is amplified by 1.5 times, but this is not a malfunction. However, perform drive after completing the limit adjustment.

SR mode setting

Set to SR mode.

- * Set the SR compatible servo to SR only when using SR mode.

Neutral offset

Neutral adjustment function of the steering servo.

- * Do not use transmitter trim and sub trim. Make the neutral setting with a gyro.

Reverse

Gyro control direction setting.

- * If the car is turned to the left by hand steering goes out on the right.

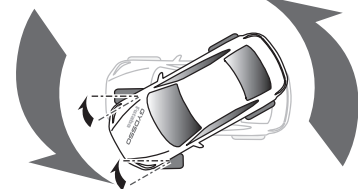

Gain mode

Gyro internal control gain switching.

- * High gain is 1.5 times more sensitive than standard gain.
- * Normally set to standard. Set to high gain if increasing the sensitivity setting of the transmitter to the maximum value is not enough.

Gyro data 1/2 2/2

The gyro data setting screen has two pages, use the jog key left and right to turn the pages. Also, data can be set independently in each gyro operation mode (NORMAL / AVCS).

AVCS and normal mode change button

The AVCS / NORMAL modes setting.

The gyro has 2 operating modes: NORMAL mode and AVCS mode.

In the AVCS mode, gyro control is firmer.

- * The feel of operation is different, choose your favorite mode.
- * NORMAL: The driver needs to perform counter-steer → Operation opposite to the turn direction.
- * AVCS: The gyro performs countersteer → Steer in the turn direction.

Damper

Hunting suppression

The higher the value, the stronger the hunting suppression. However, it will feel like the servo response has worsened.

Steering control gain

Adjustment of intervention ratio of steering operation to gyro control.

When the numerical value is increased, the steering operation of the driver is largely reflected.
* The steering response feels fast.

Steering speed

The function to adjust servo speed for steering operation (same the function as servo speed of the transmitter).

* The smaller the value, the slower the servo speed.

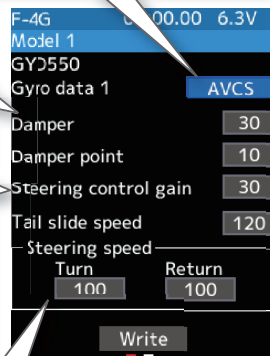

Gyro data screen 1/2

Damper point

Adjust the servo response due to the effect of the damper against the gyro effect.

- * The smaller the value, the stronger the influence of the Damper and the slower the servo speed.
- * The higher the value, the slower the Damper will operate and the better the response, but the more likely it is that hunting will occur.

Tail slide speed

Adjust the speed of the tail slide (shake the tail) when driving.

- * Decreasing the numerical value decreases the speed of the tail slide, and increasing the numerical value increases the speed.
- * Effective for adjusting the tail slide amount during steering operation.

Steering gain curve

Eight points of gain can be set up to the endpoint based on neutral.

* It is set in conjunction with left-right symmetry.

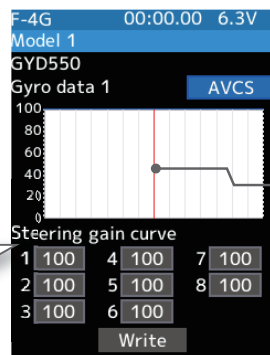

Gyro data screen 2/2

* The vertical cursor line moves in conjunction with the operation of the steering.

Gyro data switching function

Gyro data can be switched with the push switch or trim lever/dial of the transmitter. (Up to 5 gyro data)

- Connect the gyro to the S.BUS2 terminal of the receiver.
- The gyro mixing function must be enabled.

When switching with the push switch

- 1 On the Gyro mixing screen, set the function to ON.
- 2 The Channel select screen will appear. Select a channel with the jog key and press it.
- 3 **[Linkage Menu]** → **[Switch Select]** setting screen and select the switch you want to use to switch data.
- 4 On the function selection screen, assign the gyro data to be used from **[Gyro data 1]** to **[Gyro data 5]**.

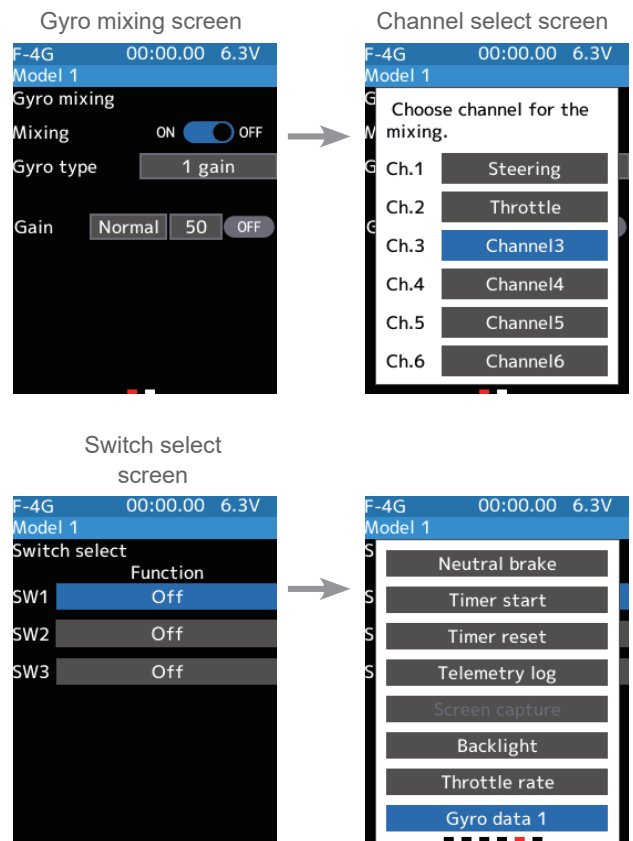

When switching with the Trim/Dial

- 1 On the Gyro mixing screen, set the function to ON.
- 2 The Channel select screen will appear. Select a channel with the jog key and press it.
- 3 **[Linkage Menu]** → **[Trim/Dial Select]** setting screen and select the Trim/Dial you want to use to switch data.
- 4 On the function selection screen, select **[Gyro Data]** with the jog key and press it.

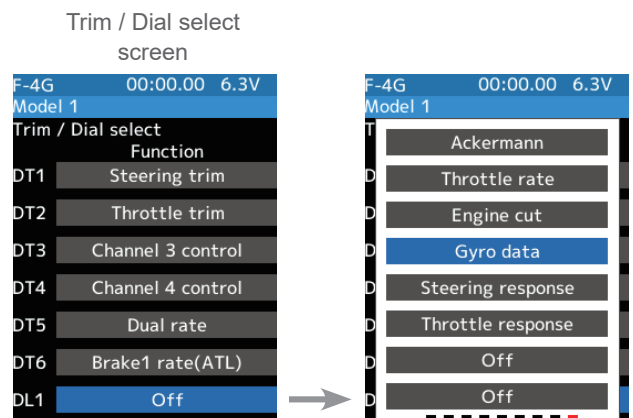



Roll out chart

This function is designed for pan cars. The roll out chart can be calculated from input values for the number of teeth of the spur gear and pinion gear, and the tire diameter, and displayed as a table.

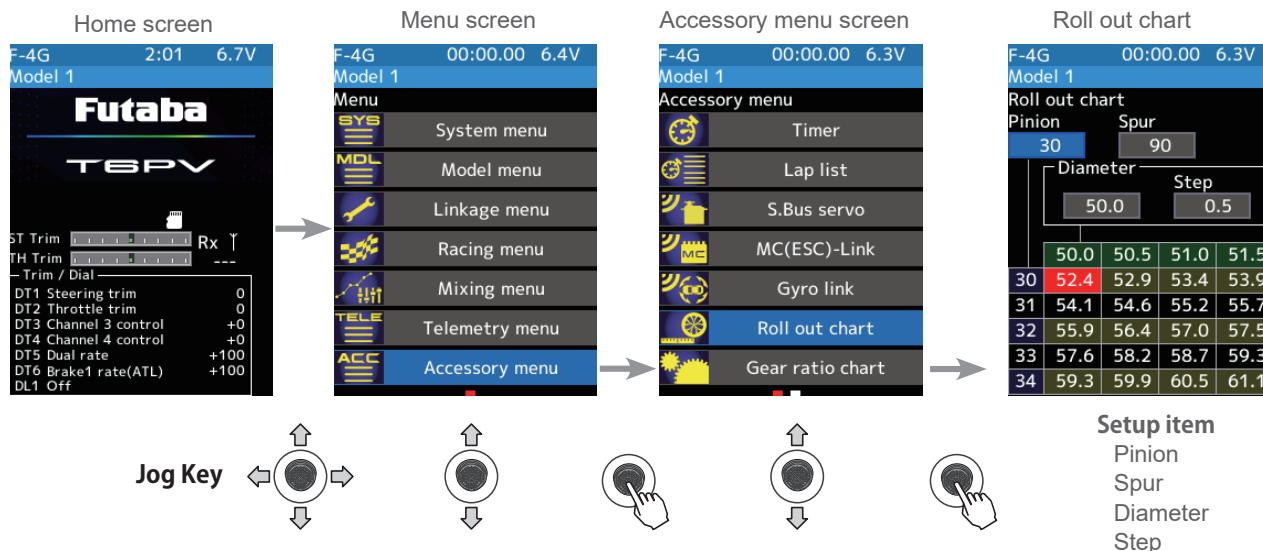

Use of Roll out chart function

1 (Setting of a step of the tire diameter input)

Use the jog key to move the cursor to the [Step] value. Use the [+] or [-] button to set the Step of the numerical input value of the tire diameter amount.

- The step amount can be set in the range of 0.1-mm to 1.0-mm.

F-4G 00:00.00 6.3V
Model 1
Roll out chart
Pinion 30 Spur 90
Diameter 50.0 Step 0.5
50.0 50.5 51.0 51.5
30 52.4 52.9 53.4 53.9
31 54.1 54.6 55.2 55.7
32 55.9 56.4 57.0 57.5
33 57.6 58.2 58.7 59.3
34 59.3 59.9 60.5 61.1

Adjustment buttons

- Adjust with the [+] or [-] button.
- Return to the initial value by press the [+] and [-] button simultaneously

2 (Setting of number of teeth of spur gear)

Use the jog key to move the cursor to the [Spur] value. Use the [+] or [-] button to set the spur gear. The roll out is then calculated, and the list is updated.

3 (Setting of number of teeth of pinion gear)

Use the jog key to move the cursor to the [Pinion] value. Use the [+] or [-] button to set the pinion gear. The roll out is then calculated, and the list is updated.

4 (Setting of tire diameter)

Use the jog key to move the cursor to the [Diameter] value. Use the [+] or [-] button to set the tire diameter. The roll out is then calculated, and the list is updated.

5 When finished, return to the Accessory menu screen by pressing the END button, or press and hold the END button to return to the Home screen.



Gear ratio chart

The Gear Ratio Chart can be calculated from input values for the number of teeth of the spur gear and pinion gear and second gear ratio and displayed as a table.

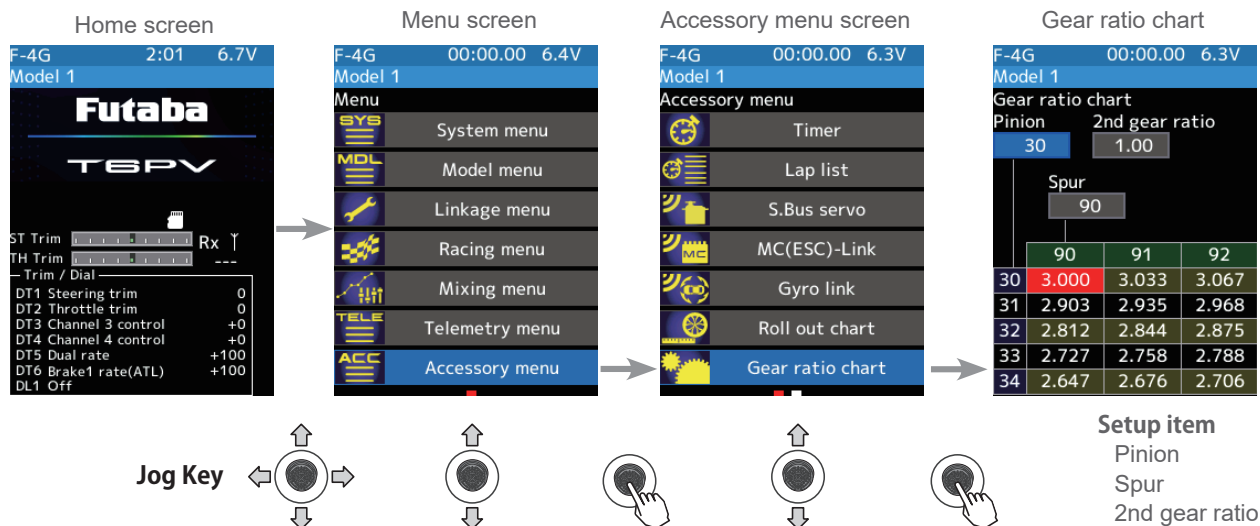

Gear ratio chart function

- (Setting of number of teeth of pinion gear)
 Select the value with jog key of the [Pinion]. Use the [+] or [-] button to set the pinion gear. The gear ratio is then calculated, and the list is updated.

Pinion	2nd gear ratio		
30	1.00		
Spur			
	90	91	92
30	3.000	3.033	3.067
31	2.903	2.935	2.968
32	2.812	2.844	2.875
33	2.727	2.758	2.788
34	2.647	2.676	2.706

- Adjustment buttons**
- Adjust with the [+] or [-] button.
 - Return to the initial value by press the [+] and [-] button simultaneously

- (Setting of number of 2nd gear ratio)
 Select the value with jog key of the [2nd gear ratio]. Use the [+] or [-] button to set the 2nd gear ratio. The gear ratio is then calculated, and the list is updated.
- (Setting of number of teeth of spur gear)
 Select the value with jog key of the [Spur]. Use the [+] or [-] button to set the spur gear. The gear ratio is then calculated, and the list is updated.
- When finished, return to the Accessory menu screen by pressing the END button, or press and hold the END button to return to the Home screen.



ACCESSORY MENU



END/DIR button setting

The END/DIR button can be used to call up the desired screen from the home screen.

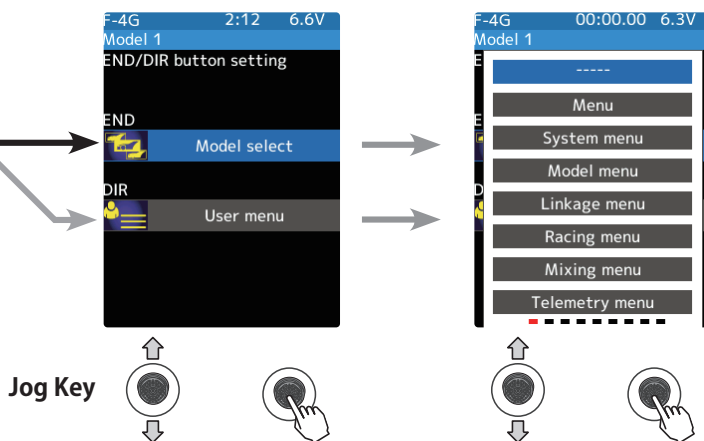
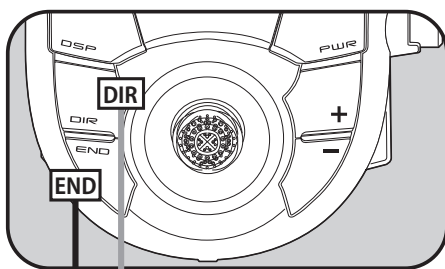
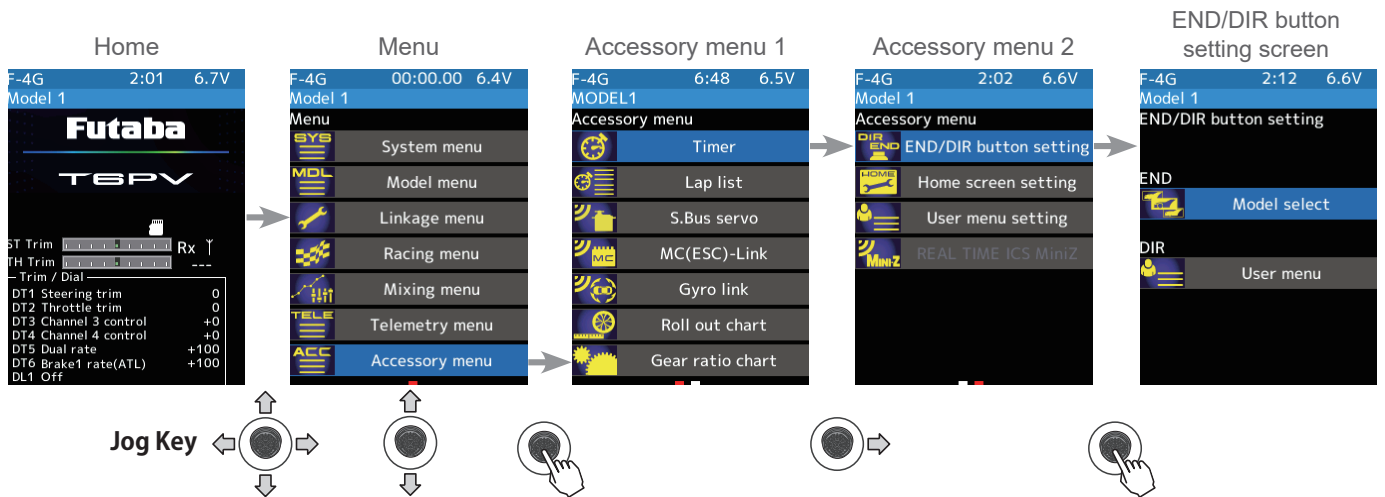

END/DIR button call settings

You can select the display of a specific function screen. Select from the list of functions by using the jog key.

There are multiple pages, so use the jog key to the right or left to move between pages.





ACCESSORY MENU



Home screen setting

You can choose to display the home screen.

- Normal
- Servo view
- Timer
- Instrument panel

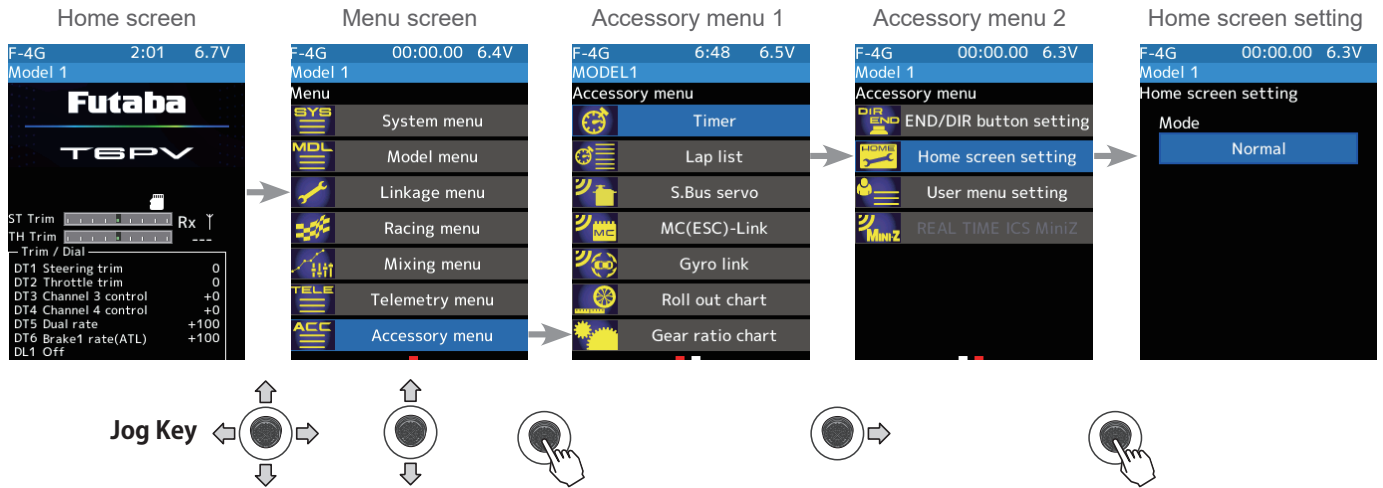

How to set the home screen display

1 Use the jog key to move the cursor to [Mode]. Press the [+] or [-] button to change it.

● Normal

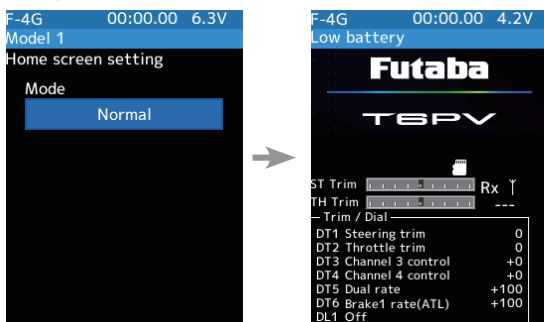

● Servo view

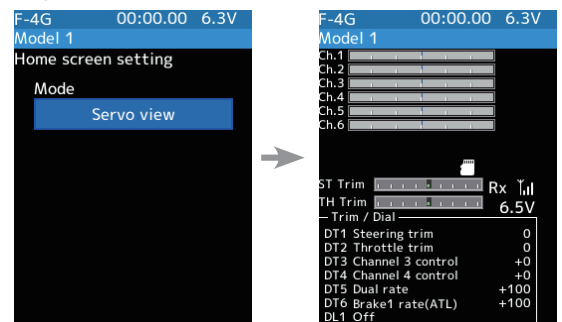

● Timer

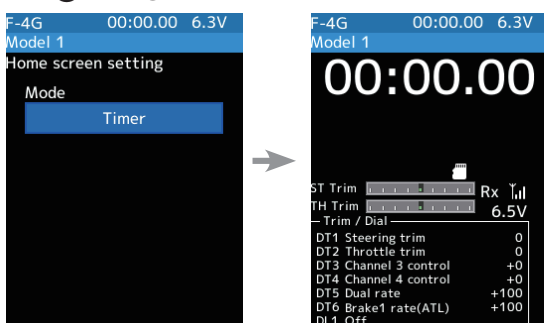

● Instrument panel

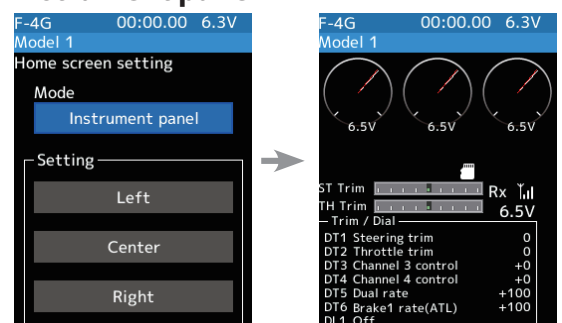

Instrument panel selection

- 1 Select **[Instrumental Panel]** in the home screen display settings.

Use the jog key to move the cursor to **[Mode]** and use the **[+]** or **[-]** button to select **[Instrumental Panel]**.

Home screen setting

F-4G 00:00.00 6.3V
Model 1
Home screen setting
Mode
Instrument panel
Setting
Left
Center
Right

F-4G 00:00.00 6.3V
Model 1
Home screen setting
Mode
Instrument panel
Setting
Left
Center
Right

F-4G 00:00.00 6.3V
Model 1
Instrument panel
Display ON OFF
Sensor
0 Receiver
Value type
Battery
Max. 10.0V
Min. 0.0V
min./max. Reset

F-4G 00:00.00 6.3V
Model 1
Instrument panel
Display ON OFF
Sensor
Steering
Value type
Battery
Max. 10.0V
Min. 0.0V
min./max. Reset

F-4G 00:00.00 6.3V
Model 1
Instrument panel
Display ON OFF
Sensor
Throttle
Value type
Battery
Max. 10.0V
Min. 0.0V
min./max. Reset

F-4G 00:00.00 6.3V
Model 1
Instrument panel
Display ON OFF
Sensor
1 MC/Acuance
Value type
ESC Temp.
Max. 100°C
Min. 0°C
min./max. Reset

F-4G 00:00.00 6.3V
Model 1
Steering
Throttle
Brake
0 Receiver
1 MC/Acuance

F-4G 00:00.00 6.3V
Model 1
Steering
Throttle
Brake
0 Receiver
1 MC/Acuance

F-4G 00:00.00 6.3V
Model 1
Steering
Throttle
Brake
0 Receiver
1 MC/Acuance

F-4G 00:00.00 6.3V
Model 1
Steering
Throttle
Brake
0 Receiver
1 MC/Acuance

The display can be turned ON/OFF for each meter.

Steering:
Meter display follows steering wheel operation

Throttle :
The meter displays the throttle trigger forward.

Various sensors :
Telemetry data displayed on meters

Use the jog key to select the maximum/minimum value displayed on the meter, then press the **[+]** or **[-]** button to set it.

- 2 When finished, return to the Accessory menu screen by pressing the END button, or press and hold the END button to return to the Home screen.



ACCESSORY MENU



User menu setting

You can create your own functions for frequently used functions.

The custom menu editing screen can be displayed in the following way.

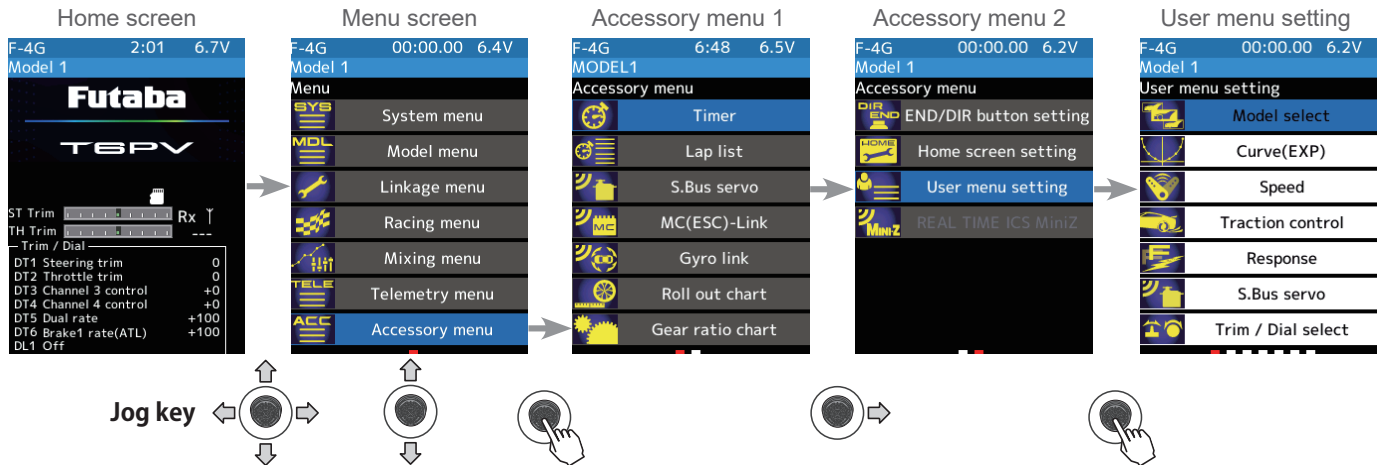

Example of setting the first line

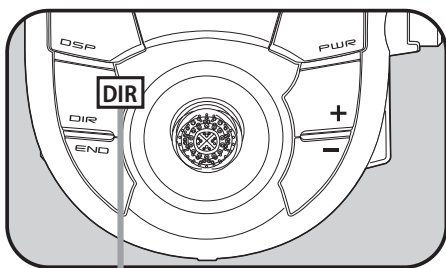
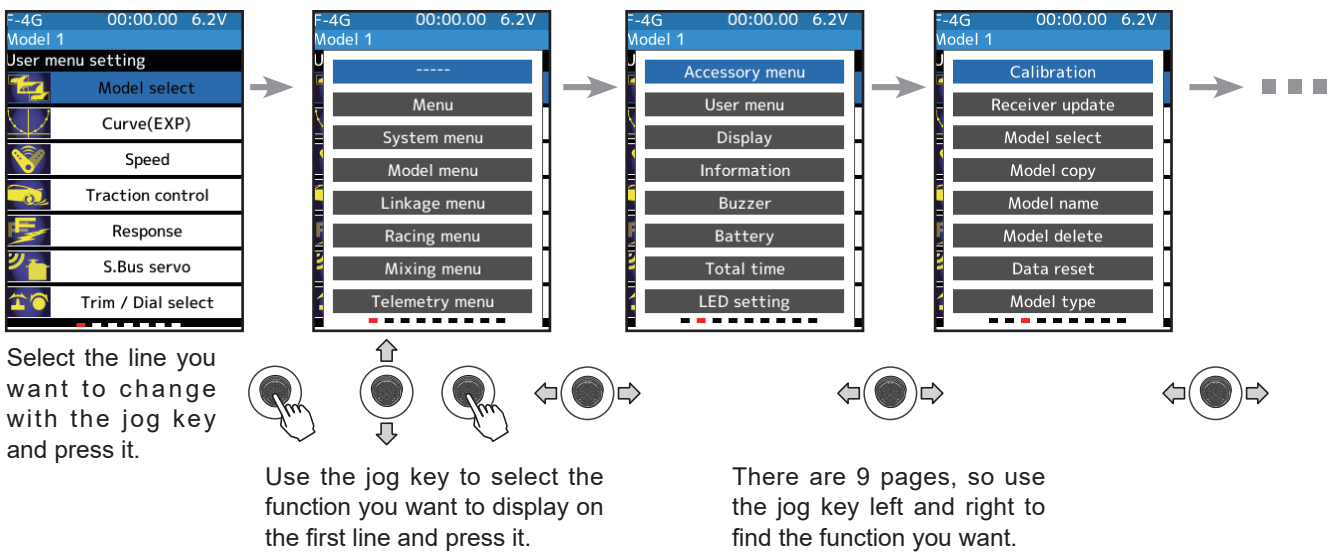

You can press the DIR button on the home screen to display the custom menu you created.





ACCESSORY MENU



REAL TIME ICS MiniZ

REAL TIME ICS MiniZ setting

*This function is limited to when the system is MINI-Z EVO2 and [Bi-Dir] is ON.

When the telemetry function of the Kyosho MINI-Z EVO2 is turned on, it is possible to change the parameters of the MR-04 chassis.

- 1 Set the transmitter "PWR" side power switch to ON. From the Home screen, operates the jog key. Next, select [REAL TIME ICS MiniZ] at the Accessory menu page 2 and access the setup screen shown below by press the jog key.

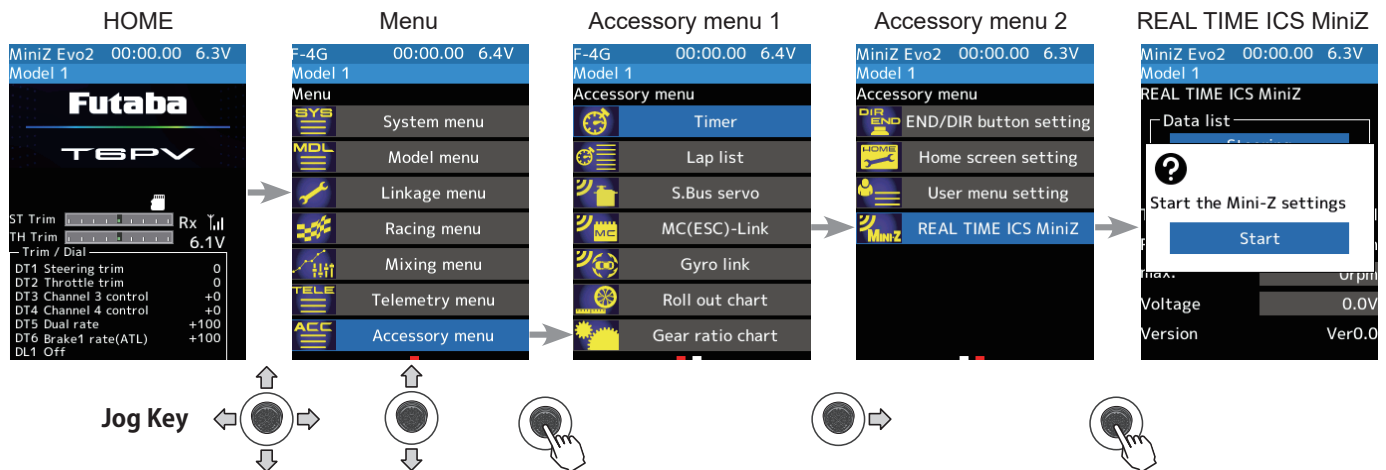

- 2 Pressing the jog key [Start] to display information from the chassis.

Response: Slow

Motor type: Unlimited
Rotation: 0rpm
max.: 0rpm
Voltage: 5.8V
Version: Ver1.0

Response: Fast

Motor type: Unlimited
Version: Ver1.0

Display when response is Slow
(Linkage menu → Receiver → System)

- Motor type REAL TIME ICS MiniZ is display only.
Use the ICS manager to set this.
- Rotation Displays the current RPM of the motor.
- max. Displays the maximum motor RPM.
Pressing the jog key while the cursor is on this number will reset it.
- Voltage Displays the car's current battery voltage.
When the cursor is on this number, pressing the jog key will jump to the setting screen.
- Version The chassis version is displayed.

Display when response is Fast
(Linkage menu → Receiver → System)

No telemetry information is displayed.

3 Use the jog key to place the cursor on [Steering] and press it to set steering parameters from the transmitter.

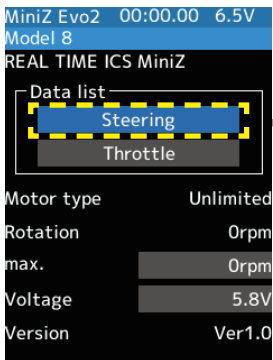

- ST Power : L (Setting of holding characteristics near neutral) 1 ~ 5
- ST Power : H (Setting of retention characteristics for ranges other than power low) 1 ~ 5
- ST Speed (Maximum steering speed setting) Slow, 2 ~ 4, Fast
- Punch (Initial response settings) 1 ~ 20
- Neutral (Neutral zone settings) 0 ~ 10
- Damping (Brake characteristic setting) Over, Middle, Smooth



Use the jog key to select the setting value for each item and set it with the [+] or [-] button. Setting with the [+] or [-] button is immediately reflected on the car.

4 Use the jog key to place the cursor on [Throttle] and press it to set throttle parameters from the transmitter.

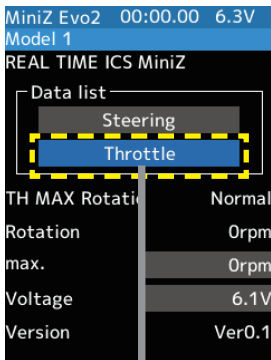

Throttle 1 page



When you touch the No Backwheel and Brushless items, a confirmation screen will appear. Select "Yes" with the jog key and press it to make the change.

- Reverse limit OFF(with reverse)/ON(without reverse)
- Brushless (Selection of motor type) ON(Brushless motor)/OFF(Brushed Motor)
- Reverse timer (Time lag to start reverse) Slow: 2.8ms~700ms Fast: 0.99ms~250ms
- Neutral brake (Braking in neutral) 1 ~ 5
- Motor time constant (Motor start-up time) 1 ~ 5
- Curve control (Response to throttle opening) Minus, Flat, Plus
- FWD punch (Throttle initial response setting) 0 ~ 10



Throttle 2 page



- Neutral Range (Neutral zone setting) Narrow, Middle, Wide
- Motor Timing 0-8 *MiniZ initial version did not have this setting.

Use the jog key to select the setting value for each item and set it with the [+] or [-] button. Setting with the [+] or [-] button is immediately reflected on the car.

Warning displays

Low Battery Alarm

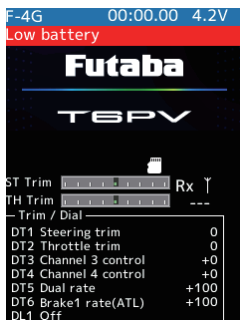

If the transmitter battery voltage drops below the usable range, an audible alarm will sound and "Low battery" will be displayed. Since the usable range of LiPo, LiFe and Ni-MH batteries are different, the power supply used must be set by the system setting.

Audible alarm: Continuous tone.

Warning

ⓘ When a low battery alarm is generated, cease operation immediately and retrieve the model.

If the battery goes dead while in operation, you will lose control.

Power off forgotten alarm

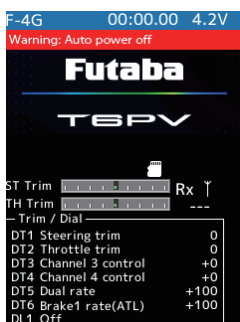

At T6PV initialization, if steering wheel, throttle trigger, push switch, HOME button, or other operation is not performed within 10 minutes, an audible alarm will sound and the message "Warning: Auto power off" will appear. If steering wheel, throttle trigger, push switch, HOME button or other operation is performed, the alarm is reset. Also, turn off the power when the transmitter is not in use. If you do not want to use this alarm and the auto power off function, they can be disabled by **System menu** → **Battery** → **Auto power off**

Audible alarm: Continuous tone.

- If the alarm is not reset, the auto power off function will automatically turn off the power after 5 minutes.

MIX Warning

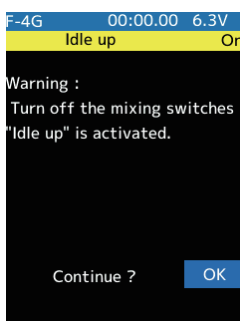

When the power switch is turned on while the idle-up, engine cut, or neutral brake function switch is on, an audible alarm will sound, and "Warning" will be displayed on the LCD. When that function switch is turned off, the alarm will stop.

Audible alarm: Continuous tone.

- The alarm stops even if the [OK] is press jog key. However, check the function switch.

WARRANTY & REPAIR service (IN U.S.A.)

Technical updates and additional programming examples can be found at: www.futabausa.com

(Information needed for repair)

If any difficulties are encountered while setting up or operating your T6PV, please consult the instruction manual first. For further assistance you may also refer to your hobby dealer or contact the Futaba Service Center at the e-mail address, fax or telephone number listed below:

Phone:1-256-461-9399, FAX:1-256-461-1059

E-Mail: contactus@futaba.com

If you are unable to resolve the issue, pack the system in its original container with a note enclosed and a thorough, accurate description of the difficulty. Include the following in your note:

- Symptoms (including when the problem occurred)
- System (Transmitter, Receiver, Servos and model numbers)
- Model (Model name)
- Your Name, Address and Telephone number

Send the respective items to the authorized Futaba Service Center Address below:

Futaba Corporation of America
2681 Wall Triana Hwy
Huntsville, AL 35824, U.S.A.

(Warranty)

Read the Warranty card.

- When requesting warranty service, send the card or some type of dated proof purchase.

This product uses the following open source software.

- **Google Noto Fonts**
<https://github.com/googlefonts/noto-fonts/blob/main/LICENSE>
- **Newlib**
<https://sourceware.org/newlib/COPYING.NEWLIB>

- No part of this manual may be reproduced in any form without prior permission.
- The contents of this manual are subject to change without prior notice.
- This manual has been carefully written. Please write to Futaba if you feel that any corrections or clarifications should be made.
- Futaba is not responsible for the use of this product.

©Copyright 2025. No part of this manual may be reproduced in any form without prior permission. The contents of this manual are subject to change without prior notice. While this manual has been carefully written, there may be inadvertent errors or omissions. Please contact our service center if you feel that any corrections or clarifications should be made.

FUTABA CORPORATION
1080 Yabutsuka, Chosei-mura, Chosei-gun, Chiba-ken, 299-4395, Japan
TEL: +81-475-32-6051, FAX: +81-475-32-2915

©FUTABA CORPORATION 2025, 1 (1)





Futaba®