

# Futaba Rate Gyro for Airplanes

## Aileron or Elevator use

# GYA441

### INSTRUCTION MANUAL

For RC models

Before using your new gyro, please read this manual thoroughly and use the gyro properly and safely. After reading this manual, store it in a safe place.

- No part of this manual may be reproduced in any form without prior permission.
- The contents of this manual are subject to change without prior notice.
- Futaba is not liable for any potential damage (accidental or otherwise) that may occur after installation.

### Features of GYA441

- Dedicated airplane setting**  
Stabilizes flight, even with hard-to-control scale models.
- Compatible with aileron or elevator control**  
The GYA441 can be used even with airplanes with one servo each at the left and right wings (S.BUS only)
- Remote gain function**  
The remote gain function allows the sensitivity of the gyro to be adjusted from the transmitter and the mode switching function allows AVCS/NORMAL gyro mode switching. Also the gain can be adjusted by the trimmer on the GYA441.
- Integrated type, compact size and light weight**  
High-density mounting technology makes the GYA441 compact (20.5 x 20.5 x 11 mm) and lightweight (3.7 g).
- Easy setup**  
Basic settings let you be flight-ready in an instant.
- Supporting the S.BUS/S.BUS2 connection**  
Only one wire connection to the receiver can operate the GYA441.

### Name and Function of Each Part

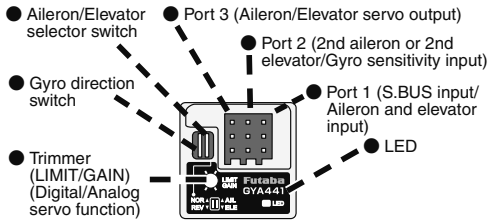

Monitor LED display			
Operation status	Color	Display	Remarks
1. No servo pulse / sensor error	Red	4 flash	
2. Start of initialization	Green	Fast blink	
3. End of initialization	Red/Green/Orange	Steady light	Servo Mode: Digital / Analog AVCS: Red / Red Normal: Orange / Green
4. Turn	Red/Green	Fast blink	Right (Green) Left (Red)
5. Neutral deviation	Orange	Slow blink	When stick operated
6. Gyro sensitivity zero	-	OFF	
7. Switch switching	Green	One blink	Each switching
8. Low battery	Red	One flash	When power drops to 3.8V or less

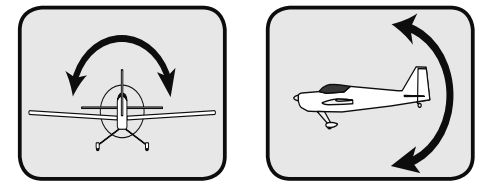

Thank you for purchasing the GYA441 airplane gyro. Compact and lightweight, the GYA441 is designed to control the ailerons (roll axis) or elevators (pitch axis). Features include simple set-up and S.BUS/S.BUS2 connectivity.

**GYA441 Ratings:**  
(Integrated sensor type rate gyro)

- Gyro sensor: MEMS vibrating structure gyro
- Operating voltage: DC4.0V to 8.4V
- Current drain: 30mA (excluding a servo)
- Operating temperature range: -10°C to +45°C
- Dimensions: 20.5 x 20.5 x 11.0mm (except protrusion)
- Weight: 3.7g
- Functions: (1) Gyro sensitivity trimmer, (2) Monitor LED, (3) Two servos compatibility, (4) S. BUS/S.BUS2 compatibility, (5) Digital / analog servo function

### Set Contents

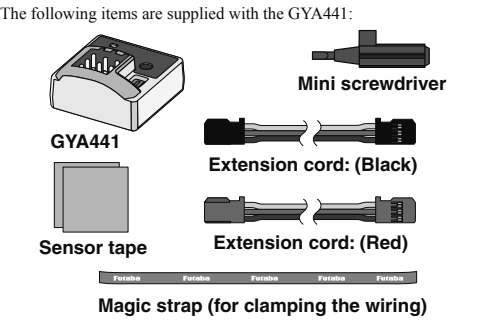

**WARNING**  
Failure to follow these safety precautions may result in severe injury to yourself and others.

- Check that there is sufficient transmitter battery capacity for flight.
- Determine the operating time of the receiver, gyro, and servo battery in the adjustment stage and decide the number of flights with a margin to spare.
- Analog servos cannot be used while in "digital servo" mode.
- Analog servos may break down if "digital servo" mode is selected.
- Do not operate the airplane and transmitter sticks for about 3-5 seconds after turning on the GYA441 (When shared with the receiver).
- GYA441 initialization and neutral position reading. The GYA441 is initialized when the power is turned on. In the AVCS mode, the neutral position is also read at the same time. If initialization ends normally, the operator is informed by two repetitive movements of the servo to the left and right (a little).
- Always check the direction of operation of the gyro.
- Attempting to fly with the operating direction reversed is extremely dangerous. Always check your gyro's direction to ensure safe flights.
- Do not strike the gyro with a hard object. Do not drop it onto a concrete surface or other hard floor.
- The sensor may become damaged during strong impacts.
- Do not use trims or mixing in AVCS mode.
- In the AVCS mode all corrections are made by the gyro. Therefore, if trimming and mixing, are turned on, operation will be the same as deviating from the neutral position.
- Do not use the GYA441 for applications other than RC airplanes.
- This gyro is designed for RC airplanes only. Do not use it for other applications.
- Do not place gyro near heating equipment (engine, motor, ESC, battery, servo, etc.).
- Always allow the gyro to adjust to the surrounding environmental temperature before flight. A large temperature change during use will cause drift and other operational issues.

### Connection

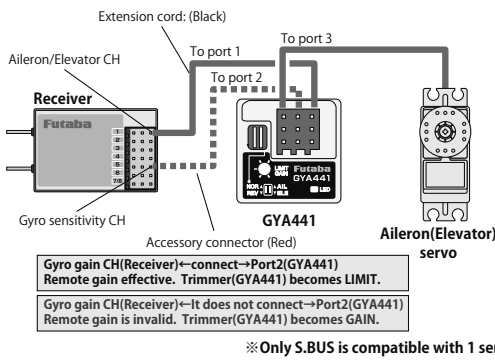

### S.BUS Connection

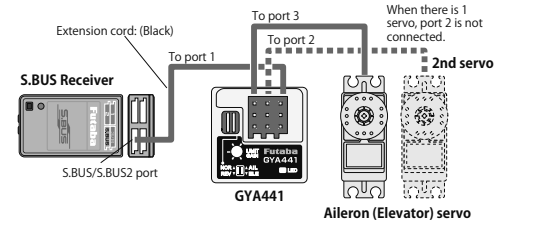

At S.BUS/S.BUS2 operation, the channels are fixed as shown in the table below. Match the transmitter channels to these.

Function	Aileron mode	Elevator mode
Aileron	CH1	
Elevator		CH2
2nd aileron	CH6	
2nd elevator		CH9
Gyro sensitivity (Aileron)	CH5	
Gyro sensitivity (Elevator)		CH7

### S.BUS 3-axes Connection Example

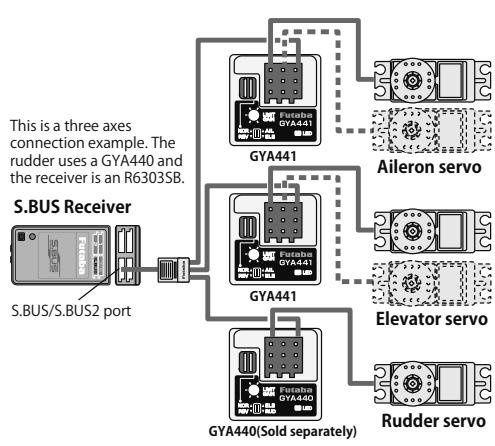

S.BUS connection makes the wiring extremely simple. The GYA440 and GYA441 can be connected by one 3-way hub. The aileron, elevator, and rudder servos are output from the gyro. Servos other than S.BUS servos can also be used. When an R6303SB is used the CH switching mode is set to group 7. The normal group 7 CH outputs are CH3, CH11, and CH12. CH3 is the throttle channel and CH11 and CH12 are spare channels.

The transmitter function settings are shown below. A total of 9 channels are used with three axes gyro control.

Function	GYA441 (aileron)	GYA441 (elevator)	GYA440 (rudder)
Aileron	CH1		
Elevator		CH2	
Rudder			CH4
2nd aileron	CH6		
2nd elevator		CH9	
Gyro sensitivity (aileron)	CH5		
Gyro sensitivity (elevator)		CH7	
Gyro sensitivity (rudder)			CH8

### Mounting to the Chassis

The gyro is very sensitive to vibration. Securely mount it with the included double-sided sponge tape at a position where vibration is minimal and the gyro is perpendicular to the axis to be controlled. Since double-sided tape will not stick to balsa, make a smooth surface by cementing a smooth plastic sheet. to the frame and securely attach the gyro with double-sided tape. Provide a surplus in the wiring and bundle the wiring with the included magic strap so that it will not interfere with the rod.

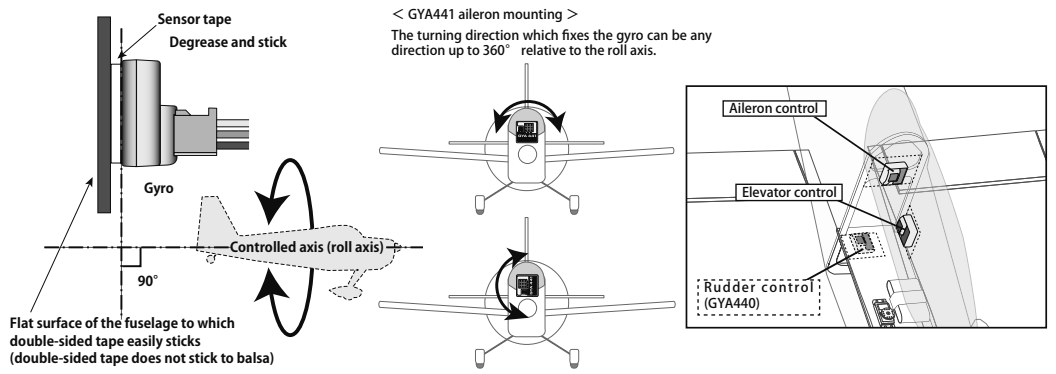

## Servo

Link the servo in accordance with the kit instruction manual. Adjust the linkage rod so that the trim amount is as small as possible.

<2nd servo operating direction>  
During aileron mode operation the 2nd aileron servo moves in the same direction as the aileron servo. In the elevator mode, the 2nd elevator servo moves in the opposite direction of the elevator servo. Mount the servos as left and right objective linkage.

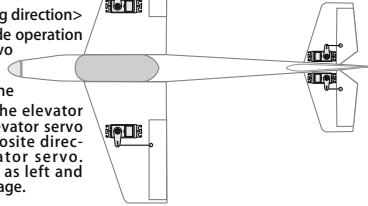

## Digital/Analog servo selection

Selection of an analog and digital servo is performed in a limit trimmer's setting position.

A limit trimmer's motion is as follows.

Digital servo → A trimmer is adjusted by the Right rotation from the middle point.

Analog servo → A trimmer is adjusted by the Left rotation from the middle point.

The amount of limits -- the halfway point -- the minimum -- it will become the maximum quantity if it is made to rotate to Max, respectively. The check of operational mode is discriminable in the display color of LED. The stability of digital-servo mode of a flight increases in order to perform a high-speed control action.

Selection of digital/analog servo is chosen towards a trimmer turning.

Digital-servo mode:  
LED Orange



Analog-servo mode:  
LED Green

[Limit position]

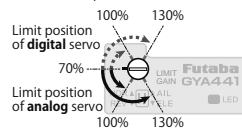

When a remote gain function is off, it becomes only analog servo mode. A trimmer becomes only for gain.

(Digital-servo use is possible)

\*When you use an analog servo, please be sure to set to analog servo mode. If it sets to digital-servo mode and it is operated, there is a danger that a servo will be destroyed.

## Preflight Adjustments

### Setup before a flight [ Remote gain use ]

Adjust the gyro sensitivity at the transmitter.

At S.BUS connection or when gyro port 2 and the gyro sensitivity CH of the receiver are connected

**1** Use the aileron/elevator selector switch to select aileron or elevator. (Aileron: AIL Elevator: ELE)

**2** Turn on your transmitter's power. Set the gyro sensitivity to about 50% at the normal side (minus rate side) in accordance with the transmitter instruction manual. 50% of normal sensitivity will be -70% at the rate of the sensitivity CH so that a next graph may be seen and understood.

Gyro sensitivity zero --- LED OFF  
AVCS side --- LED red  
NORMAL side --- LED green

**3** Turn on the receiver power. When the gyro starts the LED flashes green and initialization begins. When initialization ends the servo performs reciprocating operation to the left and right (a little).

This places the gyro into the ready state. During initialization secure the fuselage so that it will not move and fix the transmitter stick at the neutral position. Initialization takes about 3-5 seconds after the receiver operates. After initialization the LED lights green. If the neutral position has changed, the LED will light orange. In this case, restart the gyro. Move the stick and check that the servo operates.

**4** Move the stick to the maximum left and right and adjust the gyro limit trimmer so that the servo operating angle is at the maximum position at which there is no interference with the linkage.

### <Limit trimmer Adjustments>

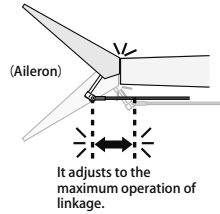
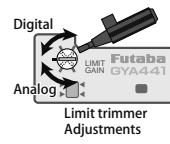

It adjusts to the maximum operation of linkage.

#### ● Trimmer operation

\*Make trimmer adjustments gently by using the included mini screwdriver.

**5** In the case of aileron control, switch the gyro direction switch and adjust the direction of operation of the gyro so that the ailerons move all the way to the right when the airplane is tilted to the left. In the case of elevator control, switch the gyro direction switch and adjust the direction of operation of the gyro so that the elevator servo moves in the down direction when the airplane is moved in the up direction. If the direction of operation of the gyro is incorrect, flight will become impossible so make the settings positively.

Tilt the airplane to the left on the ground and check that the ailerons operate to the right. (In the case of aileron control)

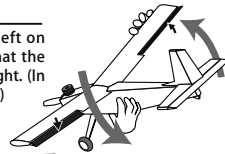

Tilt the airplane to the left on the ground and check that the ailerons operate to the right. (In the case of aileron control)

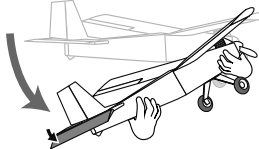

### [ When remote gain function is off ]

Adjust the gyro sensitivity with the GYA441 trimmer.

Do not use the AVCS mode.

All remote gains are effective at S.BUS connection. When port 2 is not connected when S.BUS is not used remote gain is inhibited. In this case, the limit trimmer is automatically changed to gyro sensitivity setting trimmer.

(Limit position is fixed at operating angle left and right 55°. A servo is fixed to analog mode.)

\* In this case, 2 gain setup with a transmitter and 4 limit adjustment of differing in a procedure are lost. And as shown in a figure, gain is adjusted of the trimmer of GYA441.

### < A gain trimmer's work >

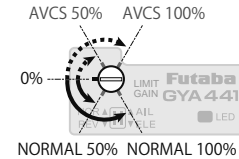

First, we recommend to start with NORMAL30%.

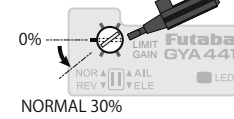

### Gyro Sensitivity and AVCS Switching

When the remote gain function is used normally and AVCS mode switching is performed in accordance with the direction of operation of the transmitter's remote gain channel. At the + rate side, the AVCS mode is selected and at the - rate side, the NORMAL mode is selected. The sensitivity is changed by adjusting the end point rate. If the transmitter has a gyro sensitivity setting mixing function, the sensitivity setting is performed directly.

When the remote gain function is not used, the clockwise direction from the center of the sensitivity setting trimmer is the AVCS mode (not used) and the counterclockwise direction is the NORMAL mode. At the center position, the sensitivity becomes zero. When the trimmer is turned fully to the left or right, the sensitivity becomes 100%.

The sensitivity setting criteria by end point is shown in the figure below. The sensitivity becomes zero between end point -40% to +40% and becomes 100% at end point 100%.

### < GAIN CH >

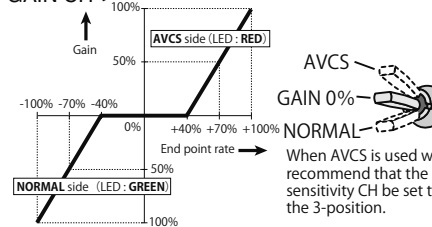

When AVCS is used we recommend that the sensitivity CH be set to the 3-position.

Refer to the transmitter instruction manual and set the end point. When AVCS is used, setting the 3-positions switch to the sensitivity CH (there are types which cannot be set by transmitter) and setting it as shown above is recommended. In the case of a 2-positions switch, inhibiting the gyro at 0% sensitivity such as NORMAL mode and sensitivity 0% and AVCS mode and 0% sensitivity is safe.

Trimmer movement when the remote gain function is not used (when S.BUS is not used and port 2 is not connected). Please do not use AVCS, when you do not use remote gain. Because, neutral memory cannot be performed. And taking off and landing being dangerous.

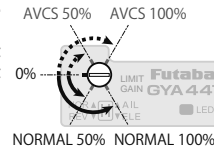

### Servo Operation on the Ground

If the stick is moved when the airplane is on the ground, the servo will move to the limit position. In the AVCS mode, the servo will not return to the neutral position even if the stick is set to the neutral position, but this is normal.

If the stick is moved fully to the left or right three or more times within one second, the servo will temporarily return to the neutral position.

## Flight Adjustment

Adjust the transmitter and gyro while repeatedly taking off and landing and with the aircraft on the ground.

Transmitter adjustments must not be made while flying because it is dangerous.

**1** Fly the aircraft and trim it by turning off the gyro at 0% sensitivity or in the NORMAL mode. After trimming, switch the gain switch between 0% sensitivity (or NORMAL mode) and the AVCS mode three times at an interval of within one second and then set the gain switch to the AVCS mode position. This memorizes the AVCS mode neutral trim position at the gyro. In the AVCS mode, do not perform trimming during flight.

**2** Adjust the gyro sensitivity so that hunting (deflection of the aircraft in small increments) does not occur in the control axis direction. The gyro sensitivity is different depending on the area of the aircraft rudder, air speed, and gyro used. Initially try changing the sensitivity in 5% steps. If hunting is excessive, the aircraft may be damaged. Hunting tends to stop when the airspeed is lowered.

## AVCS / NORMAL Modes

The gyro has two operation modes: NORMAL mode and AVCS mode. In the AVCS mode, angle control is performed at the same time as NORMAL mode rate (rotating speed) control. In the AVCS mode, the neutral keeping force is stronger than the NORMAL mode and the flight attitude of the aircraft is forcefully maintained. During knife-edge flying, idiosyncrasies of the aircraft when climbing will be compensated automatically. On the other hand since the rudder follows when the aircraft stalls, pay special attention to the elevator axis. To be safe, switching to the NORMAL mode when taking off and landing is recommended.

When GYA441 used at the ailerons of a shoulder wing aircraft

